



12115 - A Panchromatic Hubble Andromeda Treasury - I

Cycle: 20, Proposal Category: GO

(Large Program)

(Availability Mode: SUPPORTED)

INVESTIGATORS

<i>Name</i>	<i>Institution</i>	<i>E-Mail</i>
Dr. Julianne Dalcanton (PI) (Contact)	University of Washington	jd@astro.washington.edu
Dr. Eric F. Bell (CoI)	University of Michigan	ericbell@umich.edu
Dr. Luciana C. Bianchi (CoI)	The Johns Hopkins University	bianchi@pha.jhu.edu
Dr. Nelson C. Caldwell (CoI)	Smithsonian Institution Astrophysical Observatory	ncaldwell@cfa.harvard.edu
Dr. Andrew Dolphin (CoI)	Raytheon Company	adolphin@raytheon.com
Dr. Karoline Gilbert (CoI)	University of Washington	kgilbert@astro.washington.edu
Dr. Leo Girardi (CoI) (ESA Member)	Osservatorio Astronomico di Padova	leo.girardi@oapd.inaf.it
Ms. Stephanie Gogarten (CoI)	University of Washington	stephanie@astro.washington.edu
Dr. Karl D. Gordon (CoI)	Space Telescope Science Institute	kgordon@stsci.edu
Prof. Puragra Guhathakurta (CoI)	University of California - Santa Cruz	raja@ucolick.org
Dr. Paul W. Hodge (CoI)	University of Washington	hodge@astro.washington.edu
Dr. Jon A. Holtzman (CoI)	New Mexico State University	holtz@nmsu.edu
Mr. L. Johnson (CoI)	University of Washington	lcjohnso@astro.washington.edu
Dr. Jason S. Kalirai (CoI)	Space Telescope Science Institute	jkalirai@stsci.edu
Dr. C. S. Kochanek (CoI)	The Ohio State University	ckochanek@astronomy.ohio-state.edu
Dr. Dustin Lang (CoI)	Princeton University	dstn@cs.toronto.edu
Dr. Soeren S. Larsen (CoI) (ESA Member)	Universiteit Utrecht, Sterrekundig Instituut	s.larsen@astro.ru.nl
Dr. Tod R. Lauer (CoI)	National Optical Astronomy Observatory, AURA	lauer@noao.edu
Dr. Adam Leroy (CoI)	Associated Universities, Inc.	aleroy@nrao.edu
Dr. Jason Lee Melbourne (CoI)	California Institute of Technology	jmel@caltech.edu

Proposal 12115 (STScI Edit Number: 4, Created: Thursday, June 7, 2012 8:08:53 PM EST) - Overview

<i>Name</i>	<i>Institution</i>	<i>E-Mail</i>
Dr. Knut A.G. Olsen (CoI)	National Optical Astronomy Observatory, AURA	kolsen@noao.edu
Dr. Hans-Walter Rix (CoI) (ESA Member)	Max-Planck-Institut fur Astronomie, Heidelberg	rix@mpia.de
Mr. Keith Rosema (CoI)	Random Walk Group	krosema@comcast.net
Dr. Abhijit Saha (CoI)	National Optical Astronomy Observatory, AURA	saha@noao.edu
Dr. Ata Sarajedini (CoI)	University of Florida	ata@astro.ufl.edu
Dr. Anil C. Seth (CoI)	University of Utah	aseth@astro.utah.edu
Dr. Evan D. Skillman (CoI)	University of Minnesota - Twin Cities	skillman@astro.umn.edu
Dr. Krzysztof Z. Stanek (CoI)	The Ohio State University	kstanek@astronomy.ohio-state.edu
Dr. Daniel R. Weisz (CoI)	University of Washington	dweisz@astro.washington.edu
Dr. Benjamin F. Williams (CoI)	University of Washington	ben@astro.washington.edu

VISITS

<i>Visit</i>	<i>Targets used in Visit</i>	<i>Configurations used in Visit</i>	<i>Orbits Used</i>	<i>Last Orbit Planner Run</i>	<i>OP Current with Visit?</i>
01	(1) M31-B11-F01-IR (2) M31-B11-F01-UVIS (3) M31-B11-F04-WFC	ACS/WFC WFC3/IR WFC3/UVIS	2	07-Jun-2012 21:02:41.0	yes
02	(4) M31-B11-F02-IR (5) M31-B11-F02-UVIS (6) M31-B11-F05-WFC	ACS/WFC WFC3/IR WFC3/UVIS	2	07-Jun-2012 21:03:06.0	yes
03	(7) M31-B11-F03-IR (8) M31-B11-F03-UVIS (9) M31-B11-F06-WFC	ACS/WFC WFC3/IR WFC3/UVIS	2	07-Jun-2012 21:03:28.0	yes
04	(10) M31-B11-F04-IR (11) M31-B11-F04-UVIS (12) M31-B11-F01-WFC	ACS/WFC WFC3/IR WFC3/UVIS	2	07-Jun-2012 21:03:53.0	yes
05	(13) M31-B11-F05-IR (14) M31-B11-F05-UVIS (15) M31-B11-F02-WFC	ACS/WFC WFC3/IR WFC3/UVIS	2	07-Jun-2012 21:04:14.0	yes

Proposal 12115 (STScI Edit Number: 4, Created: Thursday, June 7, 2012 8:08:53 PM EST) - Overview

<i>Visit</i>	<i>Targets used in Visit</i>	<i>Configurations used in Visit</i>	<i>Orbits Used</i>	<i>Last Orbit Planner Run</i>	<i>OP Current with Visit?</i>
06	(16) M31-B11-F06-IR (17) M31-B11-F06-UVIS (18) M31-B11-F03-WFC	ACS/WFC WFC3/IR WFC3/UVIS	2	07-Jun-2012 21:04:34.0	yes
07	(19) M31-B11-F07-IR (20) M31-B11-F07-UVIS (21) M31-B11-F10-WFC	ACS/WFC WFC3/IR WFC3/UVIS	2	07-Jun-2012 21:04:54.0	yes
08	(22) M31-B11-F08-IR (23) M31-B11-F08-UVIS (24) M31-B11-F11-WFC	ACS/WFC WFC3/IR WFC3/UVIS	2	07-Jun-2012 21:05:15.0	yes
09	(25) M31-B11-F09-IR (26) M31-B11-F09-UVIS (27) M31-B11-F12-WFC	ACS/WFC WFC3/IR WFC3/UVIS	2	07-Jun-2012 21:05:38.0	yes
10	(28) M31-B11-F10-IR (29) M31-B11-F10-UVIS (30) M31-B11-F07-WFC	ACS/WFC WFC3/IR WFC3/UVIS	2	07-Jun-2012 21:05:58.0	yes
11	(31) M31-B11-F11-IR (32) M31-B11-F11-UVIS (33) M31-B11-F08-WFC	ACS/WFC WFC3/IR WFC3/UVIS	2	07-Jun-2012 21:06:18.0	yes
12	(34) M31-B11-F12-IR (35) M31-B11-F12-UVIS (36) M31-B11-F09-WFC	ACS/WFC WFC3/IR WFC3/UVIS	2	07-Jun-2012 21:06:38.0	yes
13	(37) M31-B11-F13-IR (38) M31-B11-F13-UVIS (39) M31-B11-F16-WFC	ACS/WFC WFC3/IR WFC3/UVIS	2	07-Jun-2012 21:06:58.0	yes
14	(40) M31-B11-F14-IR (41) M31-B11-F14-UVIS (42) M31-B11-F17-WFC	ACS/WFC WFC3/IR WFC3/UVIS	2	07-Jun-2012 21:07:21.0	yes

<i>Visit</i>	<i>Targets used in Visit</i>	<i>Configurations used in Visit</i>	<i>Orbits Used</i>	<i>Last Orbit Planner Run</i>	<i>OP Current with Visit?</i>
15	(43) M31-B11-F15-IR (44) M31-B11-F15-UVIS (45) M31-B11-F18-WFC	ACS/WFC WFC3/IR WFC3/UVIS	2	07-Jun-2012 21:07:41.0	yes
16	(46) M31-B11-F16-IR (47) M31-B11-F16-UVIS (48) M31-B11-F13-WFC	ACS/WFC WFC3/IR WFC3/UVIS	2	07-Jun-2012 21:08:01.0	yes
17	(49) M31-B11-F17-IR (50) M31-B11-F17-UVIS (51) M31-B11-F14-WFC	ACS/WFC WFC3/IR WFC3/UVIS	2	07-Jun-2012 21:08:20.0	yes
18	(52) M31-B11-F18-IR (53) M31-B11-F18-UVIS (54) M31-B11-F15-WFC	ACS/WFC WFC3/IR WFC3/UVIS	2	07-Jun-2012 21:08:40.0	yes

36 Total Orbits Used

ABSTRACT

We propose to image the north east quadrant of M31 to deep limits in the UV, optical, and near-IR. HST imaging should resolve the galaxy into more than 100 million stars, all with common distances and foreground extinctions. UV through NIR stellar photometry (F275W, F336W with WFC3/UVIS, F475W and F814W with ACS/WFC, and F110W and F160W with WFC3/NIR) will provide effective temperatures for a wide range of spectral types, while simultaneously mapping M31's extinction. Our central science drivers are to: understand high-mass variations in the stellar IMF as a function of SFR intensity and metallicity; capture the spatially-resolved star formation history of M31; study a vast sample of stellar clusters with a range of ages and metallicities. These are central to understanding stellar evolution and clustered star formation; constraining ISM energetics; and understanding the counterparts and environments of transient objects (novae, SNe, variable stars, x-ray sources, etc.). As its legacy, this survey adds M31 to the Milky Way and Magellanic Clouds as a fundamental calibrator of stellar evolution and star-formation processes for understanding the stellar populations of distant galaxies. Effective exposure times are 977s in F275W, 1368s in F336W, 4040s in F475W, 4042s in F814W, 699s in F110W, and 1796s in F160W, including short exposures to avoid saturation of bright sources. These depths will produce photon-limited images in the UV. Images will be crowding-limited in the optical and NIR, but will reach below the red clump at all radii. The images will reach the Nyquist sampling limit in F160W, F475W, and F814W.

OBSERVING DESCRIPTION

This is tiling brick 11 of the M31 MCTP.

The strategy is to obtain UV through IR photometry covering a large fraction of M31. Every primary target has a parallel target defined with the same coordinates, but with a different name to distinguish its location in the brick. Each visit is 2 orbits. During the two orbits, we obtain, 925, 1250, 1720, 1520, 699, and 1596 seconds of exposure in F275W, F336W, F475W, F814W, F110W, and F160W, respectively at summer orients (>180 degrees; Sched100). We obtain 1010, 1350, 1900, 1715, 799, and 1696 seconds of exposure in F275W, F336W, F475W, F814W, F110W, and F160W, respectively at winter orients (<180 degrees; Sched60). All exposure times are optimized to have the shutters of both cameras open during all buffer dumps. Thus, the exposure times are somewhat asymmetric. Orbit lengths for the orients available in winter are slightly longer than those for orients available in summer to maximize efficiency.

In the first orbit, WFC3/UVIS and ACS run in parallel to obtain 2 primary exposures in F275W, 2 primary exposures in F336W, and 4 parallel exposures in F814W. There is a pointing offset to all UVIS exposures to compensate for the V2, V3 offset between the IR-FIX aperture and the UVIS-CENTER aperture; including this offset keeps the ACS parallels aligned between the two orbits. Dithers are set up to obtain Nyquist sampling in F814W and cover the UVIS chip gap in F275W and F336W. With at least 2 exposures per filter, should allow all data to be cleaned of cosmic rays except for the UVIS chip gap, which will only have single-exposure coverage. A single short exposure is performed in F814W to protect against saturation.

In the second orbit, WFC/IR and ACS run in parallel to obtain 4 primary exposures in F160W, 1 primary exposure in F110W, and 5 parallel exposures in F475W. WFC/IR observations are performed during the second orbit of the visits in order to avoid any persistence issues in case the program observed before our observation uses the IR channel on a bright source. Dithers are set up to obtain Nyquist sampling in F475W and in F160W. A single short exposure is performed in F475W to protect against saturation. WFC3/IR exposures use variations of the STEP100 and STEP200 readout patterns, which protects against saturation in the IR. The F160W exposures use NSAMP=11, SAMP-SEQ=STEP100 (499s) and NSAMP=9, SAMP-SEQ=STEP200 (399s), and the F110W exposure uses NSAMP=11, SAMP-SEQ=STEP200 (799s, long orbit) and NSAMP=13, SAMP-SEQ=STEP100 (699s, short orbit).

ADDITIONAL COMMENTS

This brick has a priority value of 23 out of 23.

Proposal 12115 - Visit 01 - A Panchromatic Hubble Andromeda Treasury - I

Fri Jun 08 01:08:54 GMT 2012

Visit	Proposal 12115, Visit 01, implementation Diagnostic Status: Warning Scientific Instruments: WFC3/IR, WFC3/UVIS, ACS/WFC Special Requirements: SCHED 60%: ORIENT 54D TO 54 D					
Diagnostics	(Visit 01) Warning (Orbit Planner): PARALLELS SIGNIFICANTLY EXTEND ALIGNMENT TIME (Visit 01) Warning (Form): The 'SCHED=100' special requirement must be selected for this visit. (Visit 01) Warning (Orbit Planner): VISIBILITY OVERRUN					
Fixed Targets	#	Name	Target Coordinates	Targ. Coord. Corrections	Fluxes	Miscellaneous
	(1)	M31-B11-F01-IR	RA: 00 45 2.6832 (11.2611800d) Dec: +41 41 39.08 (41.69419d) Equinox: J2000		V=20+/-0.1	Reference Frame: ICRS
	(2)	M31-B11-F01-UVIS	RA: 00 45 2.6832 (11.2611800d) Dec: +41 41 39.08 (41.69419d) Equinox: J2000		V=20+/-0.1	Reference Frame: ICRS
	(3)	M31-B11-F04-WFC	RA: 00 45 2.6832 (11.2611800d) Dec: +41 41 39.08 (41.69419d) Equinox: J2000		V=20+/-0.1	Reference Frame: ICRS

Proposal 12115 - Visit 01 - A Panchromatic Hubble Andromeda Treasury - I

#	Label	Target	Config,Mode,Aperture	Spectral Els.	Opt. Params.	Special Reqs.	Groups	Exp. Time/[Actual Dur.]	Orbit	
Exposures	1	M31-B11-F 01-UVIS-F3 36W	(2) M31-B11-F01-U VIS	WFC3/UVIS, ACCUM, UVIS-CENTER	F336W	CR-SPLIT=NO	POS TARG 1.655,2. 96	Prime + Parallel Gro up 1-2 in Visit 01	550 Secs [==>]	[1]
	2	M31-B11-F 04-WFC-F8 14W-short	(3) M31-B11-F04-W FC	ACS/WFC, ACCUM, WFC	F814W			Prime + Parallel Gro up 1-2 in Visit 01	15 Secs [==>]	[1]
	3	M31-B11-F 01-UVIS-F2 75W	(2) M31-B11-F01-U VIS	WFC3/UVIS, ACCUM, UVIS-CENTER	F275W	CR-SPLIT=NO	POS TARG 1.655,2. 96	Prime + Parallel Gro up 3-4 in Visit 01	350 Secs [==>]	[1]
	4	M31-B11-F 04-WFC-F8 14W	(3) M31-B11-F04-W FC	ACS/WFC, ACCUM, WFC	F814W			Prime + Parallel Gro up 3-4 in Visit 01	350 Secs [==>]	[1]
	5	M31-B11-F 01-UVIS-F3 36W	(2) M31-B11-F01-U VIS	WFC3/UVIS, ACCUM, UVIS-CENTER	F336W	CR-SPLIT=NO	POS TARG 1.634,4. 882	Prime + Parallel Gro up 5-6 in Visit 01	800 Secs [==>]	[1]
	6	M31-B11-F 04-WFC-F8 14W	(3) M31-B11-F04-W FC	ACS/WFC, ACCUM, WFC	F814W			Prime + Parallel Gro up 5-6 in Visit 01	800 Secs [==>]	[1]
	7	M31-B11-F 01-UVIS-F2 75W	(2) M31-B11-F01-U VIS	WFC3/UVIS, ACCUM, UVIS-CENTER	F275W	CR-SPLIT=NO	POS TARG 1.525,4. 882	Prime + Parallel Gro up 7-8 in Visit 01	660 Secs [==>]	[1]
	8	M31-B11-F 04-WFC-F8 14W	(3) M31-B11-F04-W FC	ACS/WFC, ACCUM, WFC	F814W			Prime + Parallel Gro up 7-8 in Visit 01	550 Secs [==>]	[1]
	9	M31-B11-F 01-IR-f160 w	(1) M31-B11-F01-IR	WFC3/IR, MULTIACCUM, IR-FIX	F160W	NSAMP=9; SAMP-SEQ=STEP2 00	POS TARG 0,0	Prime + Parallel Gro up 9-10 in Visit 01	[==>]	[2]
	10	M31-B11-F 04-WFC-F4 75W-short	(3) M31-B11-F04-W FC	ACS/WFC, ACCUM, WFC	F475W			Prime + Parallel Gro up 9-10 in Visit 01	10 Secs [==>]	[2]
	11	M31-B11-F 01-IR-f110 w	(1) M31-B11-F01-IR	WFC3/IR, MULTIACCUM, IR-FIX	F110W	NSAMP=11; SAMP-SEQ=STEP2 00	POS TARG 0.187,0. 086	Prime + Parallel Gro up 11-12 in Visit 01	[==>]	[2]
	12	M31-B11-F 04-WFC-F4 75W	(3) M31-B11-F04-W FC	ACS/WFC, ACCUM, WFC	F475W			Prime + Parallel Gro up 11-12 in Visit 01	700 Secs [==>]	[2]
	13	M31-B11-F 01-IR-f160 w	(1) M31-B11-F01-IR	WFC3/IR, MULTIACCUM, IR-FIX	F160W	NSAMP=9; SAMP-SEQ=STEP2 00	POS TARG 0.206,0. 171	Prime + Parallel Gro up 13-14 in Visit 01	[==>]	[2]
	14	M31-B11-F 04-WFC-F4 75W	(3) M31-B11-F04-W FC	ACS/WFC, ACCUM, WFC	F475W			Prime + Parallel Gro up 13-14 in Visit 01	360 Secs [==>]	[2]
	15	M31-B11-F 01-IR-f160 w	(1) M31-B11-F01-IR	WFC3/IR, MULTIACCUM, IR-FIX	F160W	NSAMP=9; SAMP-SEQ=STEP2 00	POS TARG 0.263,0. 188	Prime + Parallel Gro up 15-16 in Visit 01	[==>]	[2]
	16	M31-B11-F 04-WFC-F4 75W	(3) M31-B11-F04-W FC	ACS/WFC, ACCUM, WFC	F475W			Prime + Parallel Gro up 15-16 in Visit 01	360 Secs [==>]	[2]
	17	M31-B11-F 01-IR-f160 w	(1) M31-B11-F01-IR	WFC3/IR, MULTIACCUM, IR-FIX	F160W	NSAMP=11; SAMP-SEQ=STEP1 00	POS TARG 0.204,-0 .001	Prime + Parallel Gro up 17-18 in Visit 01	[==>]	[2]
	18	M31-B11-F 04-WFC-F4 75W	(3) M31-B11-F04-W FC	ACS/WFC, ACCUM, WFC	F475W			Prime + Parallel Gro up 17-18 in Visit 01	470 Secs [==>]	[2]

Orbit 1

Server Version: 20120604

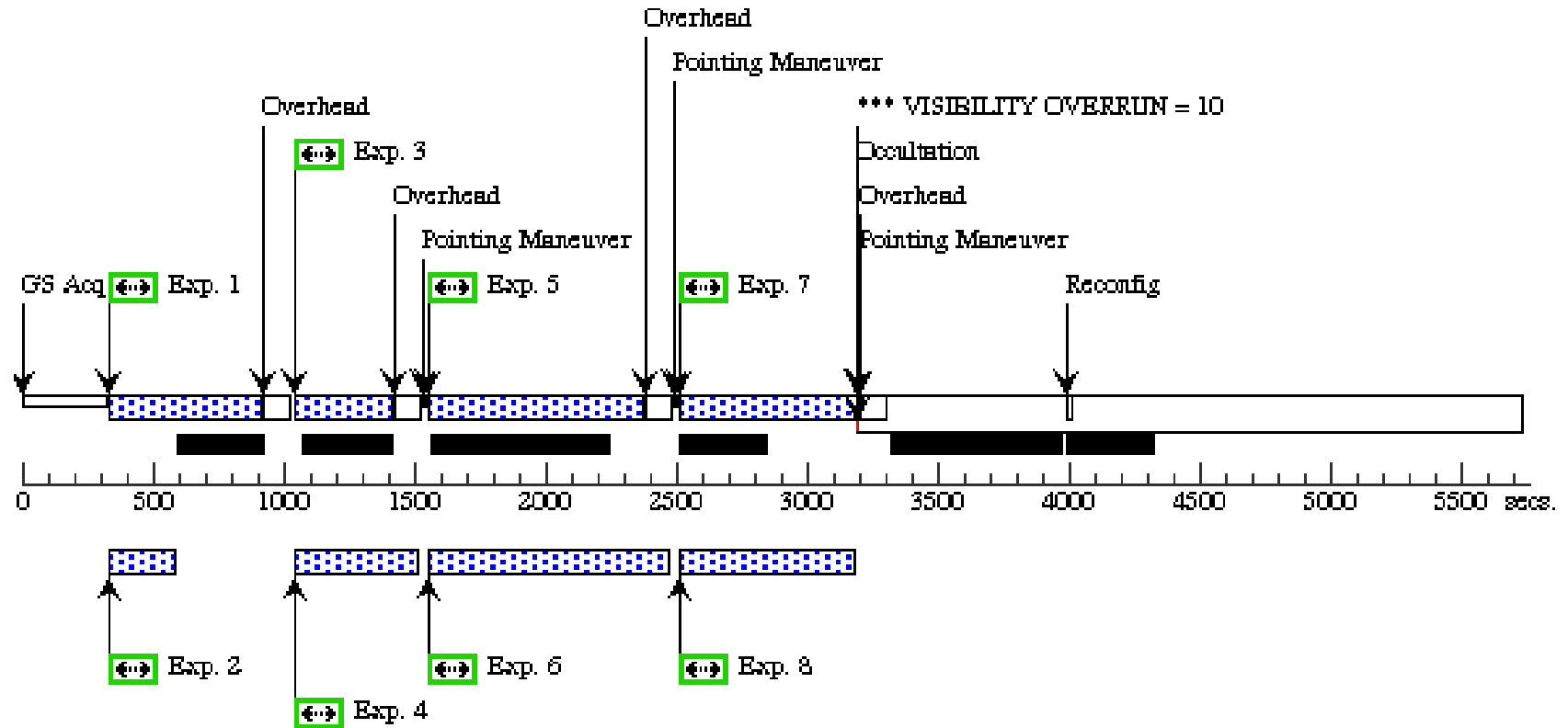

Orbit Structure

Orbit 2

Server Version: 20120604

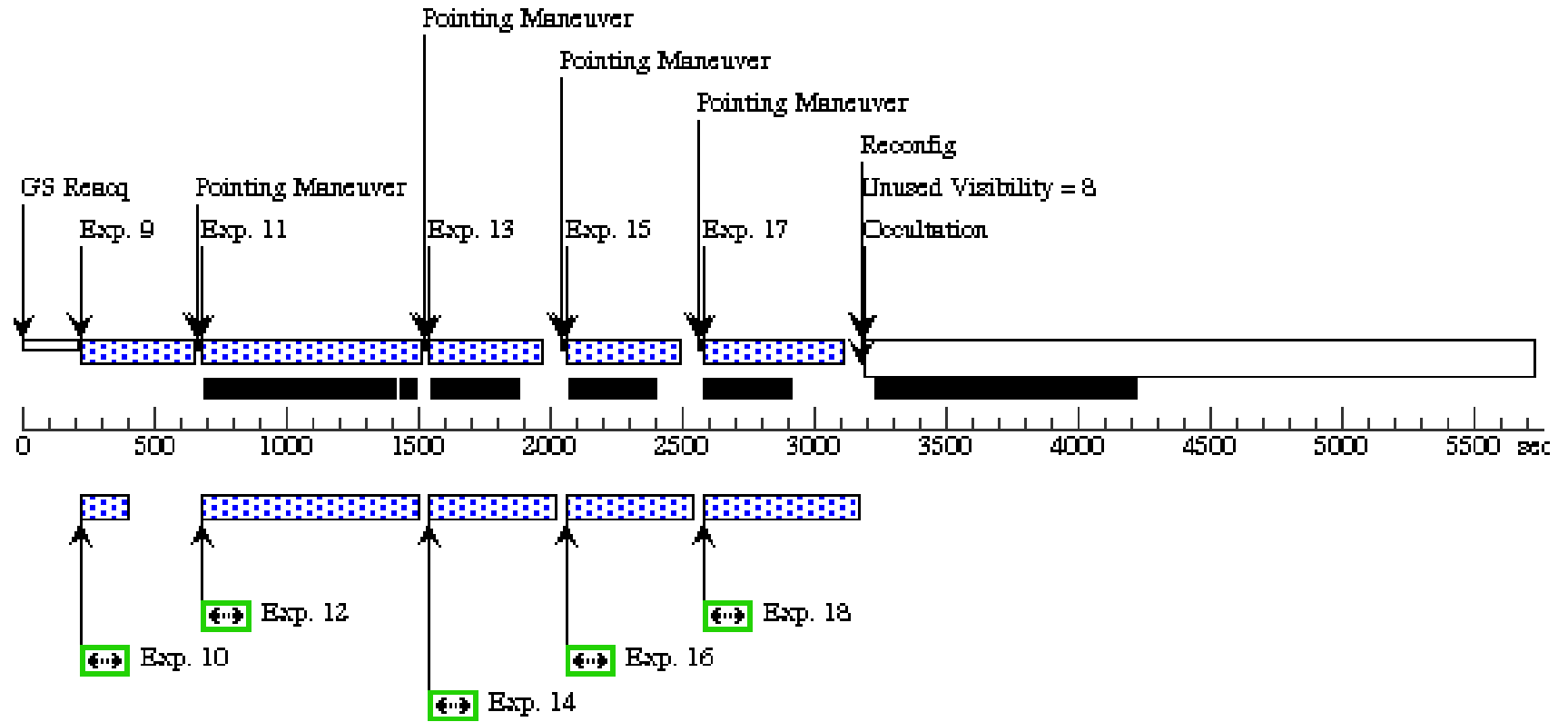

Proposal 12115 - Visit 02 - A Panchromatic Hubble Andromeda Treasury - I

Fri Jun 08 01:08:58 GMT 2012

Visit	Proposal 12115, Visit 02, implementation Diagnostic Status: Warning Scientific Instruments: WFC3/IR, WFC3/UVIS, ACS/WFC Special Requirements: SCHED 60%: ORIENT 54D TO 54 D					
Diagnostics	(Visit 02) Warning (Orbit Planner): VISIBILITY OVERRUN (Visit 02) Warning (Form): The 'SCHED=100' special requirement must be selected for this visit. (Visit 02) Warning (Orbit Planner): PARALLELS SIGNIFICANTLY EXTEND ALIGNMENT TIME					
Fixed Targets	#	Name	Target Coordinates	Targ. Coord. Corrections	Fluxes	Miscellaneous
	(4)	M31-B11-F02-IR	RA: 00 44 52.2111 (11.2175462d) Dec: +41 41 57.67 (41.69935d) Equinox: J2000		V=20+/-0.1	Reference Frame: ICRS
	(5)	M31-B11-F02-UVIS	RA: 00 44 52.2111 (11.2175462d) Dec: +41 41 57.67 (41.69935d) Equinox: J2000		V=20+/-0.1	Reference Frame: ICRS
	(6)	M31-B11-F05-WFC	RA: 00 44 52.2111 (11.2175462d) Dec: +41 41 57.67 (41.69935d) Equinox: J2000		V=20+/-0.1	Reference Frame: ICRS

Proposal 12115 - Visit 02 - A Panchromatic Hubble Andromeda Treasury - I

#	Label	Target	Config,Mode,Aperture	Spectral Els.	Opt. Params.	Special Reqs.	Groups	Exp. Time/[Actual Dur.]	Orbit	
Exposures	1	M31-B11-F02-UVIS-F3 VIS 36W	(5) M31-B11-F02-U VIS	WFC3/UVIS, ACCUM, UVIS-CENTER	F336W	CR-SPLIT=NO	POS TARG 1.655,2.96	Prime + Parallel Group 1-2 in Visit 02	550 Secs [==>]	[1]
	2	M31-B11-F05-WFC-F8 FC 14W-short	(6) M31-B11-F05-W FC	ACS/WFC, ACCUM, WFC	F814W			Prime + Parallel Group 1-2 in Visit 02	15 Secs [==>]	[1]
	3	M31-B11-F02-UVIS-F2 VIS 75W	(5) M31-B11-F02-U VIS	WFC3/UVIS, ACCUM, UVIS-CENTER	F275W	CR-SPLIT=NO	POS TARG 1.655,2.96	Prime + Parallel Group 3-4 in Visit 02	350 Secs [==>]	[1]
	4	M31-B11-F05-WFC-F8 FC 14W	(6) M31-B11-F05-W FC	ACS/WFC, ACCUM, WFC	F814W			Prime + Parallel Group 3-4 in Visit 02	350 Secs [==>]	[1]
	5	M31-B11-F02-UVIS-F3 VIS 36W	(5) M31-B11-F02-U VIS	WFC3/UVIS, ACCUM, UVIS-CENTER	F336W	CR-SPLIT=NO	POS TARG 1.634,4.882	Prime + Parallel Group 5-6 in Visit 02	800 Secs [==>]	[1]
	6	M31-B11-F05-WFC-F8 FC 14W	(6) M31-B11-F05-W FC	ACS/WFC, ACCUM, WFC	F814W			Prime + Parallel Group 5-6 in Visit 02	800 Secs [==>]	[1]
	7	M31-B11-F02-UVIS-F2 VIS 75W	(5) M31-B11-F02-U VIS	WFC3/UVIS, ACCUM, UVIS-CENTER	F275W	CR-SPLIT=NO	POS TARG 1.525,4.882	Prime + Parallel Group 7-8 in Visit 02	660 Secs [==>]	[1]
	8	M31-B11-F05-WFC-F8 FC 14W	(6) M31-B11-F05-W FC	ACS/WFC, ACCUM, WFC	F814W			Prime + Parallel Group 7-8 in Visit 02	550 Secs [==>]	[1]
	9	M31-B11-F02-IR-f160w	(4) M31-B11-F02-IR	WFC3/IR, MULTIACCUM, IR-FIX	F160W	NSAMP=9; SAMP-SEQ=STEP200	POS TARG 0,0	Prime + Parallel Group 9-10 in Visit 02	[==>]	[2]
	10	M31-B11-F05-WFC-F4 FC 75W-short	(6) M31-B11-F05-W FC	ACS/WFC, ACCUM, WFC	F475W			Prime + Parallel Group 9-10 in Visit 02	10 Secs [==>]	[2]
	11	M31-B11-F02-IR-f110w	(4) M31-B11-F02-IR	WFC3/IR, MULTIACCUM, IR-FIX	F110W	NSAMP=11; SAMP-SEQ=STEP200	POS TARG 0.187,0.086	Prime + Parallel Group 11-12 in Visit 02	[==>]	[2]
	12	M31-B11-F05-WFC-F4 FC 75W	(6) M31-B11-F05-W FC	ACS/WFC, ACCUM, WFC	F475W			Prime + Parallel Group 11-12 in Visit 02	700 Secs [==>]	[2]
	13	M31-B11-F02-IR-f160w	(4) M31-B11-F02-IR	WFC3/IR, MULTIACCUM, IR-FIX	F160W	NSAMP=9; SAMP-SEQ=STEP200	POS TARG 0.206,0.171	Prime + Parallel Group 13-14 in Visit 02	[==>]	[2]
	14	M31-B11-F05-WFC-F4 FC 75W	(6) M31-B11-F05-W FC	ACS/WFC, ACCUM, WFC	F475W			Prime + Parallel Group 13-14 in Visit 02	360 Secs [==>]	[2]
	15	M31-B11-F02-IR-f160w	(4) M31-B11-F02-IR	WFC3/IR, MULTIACCUM, IR-FIX	F160W	NSAMP=9; SAMP-SEQ=STEP200	POS TARG 0.263,0.188	Prime + Parallel Group 15-16 in Visit 02	[==>]	[2]
	16	M31-B11-F05-WFC-F4 FC 75W	(6) M31-B11-F05-W FC	ACS/WFC, ACCUM, WFC	F475W			Prime + Parallel Group 15-16 in Visit 02	360 Secs [==>]	[2]
	17	M31-B11-F02-IR-f160w	(4) M31-B11-F02-IR	WFC3/IR, MULTIACCUM, IR-FIX	F160W	NSAMP=11; SAMP-SEQ=STEP100	POS TARG 0.204,-0.001	Prime + Parallel Group 17-18 in Visit 02	[==>]	[2]
	18	M31-B11-F05-WFC-F4 FC 75W	(6) M31-B11-F05-W FC	ACS/WFC, ACCUM, WFC	F475W			Prime + Parallel Group 17-18 in Visit 02	470 Secs [==>]	[2]

Orbit 1

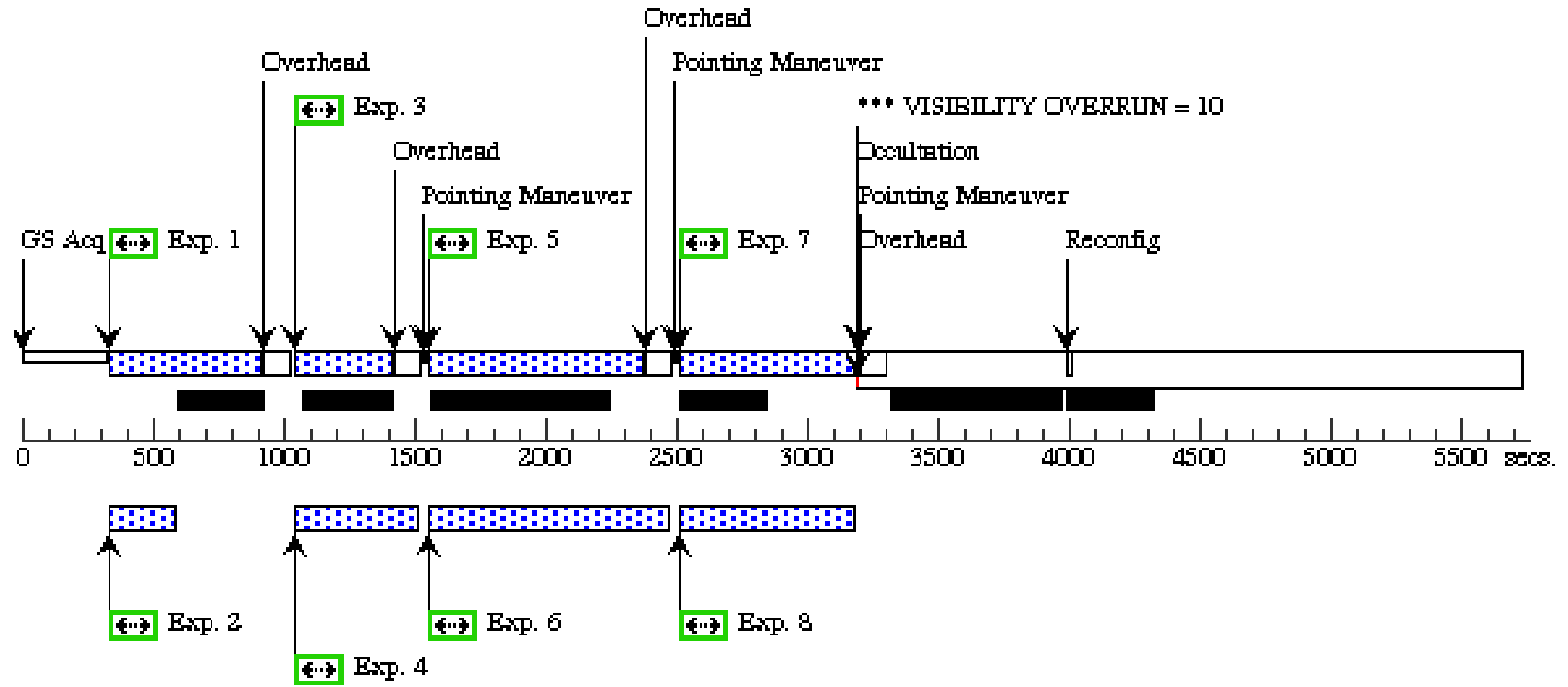

Orbit Structure

Orbit 2

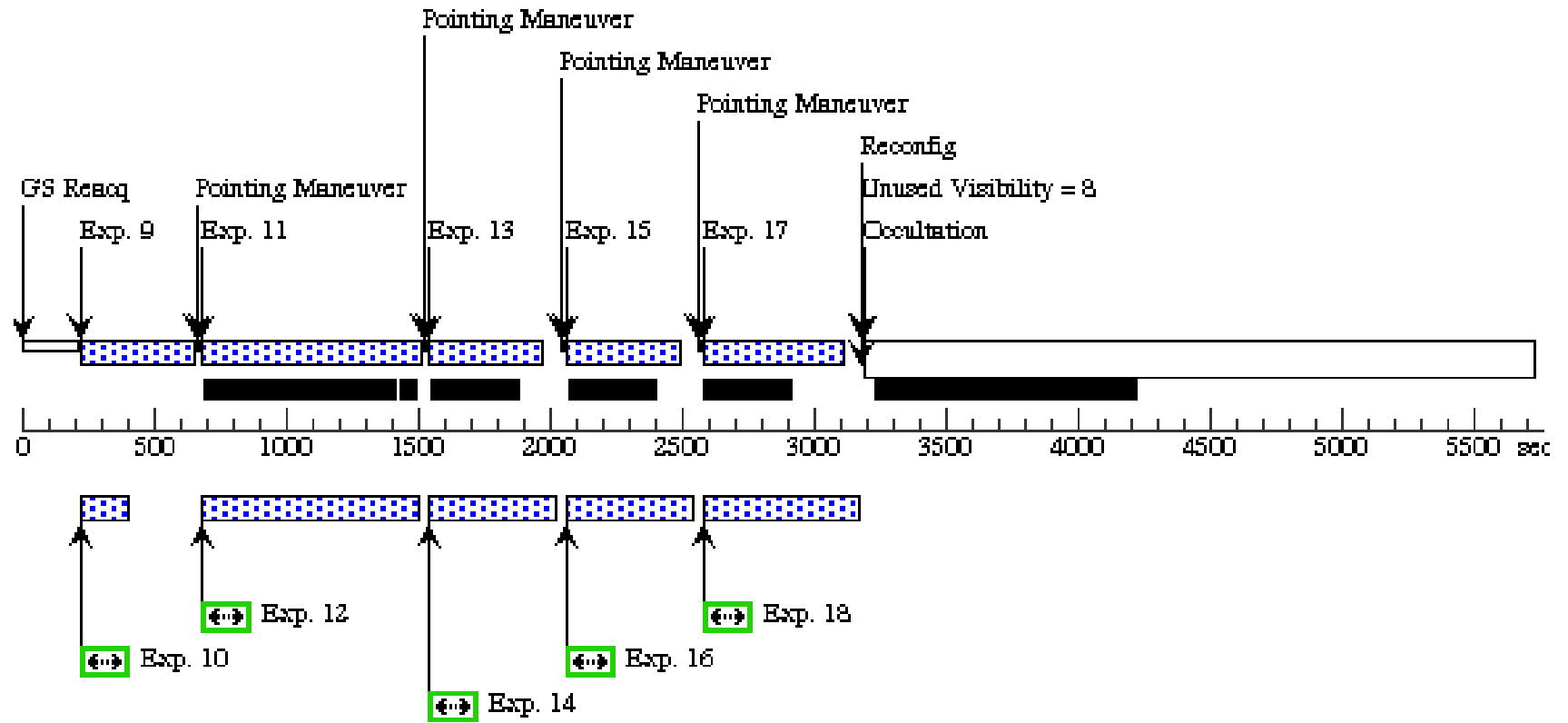

Proposal 12115 - Visit 03 - A Panchromatic Hubble Andromeda Treasury - I

Fri Jun 08 01:09:01 GMT 2012

Visit	Proposal 12115, Visit 03, implementation Diagnostic Status: Warning Scientific Instruments: WFC3/IR, WFC3/UVIS, ACS/WFC Special Requirements: SCHED 60%: ORIENT 54D TO 54 D					
Diagnostics	(Visit 03) Warning (Orbit Planner): PARALLELS SIGNIFICANTLY EXTEND ALIGNMENT TIME (Visit 03) Warning (Form): The 'SCHED=100' special requirement must be selected for this visit. (Visit 03) Warning (Orbit Planner): VISIBILITY OVERRUN					
Fixed Targets	#	Name	Target Coordinates	Targ. Coord. Corrections	Fluxes	Miscellaneous
	(7)	M31-B11-F03-IR	RA: 00 44 41.7390 (11.1739125d) Dec: +41 42 16.25 (41.70451d) Equinox: J2000		V=20+/-0.1	Reference Frame: ICRS
	(8)	M31-B11-F03-UVIS	RA: 00 44 41.7390 (11.1739125d) Dec: +41 42 16.25 (41.70451d) Equinox: J2000		V=20+/-0.1	Reference Frame: ICRS
	(9)	M31-B11-F06-WFC	RA: 00 44 41.7390 (11.1739125d) Dec: +41 42 16.25 (41.70451d) Equinox: J2000		V=20+/-0.1	Reference Frame: ICRS

Proposal 12115 - Visit 03 - A Panchromatic Hubble Andromeda Treasury - I

#	Label	Target	Config,Mode,Aperture	Spectral Els.	Opt. Params.	Special Reqs.	Groups	Exp. Time/[Actual Dur.]	Orbit	
Exposures	1	M31-B11-F03-UVIS-F3 36W	(8) M31-B11-F03-U VIS	WFC3/UVIS, ACCUM, UVIS-CENTER	F336W	CR-SPLIT=NO	POS TARG 1.655,2. 96	Prime + Parallel Gro up 1-2 in Visit 03	550 Secs [==>]	[1]
	2	M31-B11-F06-WFC-F8 14W-short	(9) M31-B11-F06-W FC	ACS/WFC, ACCUM, WFC	F814W			Prime + Parallel Gro up 1-2 in Visit 03	15 Secs [==>]	[1]
	3	M31-B11-F03-UVIS-F2 75W	(8) M31-B11-F03-U VIS	WFC3/UVIS, ACCUM, UVIS-CENTER	F275W	CR-SPLIT=NO	POS TARG 1.655,2. 96	Prime + Parallel Gro up 3-4 in Visit 03	350 Secs [==>]	[1]
	4	M31-B11-F06-WFC-F8 14W	(9) M31-B11-F06-W FC	ACS/WFC, ACCUM, WFC	F814W			Prime + Parallel Gro up 3-4 in Visit 03	350 Secs [==>]	[1]
	5	M31-B11-F03-UVIS-F3 36W	(8) M31-B11-F03-U VIS	WFC3/UVIS, ACCUM, UVIS-CENTER	F336W	CR-SPLIT=NO	POS TARG 1.634,4. 882	Prime + Parallel Gro up 5-6 in Visit 03	800 Secs [==>]	[1]
	6	M31-B11-F06-WFC-F8 14W	(9) M31-B11-F06-W FC	ACS/WFC, ACCUM, WFC	F814W			Prime + Parallel Gro up 5-6 in Visit 03	800 Secs [==>]	[1]
	7	M31-B11-F03-UVIS-F2 75W	(8) M31-B11-F03-U VIS	WFC3/UVIS, ACCUM, UVIS-CENTER	F275W	CR-SPLIT=NO	POS TARG 1.525,4. 882	Prime + Parallel Gro up 7-8 in Visit 03	660 Secs [==>]	[1]
	8	M31-B11-F06-WFC-F8 14W	(9) M31-B11-F06-W FC	ACS/WFC, ACCUM, WFC	F814W			Prime + Parallel Gro up 7-8 in Visit 03	550 Secs [==>]	[1]
	9	M31-B11-F03-IR-f160 w	(7) M31-B11-F03-IR	WFC3/IR, MULTIACCUM, IR-FIX	F160W	NSAMP=9; SAMP-SEQ=STEP2 00	POS TARG 0,0	Prime + Parallel Gro up 9-10 in Visit 03	[==>]	[2]
	10	M31-B11-F06-WFC-F4 75W-short	(9) M31-B11-F06-W FC	ACS/WFC, ACCUM, WFC	F475W			Prime + Parallel Gro up 9-10 in Visit 03	10 Secs [==>]	[2]
	11	M31-B11-F03-IR-f110 w	(7) M31-B11-F03-IR	WFC3/IR, MULTIACCUM, IR-FIX	F110W	NSAMP=11; SAMP-SEQ=STEP2 00	POS TARG 0.187,0. 086	Prime + Parallel Gro up 11-12 in Visit 03	[==>]	[2]
	12	M31-B11-F06-WFC-F4 75W	(9) M31-B11-F06-W FC	ACS/WFC, ACCUM, WFC	F475W			Prime + Parallel Gro up 11-12 in Visit 03	700 Secs [==>]	[2]
	13	M31-B11-F03-IR-f160 w	(7) M31-B11-F03-IR	WFC3/IR, MULTIACCUM, IR-FIX	F160W	NSAMP=9; SAMP-SEQ=STEP2 00	POS TARG 0.206,0. 171	Prime + Parallel Gro up 13-14 in Visit 03	[==>]	[2]
	14	M31-B11-F06-WFC-F4 75W	(9) M31-B11-F06-W FC	ACS/WFC, ACCUM, WFC	F475W			Prime + Parallel Gro up 13-14 in Visit 03	360 Secs [==>]	[2]
	15	M31-B11-F03-IR-f160 w	(7) M31-B11-F03-IR	WFC3/IR, MULTIACCUM, IR-FIX	F160W	NSAMP=9; SAMP-SEQ=STEP2 00	POS TARG 0.263,0. 188	Prime + Parallel Gro up 15-16 in Visit 03	[==>]	[2]
	16	M31-B11-F06-WFC-F4 75W	(9) M31-B11-F06-W FC	ACS/WFC, ACCUM, WFC	F475W			Prime + Parallel Gro up 15-16 in Visit 03	360 Secs [==>]	[2]
	17	M31-B11-F03-IR-f160 w	(7) M31-B11-F03-IR	WFC3/IR, MULTIACCUM, IR-FIX	F160W	NSAMP=11; SAMP-SEQ=STEP1 00	POS TARG 0.204,-0. .001	Prime + Parallel Gro up 17-18 in Visit 03	[==>]	[2]
	18	M31-B11-F06-WFC-F4 75W	(9) M31-B11-F06-W FC	ACS/WFC, ACCUM, WFC	F475W			Prime + Parallel Gro up 17-18 in Visit 03	470 Secs [==>]	[2]

Orbit 1

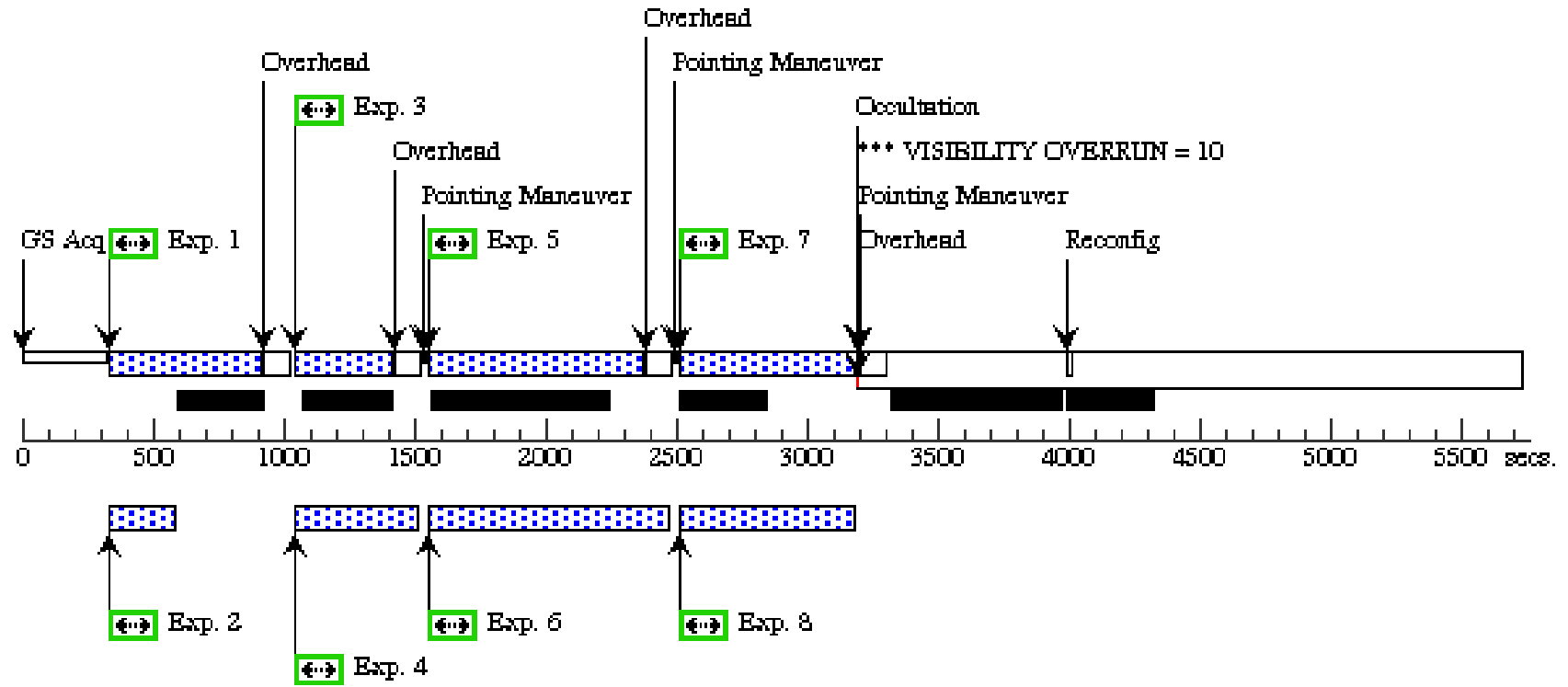

Orbit Structure

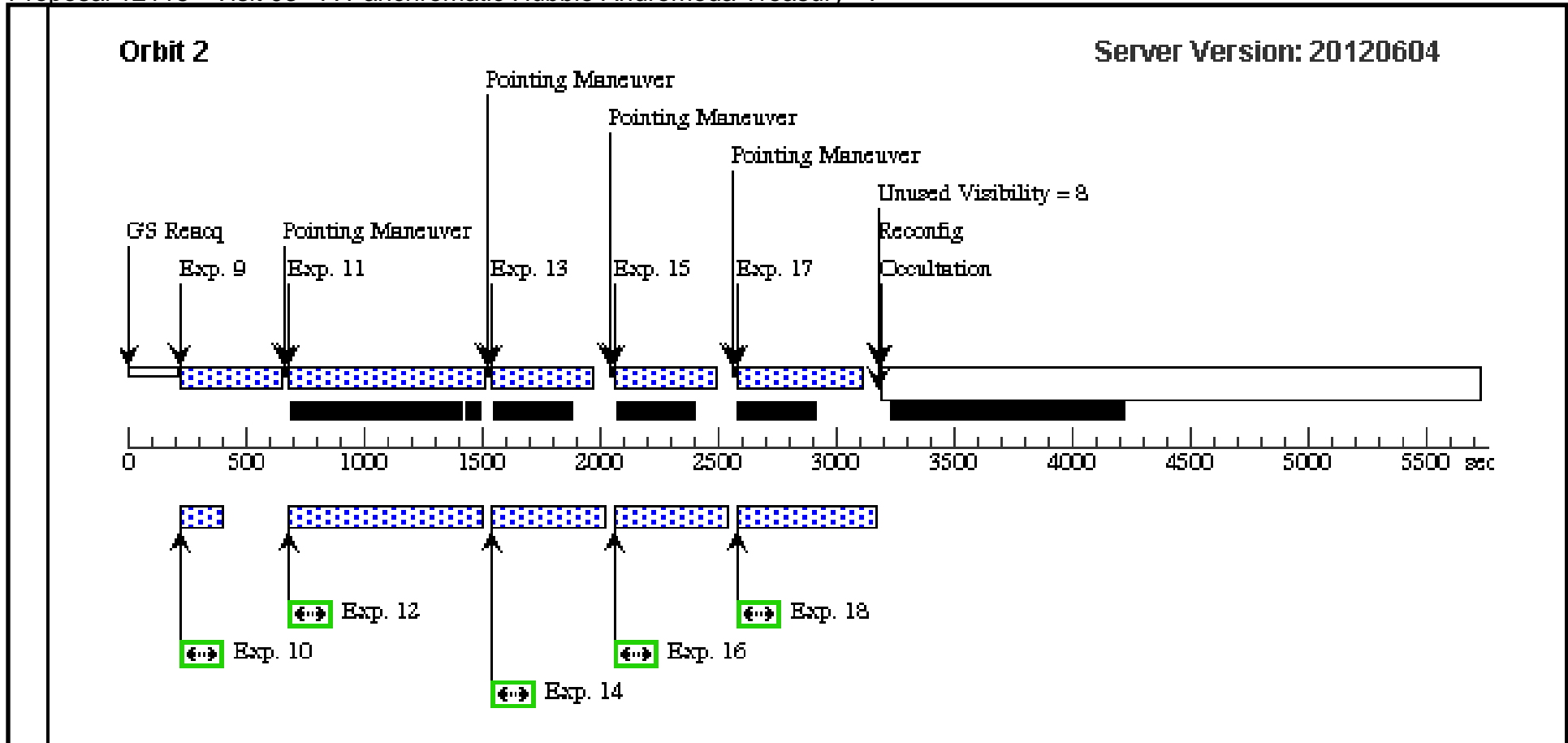

Proposal 12115 - Visit 04 - A Panchromatic Hubble Andromeda Treasury - I

Fri Jun 08 01:09:04 GMT 2012

Visit	Proposal 12115, Visit 04, implementation Diagnostic Status: Warning Scientific Instruments: WFC3/IR, WFC3/UVIS, ACS/WFC Special Requirements: SCHED 100%; ORIENT 234D TO 234 D					
	Diagnosics (Visit 04) Warning (Orbit Planner): PARALLELS SIGNIFICANTLY EXTEND ALIGNMENT TIME (Visit 04) Warning (Orbit Planner): PARALLELS SIGNIFICANTLY EXTEND ALIGNMENT TIME (Visit 04) Warning (Orbit Planner): PARALLELS SIGNIFICANTLY EXTEND ALIGNMENT TIME (Visit 04) Warning (Orbit Planner): VISIBILITY OVERRUN					
Fixed Targets	#	Name	Target Coordinates	Targ. Coord. Corrections	Fluxes	Miscellaneous
	(10)	M31-B11-F04-IR	RA: 00 44 31.0527 (11.1293862d) Dec: +41 42 34.83 (41.70968d) Equinox: J2000		V=20+/-0.1	Reference Frame: ICRS
	(11)	M31-B11-F04-UVIS	RA: 00 44 31.0527 (11.1293862d) Dec: +41 42 34.83 (41.70968d) Equinox: J2000		V=20+/-0.1	Reference Frame: ICRS
	(12)	M31-B11-F01-WFC	RA: 00 44 31.0527 (11.1293862d) Dec: +41 42 34.83 (41.70968d) Equinox: J2000		V=20+/-0.1	Reference Frame: ICRS

Proposal 12115 - Visit 04 - A Panchromatic Hubble Andromeda Treasury - I

#	Label	Target	Config,Mode,Aperture	Spectral Els.	Opt. Params.	Special Reqs.	Groups	Exp. Time/[Actual Dur.]	Orbit	
Exposures	1	M31-B11-F04-UVIS-F3 36W	(11) M31-B11-F04-UVIS	WFC3/UVIS, ACCUM, UVIS-CENTER	F336W	CR-SPLIT=NO	POS TARG 1.655,2.96	Prime + Parallel Group 1-2 in Visit 04	550 Secs [==>]	[1]
	2	M31-B11-F01-WFC-F8 14W-short	(12) M31-B11-F01-WFC	ACS/WFC, ACCUM, WFC	F814W			Prime + Parallel Group 1-2 in Visit 04	15 Secs [==>]	[1]
	3	M31-B11-F04-UVIS-F2 75W	(11) M31-B11-F04-UVIS	WFC3/UVIS, ACCUM, UVIS-CENTER	F275W	CR-SPLIT=NO	POS TARG 1.655,2.96	Prime + Parallel Group 3-4 in Visit 04	350 Secs [==>]	[1]
	4	M31-B11-F01-WFC-F8 14W	(12) M31-B11-F01-WFC	ACS/WFC, ACCUM, WFC	F814W			Prime + Parallel Group 3-4 in Visit 04	350 Secs [==>]	[1]
	5	M31-B11-F04-UVIS-F3 36W	(11) M31-B11-F04-UVIS	WFC3/UVIS, ACCUM, UVIS-CENTER	F336W	CR-SPLIT=NO	POS TARG 1.634,4.882	Prime + Parallel Group 5-6 in Visit 04	700 Secs [==>]	[1]
	6	M31-B11-F01-WFC-F8 14W	(12) M31-B11-F01-WFC	ACS/WFC, ACCUM, WFC	F814W			Prime + Parallel Group 5-6 in Visit 04	700 Secs [==>]	[1]
	7	M31-B11-F04-UVIS-F2 75W	(11) M31-B11-F04-UVIS	WFC3/UVIS, ACCUM, UVIS-CENTER	F275W	CR-SPLIT=NO	POS TARG 1.525,4.882	Prime + Parallel Group 7-8 in Visit 04	575 Secs [==>]	[1]
	8	M31-B11-F01-WFC-F8 14W	(12) M31-B11-F01-WFC	ACS/WFC, ACCUM, WFC	F814W			Prime + Parallel Group 7-8 in Visit 04	455 Secs [==>]	[1]
	9	M31-B11-F04-IR-f160w	(10) M31-B11-F04-IR R	WFC3/IR, MULTIACCUM, IR-FIX	F160W	NSAMP=9; SAMP-SEQ=STEP200	POS TARG 0,0	Prime + Parallel Group 9-10 in Visit 04	[==>]	[2]
	10	M31-B11-F01-WFC-F4 75W-short	(12) M31-B11-F01-WFC	ACS/WFC, ACCUM, WFC	F475W			Prime + Parallel Group 9-10 in Visit 04	10 Secs [==>]	[2]
	11	M31-B11-F04-IR-f110w	(10) M31-B11-F04-IR R	WFC3/IR, MULTIACCUM, IR-FIX	F110W	NSAMP=13; SAMP-SEQ=STEP100	POS TARG 0.187,0.086	Prime + Parallel Group 11-12 in Visit 04	[==>]	[2]
	12	M31-B11-F01-WFC-F4 75W	(12) M31-B11-F01-WFC	ACS/WFC, ACCUM, WFC	F475W			Prime + Parallel Group 11-12 in Visit 04	600 Secs [==>]	[2]
	13	M31-B11-F04-IR-f160w	(10) M31-B11-F04-IR R	WFC3/IR, MULTIACCUM, IR-FIX	F160W	NSAMP=9; SAMP-SEQ=STEP200	POS TARG 0.206,0.171	Prime + Parallel Group 13-14 in Visit 04	[==>]	[2]
	14	M31-B11-F01-WFC-F4 75W	(12) M31-B11-F01-WFC	ACS/WFC, ACCUM, WFC	F475W			Prime + Parallel Group 13-14 in Visit 04	370 Secs [==>]	[2]
	15	M31-B11-F04-IR-f160w	(10) M31-B11-F04-IR R	WFC3/IR, MULTIACCUM, IR-FIX	F160W	NSAMP=9; SAMP-SEQ=STEP200	POS TARG 0.263,0.188	Prime + Parallel Group 15-16 in Visit 04	[==>]	[2]
	16	M31-B11-F01-WFC-F4 75W	(12) M31-B11-F01-WFC	ACS/WFC, ACCUM, WFC	F475W			Prime + Parallel Group 15-16 in Visit 04	370 Secs [==>]	[2]
	17	M31-B11-F04-IR-f160w	(10) M31-B11-F04-IR R	WFC3/IR, MULTIACCUM, IR-FIX	F160W	NSAMP=9; SAMP-SEQ=STEP200	POS TARG 0.204,-0.001	Prime + Parallel Group 17-18 in Visit 04	[==>]	[2]
	18	M31-B11-F01-WFC-F4 75W	(12) M31-B11-F01-WFC	ACS/WFC, ACCUM, WFC	F475W			Prime + Parallel Group 17-18 in Visit 04	370 Secs [==>]	[2]

Orbit 1

Orbit Structure

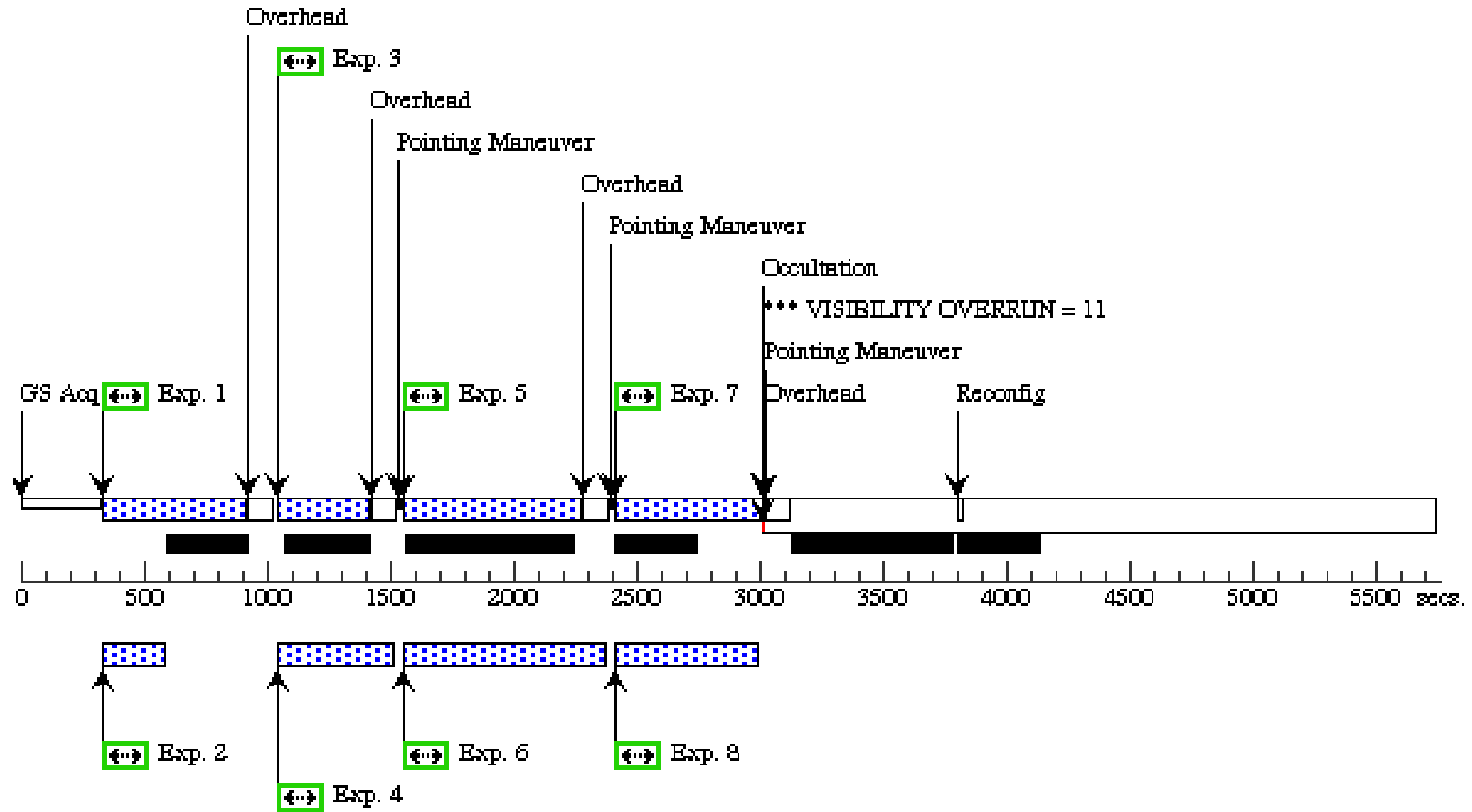

Orbit 2

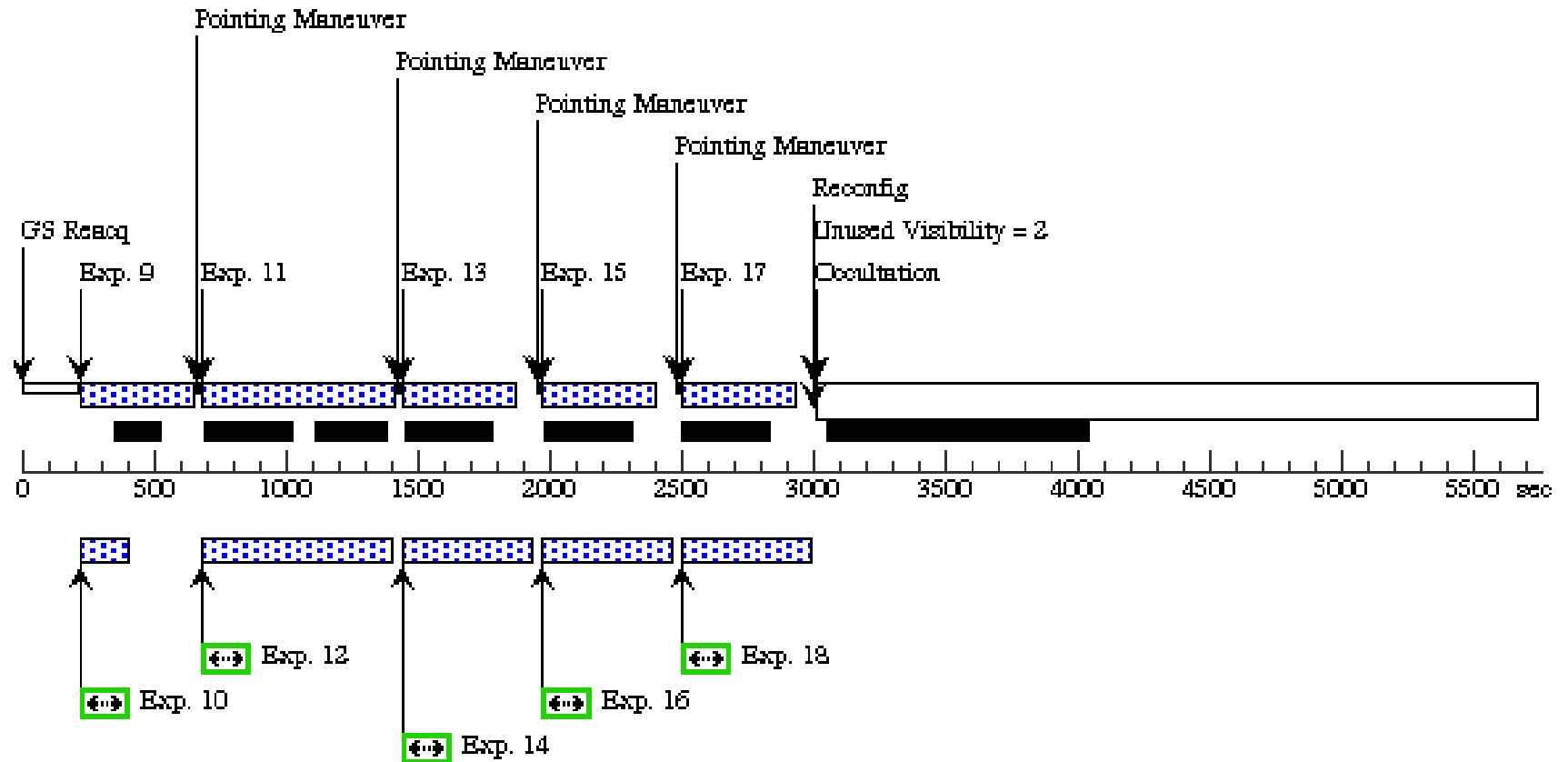

Proposal 12115 - Visit 05 - A Panchromatic Hubble Andromeda Treasury - I

Fri Jun 08 01:09:07 GMT 2012

Visit	Proposal 12115, Visit 05, implementation Diagnostic Status: Warning Scientific Instruments: WFC3/IR, WFC3/UVIS, ACS/WFC Special Requirements: SCHED 100%; ORIENT 234D TO 234 D					
Diagnostics	(Visit 05) Warning (Orbit Planner): PARALLELS SIGNIFICANTLY EXTEND ALIGNMENT TIME (Visit 05) Warning (Orbit Planner): PARALLELS SIGNIFICANTLY EXTEND ALIGNMENT TIME (Visit 05) Warning (Orbit Planner): VISIBILITY OVERRUN (Visit 05) Warning (Orbit Planner): PARALLELS SIGNIFICANTLY EXTEND ALIGNMENT TIME					
Fixed Targets	#	Name	Target Coordinates	Targ. Coord. Corrections	Fluxes	Miscellaneous
	(13)	M31-B11-F05-IR	RA: 00 44 20.5805 (11.0857521d) Dec: +41 42 53.42 (41.71484d) Equinox: J2000		V=20+/-0.1	Reference Frame: ICRS
	(14)	M31-B11-F05-UVIS	RA: 00 44 20.5805 (11.0857521d) Dec: +41 42 53.42 (41.71484d) Equinox: J2000		V=20+/-0.1	Reference Frame: ICRS
	(15)	M31-B11-F02-WFC	RA: 00 44 20.5805 (11.0857521d) Dec: +41 42 53.42 (41.71484d) Equinox: J2000		V=20+/-0.1	Reference Frame: ICRS

Proposal 12115 - Visit 05 - A Panchromatic Hubble Andromeda Treasury - I

Exposures	#	Label	Target	Config,Mode,Aperture	Spectral Els.	Opt. Params.	Special Reqs.	Groups	Exp. Time/[Actual Dur.]	Orbit
	1	M31-B11-F05-UVIS-F336W	(14) M31-B11-F05-UVIS	WFC3/UVIS, ACCUM, UVIS-CENTER	F336W	CR-SPLIT=NO	POS TARG 1.655,2.96	Prime + Parallel Group 1-2 in Visit 05	550 Secs [==>]	[1]
	2	M31-B11-F02-WFC-F814W-short	(15) M31-B11-F02-WFC	ACS/WFC, ACCUM, WFC	F814W			Prime + Parallel Group 1-2 in Visit 05	15 Secs [==>]	[1]
	3	M31-B11-F05-UVIS-F275W	(14) M31-B11-F05-UVIS	WFC3/UVIS, ACCUM, UVIS-CENTER	F275W	CR-SPLIT=NO	POS TARG 1.655,2.96	Prime + Parallel Group 3-4 in Visit 05	350 Secs [==>]	[1]
	4	M31-B11-F02-WFC-F814W	(15) M31-B11-F02-WFC	ACS/WFC, ACCUM, WFC	F814W			Prime + Parallel Group 3-4 in Visit 05	350 Secs [==>]	[1]
	5	M31-B11-F05-UVIS-F336W	(14) M31-B11-F05-UVIS	WFC3/UVIS, ACCUM, UVIS-CENTER	F336W	CR-SPLIT=NO	POS TARG 1.634,4.882	Prime + Parallel Group 5-6 in Visit 05	700 Secs [==>]	[1]
	6	M31-B11-F02-WFC-F814W	(15) M31-B11-F02-WFC	ACS/WFC, ACCUM, WFC	F814W			Prime + Parallel Group 5-6 in Visit 05	700 Secs [==>]	[1]
	7	M31-B11-F05-UVIS-F275W	(14) M31-B11-F05-UVIS	WFC3/UVIS, ACCUM, UVIS-CENTER	F275W	CR-SPLIT=NO	POS TARG 1.525,4.882	Prime + Parallel Group 7-8 in Visit 05	575 Secs [==>]	[1]
	8	M31-B11-F02-WFC-F814W	(15) M31-B11-F02-WFC	ACS/WFC, ACCUM, WFC	F814W			Prime + Parallel Group 7-8 in Visit 05	455 Secs [==>]	[1]
	9	M31-B11-F05-IR-f160w	(13) M31-B11-F05-IR	WFC3/IR, MULTIACCUM, IR-FIX	F160W	NSAMP=9; SAMP-SEQ=STEP200	POS TARG 0,0	Prime + Parallel Group 9-10 in Visit 05	[==>]	[2]
	10	M31-B11-F02-WFC-F475W-short	(15) M31-B11-F02-WFC	ACS/WFC, ACCUM, WFC	F475W			Prime + Parallel Group 9-10 in Visit 05	10 Secs [==>]	[2]
	11	M31-B11-F05-IR-f110w	(13) M31-B11-F05-IR	WFC3/IR, MULTIACCUM, IR-FIX	F110W	NSAMP=13; SAMP-SEQ=STEP100	POS TARG 0.187,0.086	Prime + Parallel Group 11-12 in Visit 05	[==>]	[2]
	12	M31-B11-F02-WFC-F475W	(15) M31-B11-F02-WFC	ACS/WFC, ACCUM, WFC	F475W			Prime + Parallel Group 11-12 in Visit 05	600 Secs [==>]	[2]
	13	M31-B11-F05-IR-f160w	(13) M31-B11-F05-IR	WFC3/IR, MULTIACCUM, IR-FIX	F160W	NSAMP=9; SAMP-SEQ=STEP200	POS TARG 0.206,0.171	Prime + Parallel Group 13-14 in Visit 05	[==>]	[2]
	14	M31-B11-F02-WFC-F475W	(15) M31-B11-F02-WFC	ACS/WFC, ACCUM, WFC	F475W			Prime + Parallel Group 13-14 in Visit 05	370 Secs [==>]	[2]
	15	M31-B11-F05-IR-f160w	(13) M31-B11-F05-IR	WFC3/IR, MULTIACCUM, IR-FIX	F160W	NSAMP=9; SAMP-SEQ=STEP200	POS TARG 0.263,0.188	Prime + Parallel Group 15-16 in Visit 05	[==>]	[2]
	16	M31-B11-F02-WFC-F475W	(15) M31-B11-F02-WFC	ACS/WFC, ACCUM, WFC	F475W			Prime + Parallel Group 15-16 in Visit 05	370 Secs [==>]	[2]
	17	M31-B11-F05-IR-f160w	(13) M31-B11-F05-IR	WFC3/IR, MULTIACCUM, IR-FIX	F160W	NSAMP=9; SAMP-SEQ=STEP200	POS TARG 0.204,-0.001	Prime + Parallel Group 17-18 in Visit 05	[==>]	[2]
18	M31-B11-F02-WFC-F475W	(15) M31-B11-F02-WFC	ACS/WFC, ACCUM, WFC	F475W			Prime + Parallel Group 17-18 in Visit 05	370 Secs [==>]	[2]	

Orbit 2

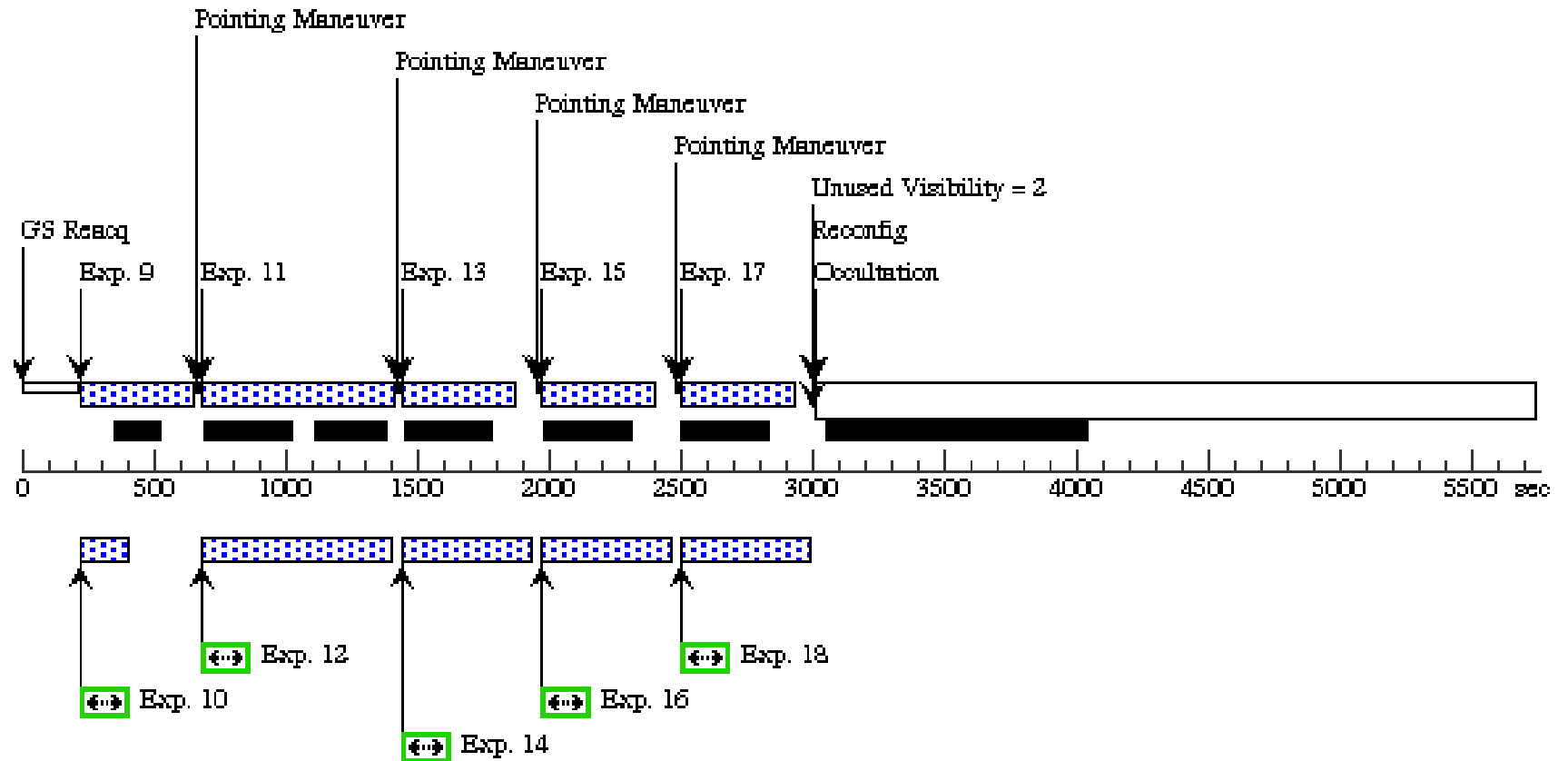

Proposal 12115 - Visit 06 - A Panchromatic Hubble Andromeda Treasury - I

Fri Jun 08 01:09:10 GMT 2012

Visit	Proposal 12115, Visit 06, implementation Diagnostic Status: Warning Scientific Instruments: WFC3/IR, WFC3/UVIS, ACS/WFC Special Requirements: SCHED 100%; ORIENT 234D TO 234 D					
Diagnostics	(Visit 06) Warning (Orbit Planner): PARALLELS SIGNIFICANTLY EXTEND ALIGNMENT TIME (Visit 06) Warning (Orbit Planner): PARALLELS SIGNIFICANTLY EXTEND ALIGNMENT TIME (Visit 06) Warning (Orbit Planner): VISIBILITY OVERRUN (Visit 06) Warning (Orbit Planner): PARALLELS SIGNIFICANTLY EXTEND ALIGNMENT TIME					
Fixed Targets	#	Name	Target Coordinates	Targ. Coord. Corrections	Fluxes	Miscellaneous
	(16)	M31-B11-F06-IR	RA: 00 44 10.1084 (11.0421183d) Dec: +41 43 12.00 (41.72000d) Equinox: J2000		V=20+/-0.1	Reference Frame: ICRS
	(17)	M31-B11-F06-UVIS	RA: 00 44 10.1084 (11.0421183d) Dec: +41 43 12.00 (41.72000d) Equinox: J2000		V=20+/-0.1	Reference Frame: ICRS
	(18)	M31-B11-F03-WFC	RA: 00 44 10.1084 (11.0421183d) Dec: +41 43 12.00 (41.72000d) Equinox: J2000		V=20+/-0.1	Reference Frame: ICRS

Proposal 12115 - Visit 06 - A Panchromatic Hubble Andromeda Treasury - I

#	Label	Target	Config,Mode,Aperture	Spectral Els.	Opt. Params.	Special Reqs.	Groups	Exp. Time/[Actual Dur.]	Orbit	
Exposures	1	M31-B11-F06-UVIS-F3 36W	(17) M31-B11-F06-UVIS	WFC3/UVIS, ACCUM, UVIS-CENTER	F336W	CR-SPLIT=NO	POS TARG 1.655,2.96	Prime + Parallel Group 1-2 in Visit 06	550 Secs [==>]	[1]
	2	M31-B11-F03-WFC-F8 14W-short	(18) M31-B11-F03-WFC	ACS/WFC, ACCUM, WFC	F814W			Prime + Parallel Group 1-2 in Visit 06	15 Secs [==>]	[1]
	3	M31-B11-F06-UVIS-F2 75W	(17) M31-B11-F06-UVIS	WFC3/UVIS, ACCUM, UVIS-CENTER	F275W	CR-SPLIT=NO	POS TARG 1.655,2.96	Prime + Parallel Group 3-4 in Visit 06	350 Secs [==>]	[1]
	4	M31-B11-F03-WFC-F8 14W	(18) M31-B11-F03-WFC	ACS/WFC, ACCUM, WFC	F814W			Prime + Parallel Group 3-4 in Visit 06	350 Secs [==>]	[1]
	5	M31-B11-F06-UVIS-F3 36W	(17) M31-B11-F06-UVIS	WFC3/UVIS, ACCUM, UVIS-CENTER	F336W	CR-SPLIT=NO	POS TARG 1.634,4.882	Prime + Parallel Group 5-6 in Visit 06	700 Secs [==>]	[1]
	6	M31-B11-F03-WFC-F8 14W	(18) M31-B11-F03-WFC	ACS/WFC, ACCUM, WFC	F814W			Prime + Parallel Group 5-6 in Visit 06	700 Secs [==>]	[1]
	7	M31-B11-F06-UVIS-F2 75W	(17) M31-B11-F06-UVIS	WFC3/UVIS, ACCUM, UVIS-CENTER	F275W	CR-SPLIT=NO	POS TARG 1.525,4.882	Prime + Parallel Group 7-8 in Visit 06	575 Secs [==>]	[1]
	8	M31-B11-F03-WFC-F8 14W	(18) M31-B11-F03-WFC	ACS/WFC, ACCUM, WFC	F814W			Prime + Parallel Group 7-8 in Visit 06	455 Secs [==>]	[1]
	9	M31-B11-F06-IR-f160w	(16) M31-B11-F06-IR	WFC3/IR, MULTIACCUM, IR-FIX	F160W	NSAMP=9; SAMP-SEQ=STEP200	POS TARG 0,0	Prime + Parallel Group 9-10 in Visit 06	[==>]	[2]
	10	M31-B11-F03-WFC-F4 75W-short	(18) M31-B11-F03-WFC	ACS/WFC, ACCUM, WFC	F475W			Prime + Parallel Group 9-10 in Visit 06	10 Secs [==>]	[2]
	11	M31-B11-F06-IR-f110w	(16) M31-B11-F06-IR	WFC3/IR, MULTIACCUM, IR-FIX	F110W	NSAMP=13; SAMP-SEQ=STEP100	POS TARG 0.187,0.086	Prime + Parallel Group 11-12 in Visit 06	[==>]	[2]
	12	M31-B11-F03-WFC-F4 75W	(18) M31-B11-F03-WFC	ACS/WFC, ACCUM, WFC	F475W			Prime + Parallel Group 11-12 in Visit 06	600 Secs [==>]	[2]
	13	M31-B11-F06-IR-f160w	(16) M31-B11-F06-IR	WFC3/IR, MULTIACCUM, IR-FIX	F160W	NSAMP=9; SAMP-SEQ=STEP200	POS TARG 0.206,0.171	Prime + Parallel Group 13-14 in Visit 06	[==>]	[2]
	14	M31-B11-F03-WFC-F4 75W	(18) M31-B11-F03-WFC	ACS/WFC, ACCUM, WFC	F475W			Prime + Parallel Group 13-14 in Visit 06	370 Secs [==>]	[2]
	15	M31-B11-F06-IR-f160w	(16) M31-B11-F06-IR	WFC3/IR, MULTIACCUM, IR-FIX	F160W	NSAMP=9; SAMP-SEQ=STEP200	POS TARG 0.263,0.188	Prime + Parallel Group 15-16 in Visit 06	[==>]	[2]
	16	M31-B11-F03-WFC-F4 75W	(18) M31-B11-F03-WFC	ACS/WFC, ACCUM, WFC	F475W			Prime + Parallel Group 15-16 in Visit 06	370 Secs [==>]	[2]
	17	M31-B11-F06-IR-f160w	(16) M31-B11-F06-IR	WFC3/IR, MULTIACCUM, IR-FIX	F160W	NSAMP=9; SAMP-SEQ=STEP200	POS TARG 0.204,-0.001	Prime + Parallel Group 17-18 in Visit 06	[==>]	[2]
	18	M31-B11-F03-WFC-F4 75W	(18) M31-B11-F03-WFC	ACS/WFC, ACCUM, WFC	F475W			Prime + Parallel Group 17-18 in Visit 06	370 Secs [==>]	[2]

Orbit 1

Orbit Structure

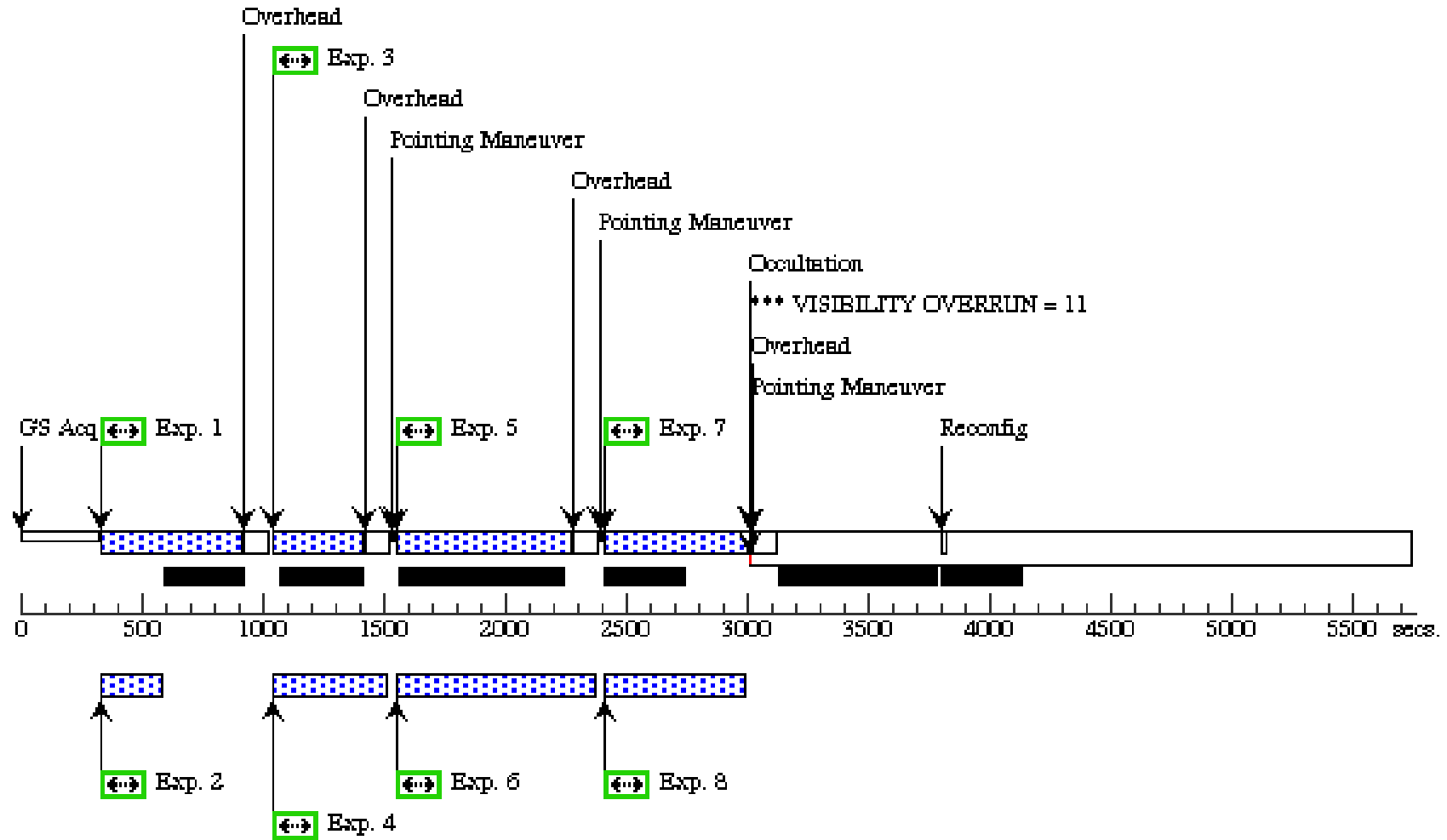

Orbit 2

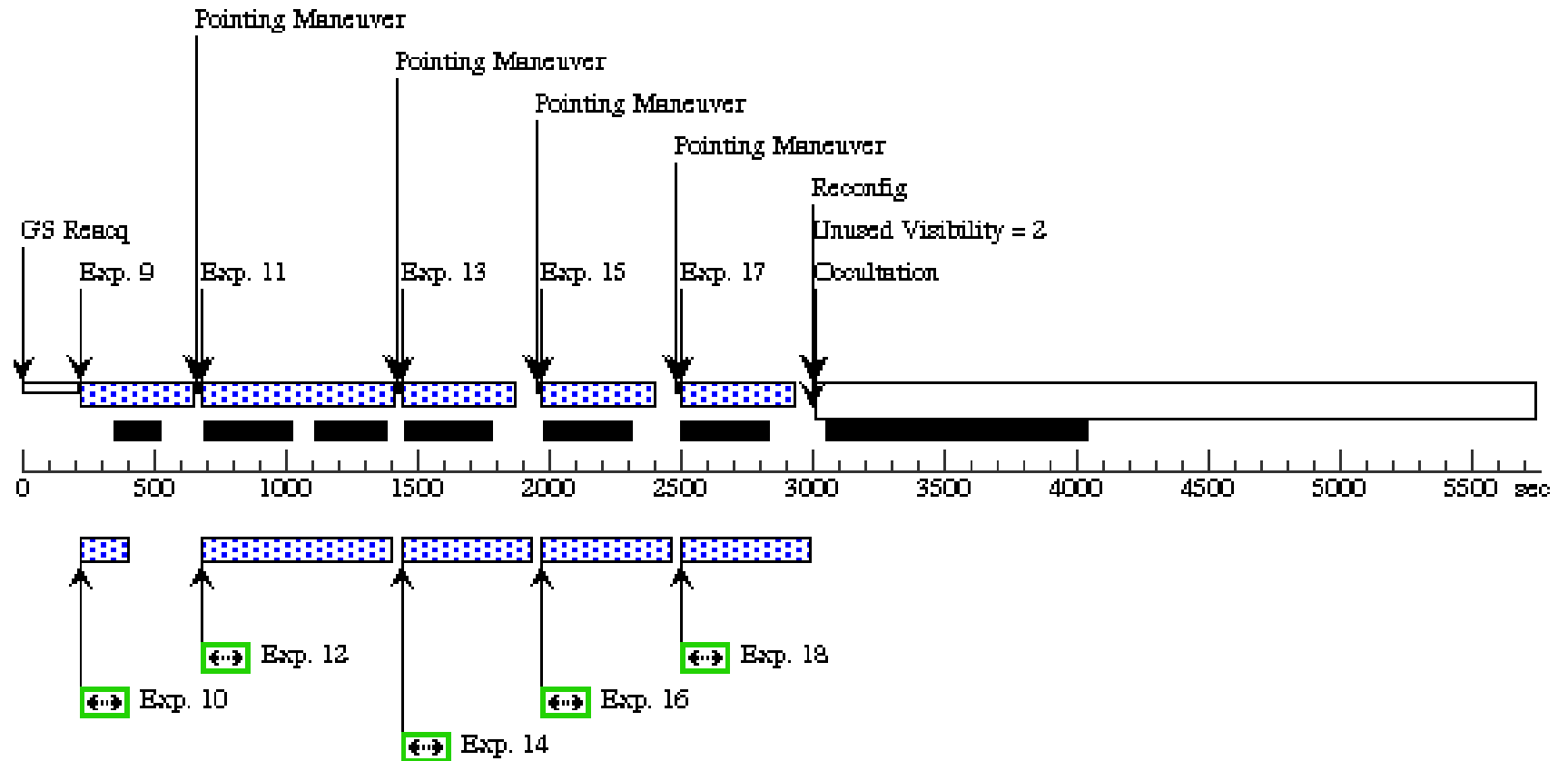

Proposal 12115 - Visit 07 - A Panchromatic Hubble Andromeda Treasury - I

Fri Jun 08 01:09:13 GMT 2012

Visit	Proposal 12115, Visit 07, implementation Diagnostic Status: Warning Scientific Instruments: WFC3/IR, WFC3/UVIS, ACS/WFC Special Requirements: SCHED 60%: ORIENT 54D TO 54 D					
	(Visit 07) Warning (Form): The 'SCHED=100' special requirement must be selected for this visit. (Visit 07) Warning (Orbit Planner): PARALLELS SIGNIFICANTLY EXTEND ALIGNMENT TIME (Visit 07) Warning (Orbit Planner): VISIBILITY OVERRUN					
Fixed Targets	#	Name	Target Coordinates	Targ. Coord. Corrections	Fluxes	Miscellaneous
	(19)	M31-B11-F07-IR	RA: 00 45 0.8152 (11.2533967d) Dec: +41 39 26.93 (41.65748d) Equinox: J2000		V=20+/-0.1	Reference Frame: ICRS
	(20)	M31-B11-F07-UVIS	RA: 00 45 0.8152 (11.2533967d) Dec: +41 39 26.93 (41.65748d) Equinox: J2000		V=20+/-0.1	Reference Frame: ICRS
	(21)	M31-B11-F10-WFC	RA: 00 45 0.8152 (11.2533967d) Dec: +41 39 26.93 (41.65748d) Equinox: J2000		V=20+/-0.1	Reference Frame: ICRS

Proposal 12115 - Visit 07 - A Panchromatic Hubble Andromeda Treasury - I

Exposures	#	Label	Target	Config,Mode,Aperture	Spectral Els.	Opt. Params.	Special Reqs.	Groups	Exp. Time/[Actual Dur.]	Orbit
	1	M31-B11-F07-UVIS-F3 36W	(20) M31-B11-F07-UVIS	WFC3/UVIS, ACCUM, UVIS-CENTER	F336W	CR-SPLIT=NO	POS TARG 1.655,2.96	Prime + Parallel Group 1-2 in Visit 07	550 Secs [==>]	[1]
	2	M31-B11-F10-WFC-F8 14W-short	(21) M31-B11-F10-WFC	ACS/WFC, ACCUM, WFC	F814W			Prime + Parallel Group 1-2 in Visit 07	15 Secs [==>]	[1]
	3	M31-B11-F07-UVIS-F2 75W	(20) M31-B11-F07-UVIS	WFC3/UVIS, ACCUM, UVIS-CENTER	F275W	CR-SPLIT=NO	POS TARG 1.655,2.96	Prime + Parallel Group 3-4 in Visit 07	350 Secs [==>]	[1]
	4	M31-B11-F10-WFC-F8 14W	(21) M31-B11-F10-WFC	ACS/WFC, ACCUM, WFC	F814W			Prime + Parallel Group 3-4 in Visit 07	350 Secs [==>]	[1]
	5	M31-B11-F07-UVIS-F3 36W	(20) M31-B11-F07-UVIS	WFC3/UVIS, ACCUM, UVIS-CENTER	F336W	CR-SPLIT=NO	POS TARG 1.634,4.882	Prime + Parallel Group 5-6 in Visit 07	800 Secs [==>]	[1]
	6	M31-B11-F10-WFC-F8 14W	(21) M31-B11-F10-WFC	ACS/WFC, ACCUM, WFC	F814W			Prime + Parallel Group 5-6 in Visit 07	800 Secs [==>]	[1]
	7	M31-B11-F07-UVIS-F2 75W	(20) M31-B11-F07-UVIS	WFC3/UVIS, ACCUM, UVIS-CENTER	F275W	CR-SPLIT=NO	POS TARG 1.525,4.882	Prime + Parallel Group 7-8 in Visit 07	660 Secs [==>]	[1]
	8	M31-B11-F10-WFC-F8 14W	(21) M31-B11-F10-WFC	ACS/WFC, ACCUM, WFC	F814W			Prime + Parallel Group 7-8 in Visit 07	550 Secs [==>]	[1]
	9	M31-B11-F07-IR-f160w	(19) M31-B11-F07-IR	WFC3/IR, MULTIACCUM, IR-FIX	F160W	NSAMP=9; SAMP-SEQ=STEP200	POS TARG 0,0	Prime + Parallel Group 9-10 in Visit 07	[==>]	[2]
	10	M31-B11-F10-WFC-F4 75W-short	(21) M31-B11-F10-WFC	ACS/WFC, ACCUM, WFC	F475W			Prime + Parallel Group 9-10 in Visit 07	10 Secs [==>]	[2]
	11	M31-B11-F07-IR-f110w	(19) M31-B11-F07-IR	WFC3/IR, MULTIACCUM, IR-FIX	F110W	NSAMP=11; SAMP-SEQ=STEP200	POS TARG 0.187,0.086	Prime + Parallel Group 11-12 in Visit 07	[==>]	[2]
	12	M31-B11-F10-WFC-F4 75W	(21) M31-B11-F10-WFC	ACS/WFC, ACCUM, WFC	F475W			Prime + Parallel Group 11-12 in Visit 07	700 Secs [==>]	[2]
	13	M31-B11-F07-IR-f160w	(19) M31-B11-F07-IR	WFC3/IR, MULTIACCUM, IR-FIX	F160W	NSAMP=9; SAMP-SEQ=STEP200	POS TARG 0.206,0.171	Prime + Parallel Group 13-14 in Visit 07	[==>]	[2]
	14	M31-B11-F10-WFC-F4 75W	(21) M31-B11-F10-WFC	ACS/WFC, ACCUM, WFC	F475W			Prime + Parallel Group 13-14 in Visit 07	360 Secs [==>]	[2]
	15	M31-B11-F07-IR-f160w	(19) M31-B11-F07-IR	WFC3/IR, MULTIACCUM, IR-FIX	F160W	NSAMP=9; SAMP-SEQ=STEP200	POS TARG 0.263,0.188	Prime + Parallel Group 15-16 in Visit 07	[==>]	[2]
	16	M31-B11-F10-WFC-F4 75W	(21) M31-B11-F10-WFC	ACS/WFC, ACCUM, WFC	F475W			Prime + Parallel Group 15-16 in Visit 07	360 Secs [==>]	[2]
	17	M31-B11-F07-IR-f160w	(19) M31-B11-F07-IR	WFC3/IR, MULTIACCUM, IR-FIX	F160W	NSAMP=11; SAMP-SEQ=STEP100	POS TARG 0.204,-0.001	Prime + Parallel Group 17-18 in Visit 07	[==>]	[2]
18	M31-B11-F10-WFC-F4 75W	(21) M31-B11-F10-WFC	ACS/WFC, ACCUM, WFC	F475W			Prime + Parallel Group 17-18 in Visit 07	470 Secs [==>]	[2]	

Orbit 1

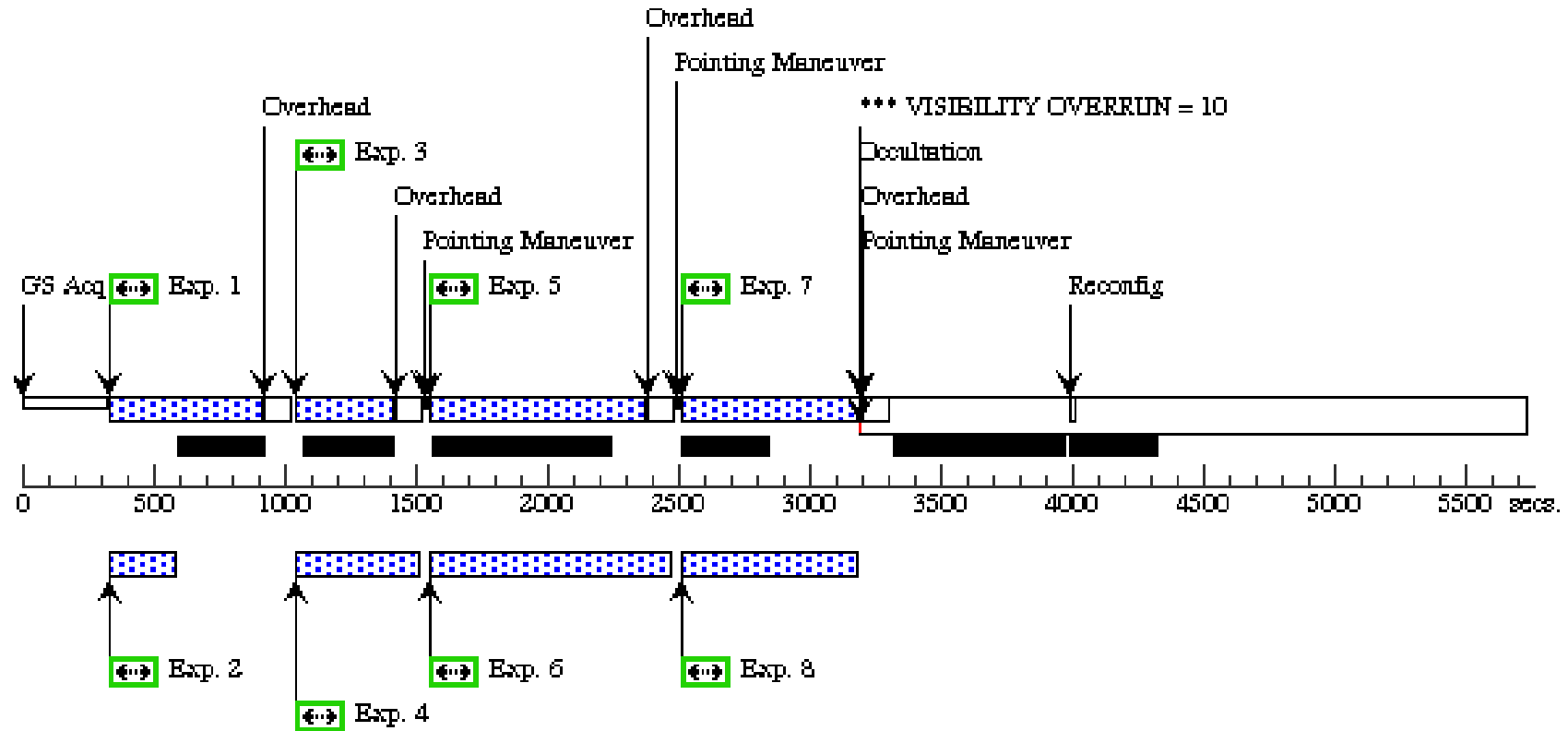

Orbit Structure

Orbit 2

Server Version: 20120604

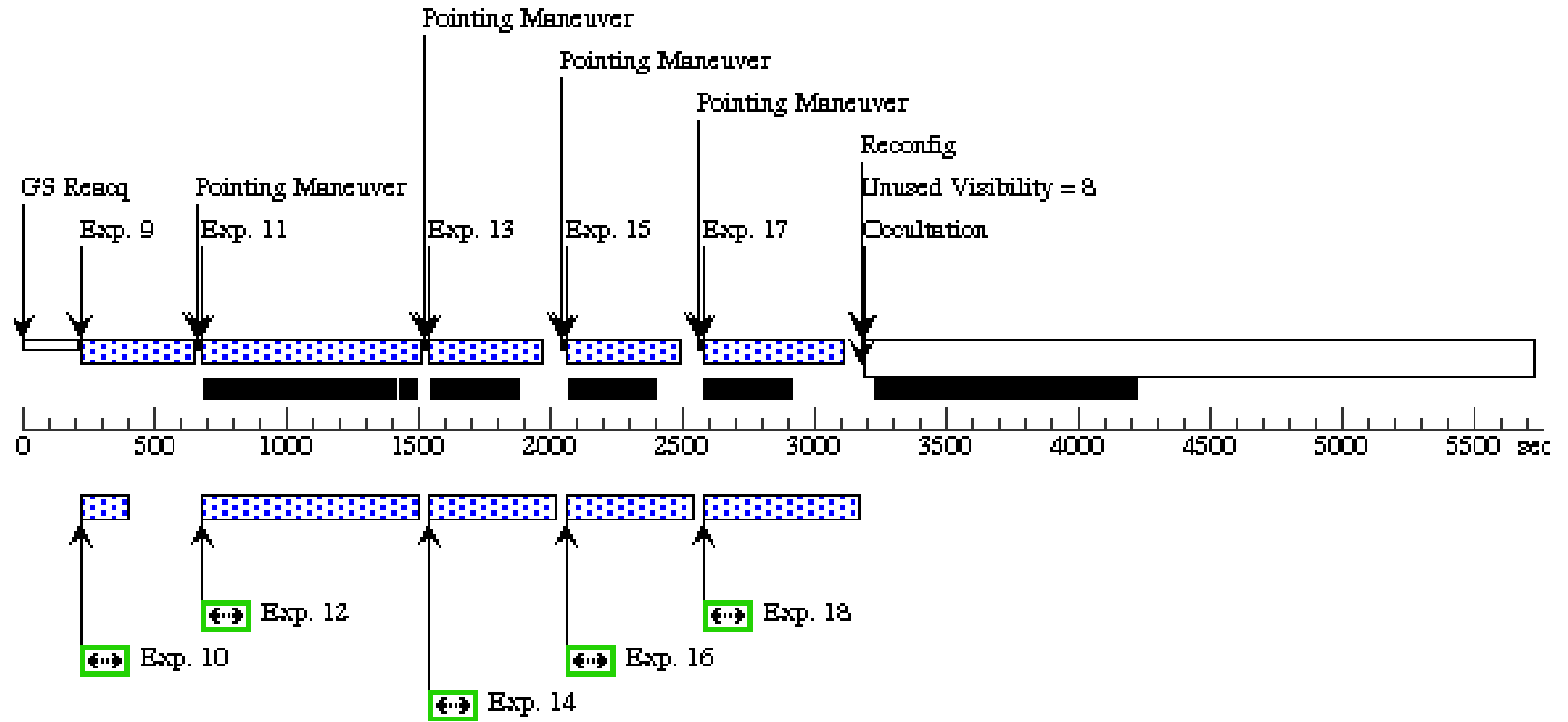

Proposal 12115 - Visit 08 - A Panchromatic Hubble Andromeda Treasury - I

Fri Jun 08 01:09:16 GMT 2012

Visit	Proposal 12115, Visit 08, implementation Diagnostic Status: Warning Scientific Instruments: WFC3/IR, WFC3/UVIS, ACS/WFC Special Requirements: SCHED 60%: ORIENT 54D TO 54 D					
Diagnostics	(Visit 08) Warning (Orbit Planner): PARALLELS SIGNIFICANTLY EXTEND ALIGNMENT TIME (Visit 08) Warning (Form): The 'SCHED=100' special requirement must be selected for this visit. (Visit 08) Warning (Orbit Planner): VISIBILITY OVERRUN					
Fixed Targets	#	Name	Target Coordinates	Targ. Coord. Corrections	Fluxes	Miscellaneous
	(22)	M31-B11-F08-IR	RA: 00 44 50.3431 (11.2097629d) Dec: +41 39 45.51 (41.66264d) Equinox: J2000		V=20+/-0.1	Reference Frame: ICRS
	(23)	M31-B11-F08-UVIS	RA: 00 44 50.3431 (11.2097629d) Dec: +41 39 45.51 (41.66264d) Equinox: J2000		V=20+/-0.1	Reference Frame: ICRS
	(24)	M31-B11-F11-WFC	RA: 00 44 50.3431 (11.2097629d) Dec: +41 39 45.51 (41.66264d) Equinox: J2000		V=20+/-0.1	Reference Frame: ICRS

Proposal 12115 - Visit 08 - A Panchromatic Hubble Andromeda Treasury - I

#	Label	Target	Config,Mode,Aperture	Spectral Els.	Opt. Params.	Special Reqs.	Groups	Exp. Time/[Actual Dur.]	Orbit	
Exposures	1	M31-B11-F08-UVIS-F3 36W	(23) M31-B11-F08-UVIS	WFC3/UVIS, ACCUM, UVIS-CENTER	F336W	CR-SPLIT=NO	POS TARG 1.655,2.96	Prime + Parallel Group 1-2 in Visit 08	550 Secs [==>]	[1]
	2	M31-B11-F11-WFC-F8 14W-short	(24) M31-B11-F11-WFC	ACS/WFC, ACCUM, WFC	F814W			Prime + Parallel Group 1-2 in Visit 08	15 Secs [==>]	[1]
	3	M31-B11-F08-UVIS-F2 75W	(23) M31-B11-F08-UVIS	WFC3/UVIS, ACCUM, UVIS-CENTER	F275W	CR-SPLIT=NO	POS TARG 1.655,2.96	Prime + Parallel Group 3-4 in Visit 08	350 Secs [==>]	[1]
	4	M31-B11-F11-WFC-F8 14W	(24) M31-B11-F11-WFC	ACS/WFC, ACCUM, WFC	F814W			Prime + Parallel Group 3-4 in Visit 08	350 Secs [==>]	[1]
	5	M31-B11-F08-UVIS-F3 36W	(23) M31-B11-F08-UVIS	WFC3/UVIS, ACCUM, UVIS-CENTER	F336W	CR-SPLIT=NO	POS TARG 1.634,4.882	Prime + Parallel Group 5-6 in Visit 08	800 Secs [==>]	[1]
	6	M31-B11-F11-WFC-F8 14W	(24) M31-B11-F11-WFC	ACS/WFC, ACCUM, WFC	F814W			Prime + Parallel Group 5-6 in Visit 08	800 Secs [==>]	[1]
	7	M31-B11-F08-UVIS-F2 75W	(23) M31-B11-F08-UVIS	WFC3/UVIS, ACCUM, UVIS-CENTER	F275W	CR-SPLIT=NO	POS TARG 1.525,4.882	Prime + Parallel Group 7-8 in Visit 08	660 Secs [==>]	[1]
	8	M31-B11-F11-WFC-F8 14W	(24) M31-B11-F11-WFC	ACS/WFC, ACCUM, WFC	F814W			Prime + Parallel Group 7-8 in Visit 08	550 Secs [==>]	[1]
	9	M31-B11-F08-IR-f160w	(22) M31-B11-F08-IR	WFC3/IR, MULTIACCUM, IR-FIX	F160W	NSAMP=9; SAMP-SEQ=STEP200	POS TARG 0,0	Prime + Parallel Group 9-10 in Visit 08	[==>]	[2]
	10	M31-B11-F11-WFC-F4 75W-short	(24) M31-B11-F11-WFC	ACS/WFC, ACCUM, WFC	F475W			Prime + Parallel Group 9-10 in Visit 08	10 Secs [==>]	[2]
	11	M31-B11-F08-IR-f110w	(22) M31-B11-F08-IR	WFC3/IR, MULTIACCUM, IR-FIX	F110W	NSAMP=11; SAMP-SEQ=STEP200	POS TARG 0.187,0.086	Prime + Parallel Group 11-12 in Visit 08	[==>]	[2]
	12	M31-B11-F11-WFC-F4 75W	(24) M31-B11-F11-WFC	ACS/WFC, ACCUM, WFC	F475W			Prime + Parallel Group 11-12 in Visit 08	700 Secs [==>]	[2]
	13	M31-B11-F08-IR-f160w	(22) M31-B11-F08-IR	WFC3/IR, MULTIACCUM, IR-FIX	F160W	NSAMP=9; SAMP-SEQ=STEP200	POS TARG 0.206,0.171	Prime + Parallel Group 13-14 in Visit 08	[==>]	[2]
	14	M31-B11-F11-WFC-F4 75W	(24) M31-B11-F11-WFC	ACS/WFC, ACCUM, WFC	F475W			Prime + Parallel Group 13-14 in Visit 08	360 Secs [==>]	[2]
	15	M31-B11-F08-IR-f160w	(22) M31-B11-F08-IR	WFC3/IR, MULTIACCUM, IR-FIX	F160W	NSAMP=9; SAMP-SEQ=STEP200	POS TARG 0.263,0.188	Prime + Parallel Group 15-16 in Visit 08	[==>]	[2]
	16	M31-B11-F11-WFC-F4 75W	(24) M31-B11-F11-WFC	ACS/WFC, ACCUM, WFC	F475W			Prime + Parallel Group 15-16 in Visit 08	360 Secs [==>]	[2]
	17	M31-B11-F08-IR-f160w	(22) M31-B11-F08-IR	WFC3/IR, MULTIACCUM, IR-FIX	F160W	NSAMP=11; SAMP-SEQ=STEP100	POS TARG 0.204,-0.001	Prime + Parallel Group 17-18 in Visit 08	[==>]	[2]
	18	M31-B11-F11-WFC-F4 75W	(24) M31-B11-F11-WFC	ACS/WFC, ACCUM, WFC	F475W			Prime + Parallel Group 17-18 in Visit 08	470 Secs [==>]	[2]

Orbit 1

Orbit Structure

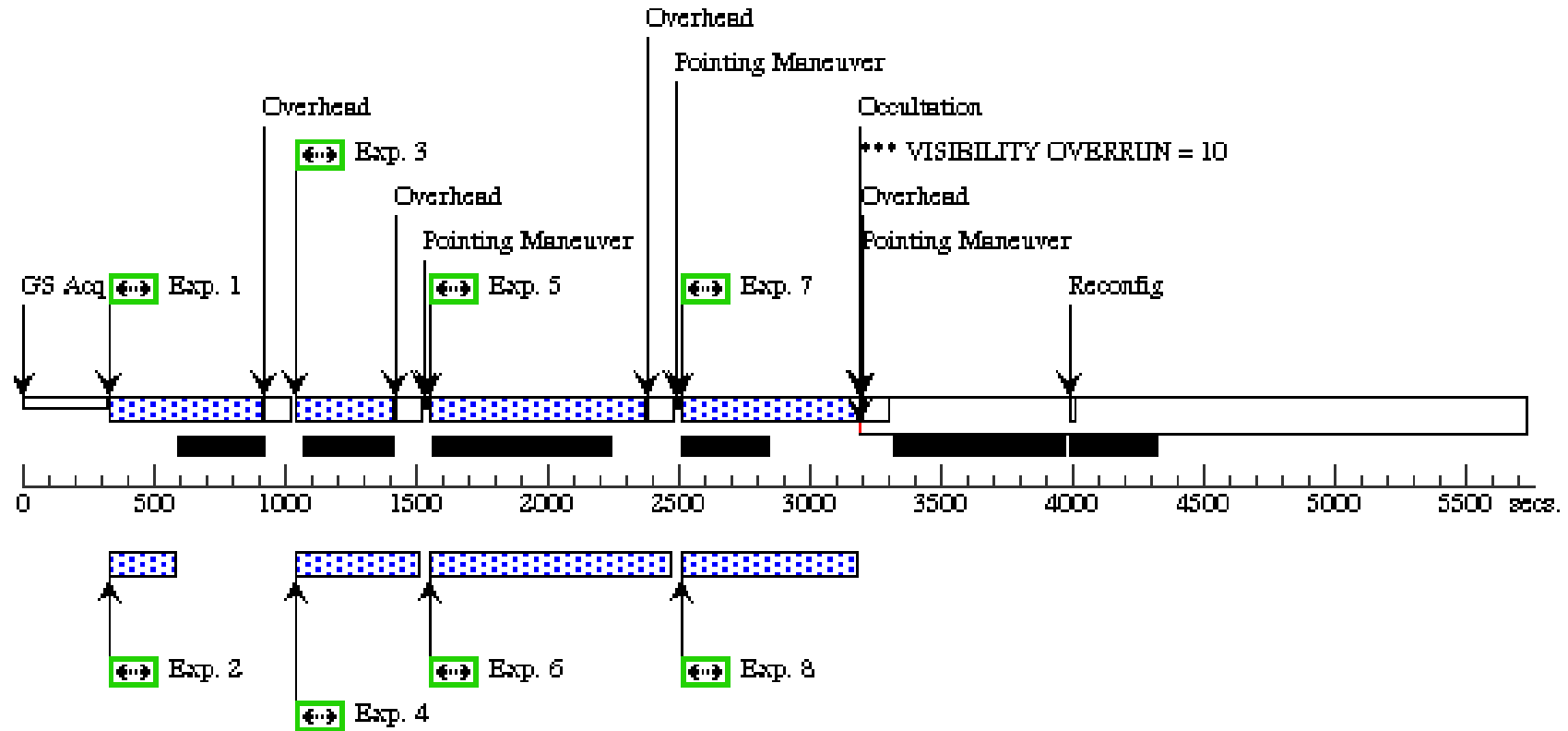

Orbit 2

Server Version: 20120604

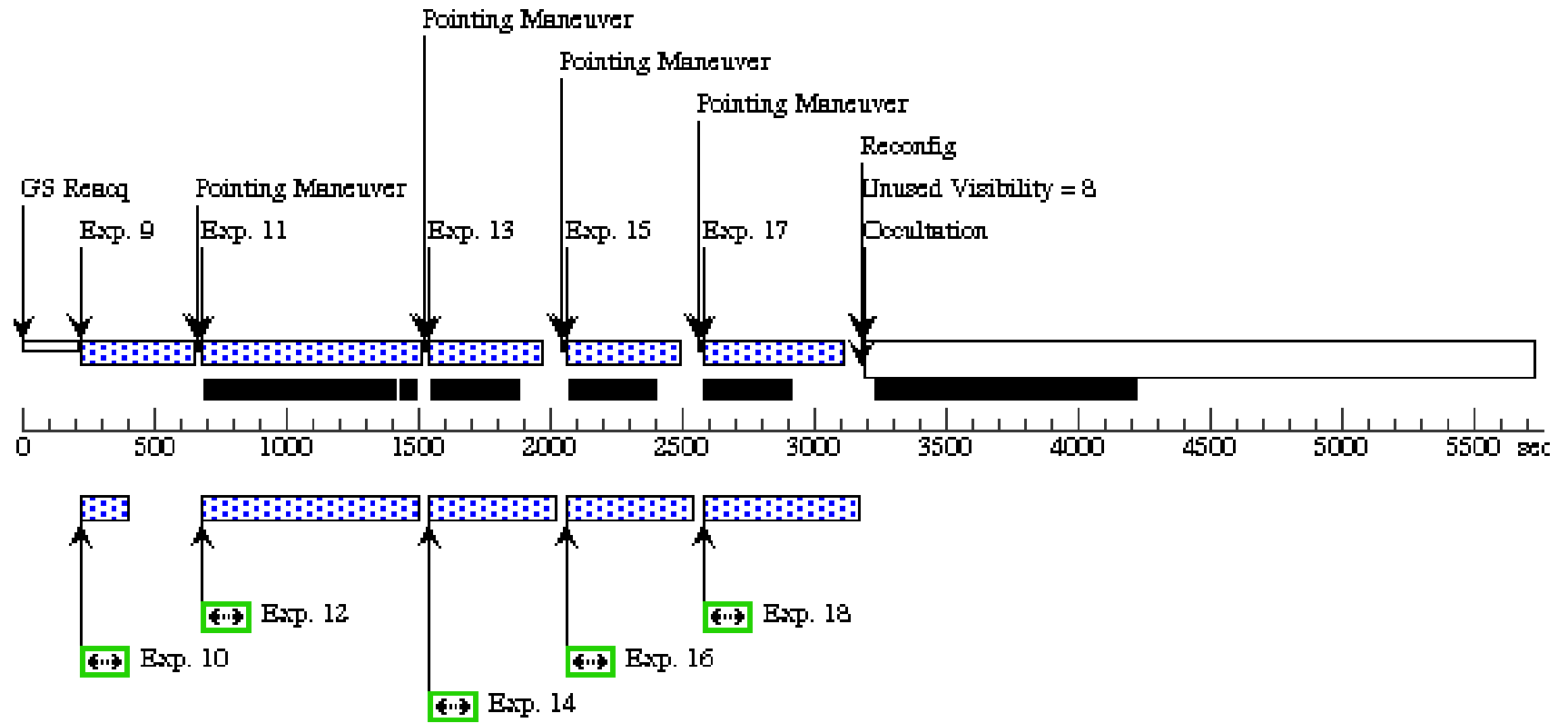

Proposal 12115 - Visit 09 - A Panchromatic Hubble Andromeda Treasury - I

Fri Jun 08 01:09:18 GMT 2012

Visit	Proposal 12115, Visit 09, implementation Diagnostic Status: Warning Scientific Instruments: WFC3/IR, WFC3/UVIS, ACS/WFC Special Requirements: SCHED 60%: ORIENT 54D TO 54 D					
Diagnostics	(Visit 09) Warning (Orbit Planner): VISIBILITY OVERRUN (Visit 09) Warning (Orbit Planner): PARALLELS SIGNIFICANTLY EXTEND ALIGNMENT TIME (Visit 09) Warning (Form): The 'SCHED=100' special requirement must be selected for this visit.					
Fixed Targets	#	Name	Target Coordinates	Targ. Coord. Corrections	Fluxes	Miscellaneous
	(25)	M31-B11-F09-IR	RA: 00 44 39.8709 (11.1661287d) Dec: +41 40 4.10 (41.66781d) Equinox: J2000		V=20+/-0.1	Reference Frame: ICRS
	(26)	M31-B11-F09-UVIS	RA: 00 44 39.8709 (11.1661287d) Dec: +41 40 4.10 (41.66781d) Equinox: J2000		V=20+/-0.1	Reference Frame: ICRS
	(27)	M31-B11-F12-WFC	RA: 00 44 39.8709 (11.1661287d) Dec: +41 40 4.10 (41.66781d) Equinox: J2000		V=20+/-0.1	Reference Frame: ICRS

Proposal 12115 - Visit 09 - A Panchromatic Hubble Andromeda Treasury - I

#	Label	Target	Config,Mode,Aperture	Spectral Els.	Opt. Params.	Special Reqs.	Groups	Exp. Time/[Actual Dur.]		Orbit
Exposures	1	M31-B11-F09-UVIS-F3 36W	(26) M31-B11-F09-UVIS	WFC3/UVIS, ACCUM, UVIS-CENTER	F336W	CR-SPLIT=NO	POS TARG 1.655,2.96	Prime + Parallel Group 1-2 in Visit 09	550 Secs [==>]	[1]
	2	M31-B11-F12-WFC-F8 14W-short	(27) M31-B11-F12-WFC	ACS/WFC, ACCUM, WFC	F814W			Prime + Parallel Group 1-2 in Visit 09	15 Secs [==>]	[1]
	3	M31-B11-F09-UVIS-F2 75W	(26) M31-B11-F09-UVIS	WFC3/UVIS, ACCUM, UVIS-CENTER	F275W	CR-SPLIT=NO	POS TARG 1.655,2.96	Prime + Parallel Group 3-4 in Visit 09	350 Secs [==>]	[1]
	4	M31-B11-F12-WFC-F8 14W	(27) M31-B11-F12-WFC	ACS/WFC, ACCUM, WFC	F814W			Prime + Parallel Group 3-4 in Visit 09	350 Secs [==>]	[1]
	5	M31-B11-F09-UVIS-F3 36W	(26) M31-B11-F09-UVIS	WFC3/UVIS, ACCUM, UVIS-CENTER	F336W	CR-SPLIT=NO	POS TARG 1.634,4.882	Prime + Parallel Group 5-6 in Visit 09	800 Secs [==>]	[1]
	6	M31-B11-F12-WFC-F8 14W	(27) M31-B11-F12-WFC	ACS/WFC, ACCUM, WFC	F814W			Prime + Parallel Group 5-6 in Visit 09	800 Secs [==>]	[1]
	7	M31-B11-F09-UVIS-F2 75W	(26) M31-B11-F09-UVIS	WFC3/UVIS, ACCUM, UVIS-CENTER	F275W	CR-SPLIT=NO	POS TARG 1.525,4.882	Prime + Parallel Group 7-8 in Visit 09	660 Secs [==>]	[1]
	8	M31-B11-F12-WFC-F8 14W	(27) M31-B11-F12-WFC	ACS/WFC, ACCUM, WFC	F814W			Prime + Parallel Group 7-8 in Visit 09	550 Secs [==>]	[1]
	9	M31-B11-F09-IR-f160w	(25) M31-B11-F09-IR	WFC3/IR, MULTIACCUM, IR-FIX	F160W	NSAMP=9; SAMP-SEQ=STEP200	POS TARG 0,0	Prime + Parallel Group 9-10 in Visit 09	[==>]	[2]
	10	M31-B11-F12-WFC-F4 75W-short	(27) M31-B11-F12-WFC	ACS/WFC, ACCUM, WFC	F475W			Prime + Parallel Group 9-10 in Visit 09	10 Secs [==>]	[2]
	11	M31-B11-F09-IR-f110w	(25) M31-B11-F09-IR	WFC3/IR, MULTIACCUM, IR-FIX	F110W	NSAMP=11; SAMP-SEQ=STEP200	POS TARG 0.187,0.086	Prime + Parallel Group 11-12 in Visit 09	[==>]	[2]
	12	M31-B11-F12-WFC-F4 75W	(27) M31-B11-F12-WFC	ACS/WFC, ACCUM, WFC	F475W			Prime + Parallel Group 11-12 in Visit 09	700 Secs [==>]	[2]
	13	M31-B11-F09-IR-f160w	(25) M31-B11-F09-IR	WFC3/IR, MULTIACCUM, IR-FIX	F160W	NSAMP=9; SAMP-SEQ=STEP200	POS TARG 0.206,0.171	Prime + Parallel Group 13-14 in Visit 09	[==>]	[2]
	14	M31-B11-F12-WFC-F4 75W	(27) M31-B11-F12-WFC	ACS/WFC, ACCUM, WFC	F475W			Prime + Parallel Group 13-14 in Visit 09	360 Secs [==>]	[2]
	15	M31-B11-F09-IR-f160w	(25) M31-B11-F09-IR	WFC3/IR, MULTIACCUM, IR-FIX	F160W	NSAMP=9; SAMP-SEQ=STEP200	POS TARG 0.263,0.188	Prime + Parallel Group 15-16 in Visit 09	[==>]	[2]
	16	M31-B11-F12-WFC-F4 75W	(27) M31-B11-F12-WFC	ACS/WFC, ACCUM, WFC	F475W			Prime + Parallel Group 15-16 in Visit 09	360 Secs [==>]	[2]
	17	M31-B11-F09-IR-f160w	(25) M31-B11-F09-IR	WFC3/IR, MULTIACCUM, IR-FIX	F160W	NSAMP=11; SAMP-SEQ=STEP100	POS TARG 0.204,-0.001	Prime + Parallel Group 17-18 in Visit 09	[==>]	[2]
	18	M31-B11-F12-WFC-F4 75W	(27) M31-B11-F12-WFC	ACS/WFC, ACCUM, WFC	F475W			Prime + Parallel Group 17-18 in Visit 09	470 Secs [==>]	[2]

Orbit 1

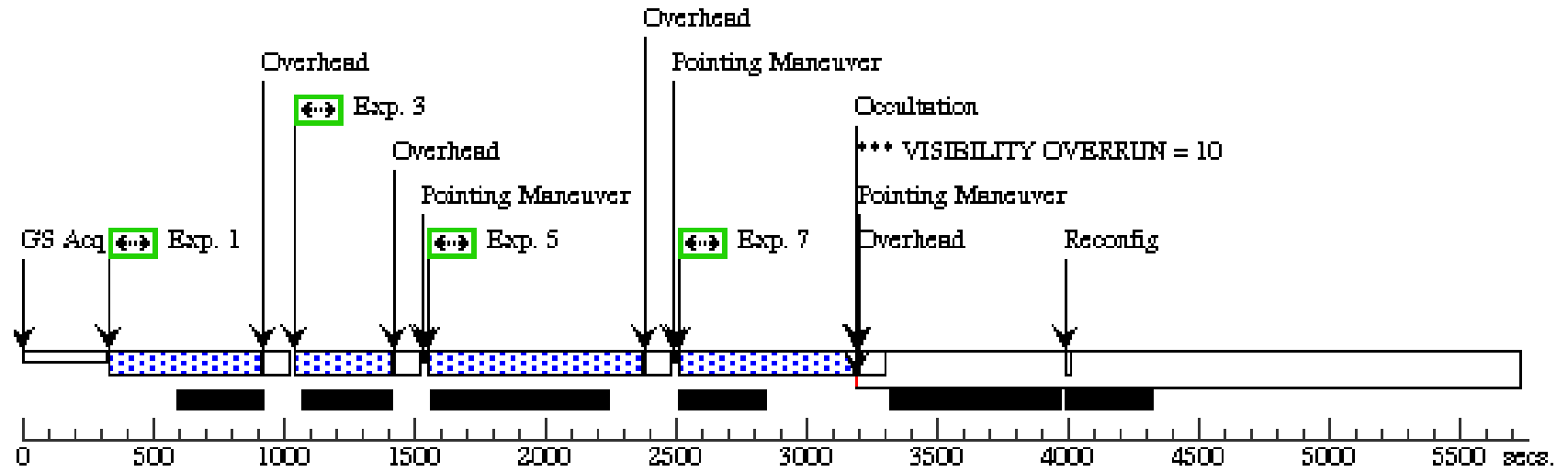

Orbit Structure

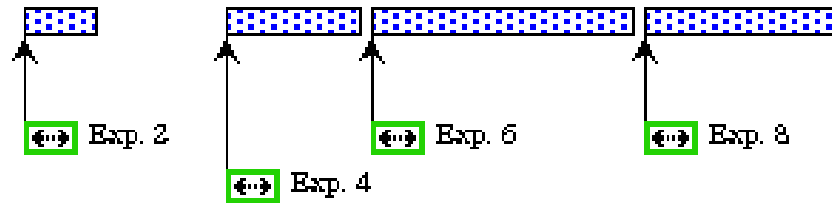

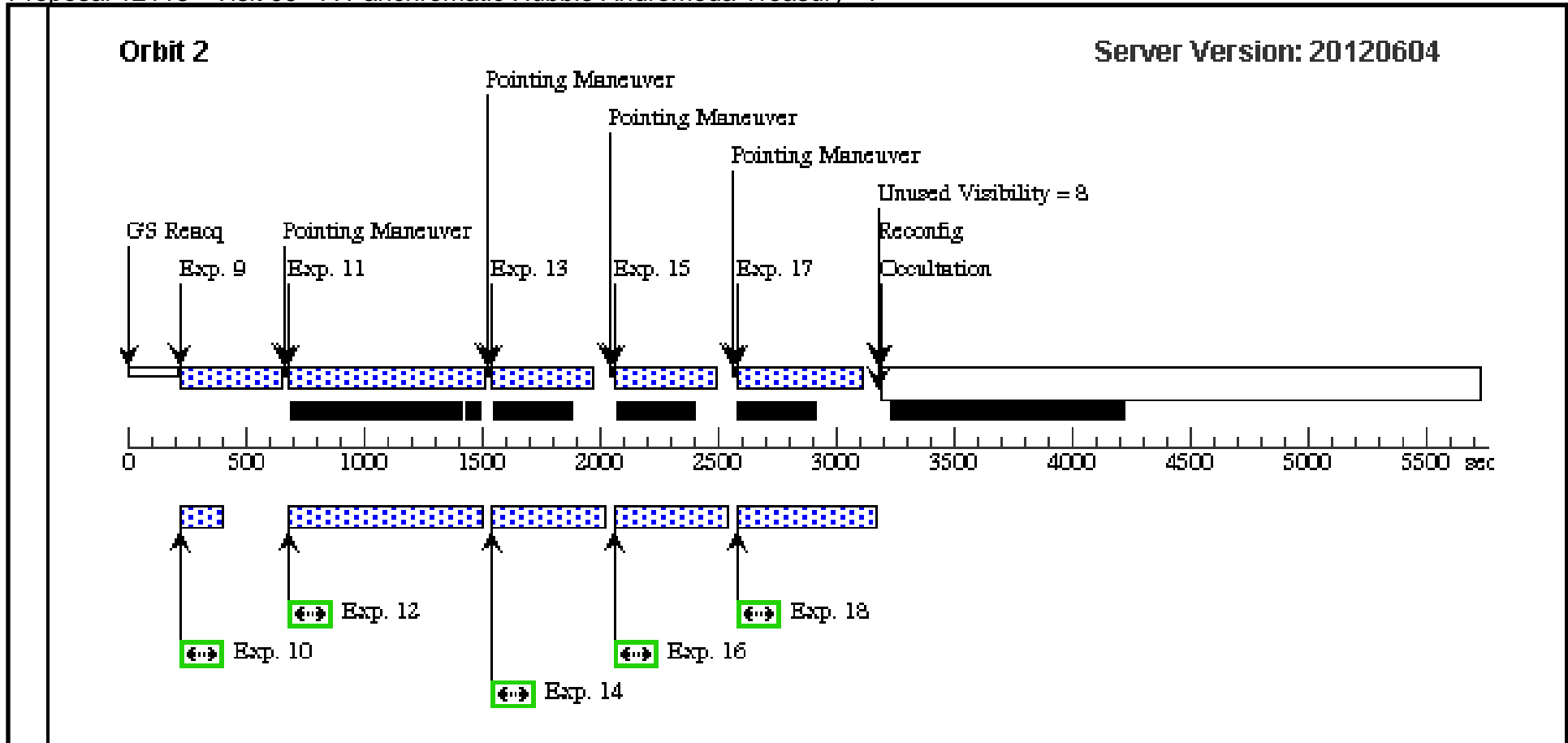

Proposal 12115 - Visit 10 - A Panchromatic Hubble Andromeda Treasury - I

Fri Jun 08 01:09:21 GMT 2012

Visit	Proposal 12115, Visit 10, implementation Diagnostic Status: Warning Scientific Instruments: WFC3/IR, WFC3/UVIS, ACS/WFC Special Requirements: SCHED 100%; ORIENT 234D TO 234 D					
Diagnostics	(Visit 10) Warning (Orbit Planner): VISIBILITY OVERRUN (Visit 10) Warning (Orbit Planner): PARALLELS SIGNIFICANTLY EXTEND ALIGNMENT TIME (Visit 10) Warning (Orbit Planner): PARALLELS SIGNIFICANTLY EXTEND ALIGNMENT TIME (Visit 10) Warning (Orbit Planner): PARALLELS SIGNIFICANTLY EXTEND ALIGNMENT TIME					
Fixed Targets	#	Name	Target Coordinates	Targ. Coord. Corrections	Fluxes	Miscellaneous
	(28)	M31-B11-F10-IR	RA: 00 44 29.1846 (11.1216025d) Dec: +41 40 22.68 (41.67297d) Equinox: J2000		V=20+/-0.1	Reference Frame: ICRS
	(29)	M31-B11-F10-UVIS	RA: 00 44 29.1846 (11.1216025d) Dec: +41 40 22.68 (41.67297d) Equinox: J2000		V=20+/-0.1	Reference Frame: ICRS
	(30)	M31-B11-F07-WFC	RA: 00 44 29.1846 (11.1216025d) Dec: +41 40 22.68 (41.67297d) Equinox: J2000		V=20+/-0.1	Reference Frame: ICRS

Proposal 12115 - Visit 10 - A Panchromatic Hubble Andromeda Treasury - I

#	Label	Target	Config,Mode,Aperture	Spectral Els.	Opt. Params.	Special Reqs.	Groups	Exp. Time/[Actual Dur.]	Orbit	
Exposures	1	M31-B11-F 10-UVIS-F3 36W	(29) M31-B11-F10- UVIS	WFC3/UVIS, ACCUM, UVIS-CENTER	F336W	CR-SPLIT=NO	POS TARG 1.655,2. 96	Prime + Parallel Gro up 1-2 in Visit 10	550 Secs [==>]	[1]
	2	M31-B11-F 07-WFC-F8 14W-short	(30) M31-B11-F07- WFC	ACS/WFC, ACCUM, WFC	F814W			Prime + Parallel Gro up 1-2 in Visit 10	15 Secs [==>]	[1]
	3	M31-B11-F 10-UVIS-F2 75W	(29) M31-B11-F10- UVIS	WFC3/UVIS, ACCUM, UVIS-CENTER	F275W	CR-SPLIT=NO	POS TARG 1.655,2. 96	Prime + Parallel Gro up 3-4 in Visit 10	350 Secs [==>]	[1]
	4	M31-B11-F 07-WFC-F8 14W	(30) M31-B11-F07- WFC	ACS/WFC, ACCUM, WFC	F814W			Prime + Parallel Gro up 3-4 in Visit 10	350 Secs [==>]	[1]
	5	M31-B11-F 10-UVIS-F3 36W	(29) M31-B11-F10- UVIS	WFC3/UVIS, ACCUM, UVIS-CENTER	F336W	CR-SPLIT=NO	POS TARG 1.634,4. 882	Prime + Parallel Gro up 5-6 in Visit 10	700 Secs [==>]	[1]
	6	M31-B11-F 07-WFC-F8 14W	(30) M31-B11-F07- WFC	ACS/WFC, ACCUM, WFC	F814W			Prime + Parallel Gro up 5-6 in Visit 10	700 Secs [==>]	[1]
	7	M31-B11-F 10-UVIS-F2 75W	(29) M31-B11-F10- UVIS	WFC3/UVIS, ACCUM, UVIS-CENTER	F275W	CR-SPLIT=NO	POS TARG 1.525,4. 882	Prime + Parallel Gro up 7-8 in Visit 10	575 Secs [==>]	[1]
	8	M31-B11-F 07-WFC-F8 14W	(30) M31-B11-F07- WFC	ACS/WFC, ACCUM, WFC	F814W			Prime + Parallel Gro up 7-8 in Visit 10	455 Secs [==>]	[1]
	9	M31-B11-F 10-IR-f160 w	(28) M31-B11-F10-I R	WFC3/IR, MULTIACCUM, IR-FIX	F160W	NSAMP=9; SAMP-SEQ=STEP2 00	POS TARG 0,0	Prime + Parallel Gro up 9-10 in Visit 10	[==>]	[2]
	10	M31-B11-F 07-WFC-F4 75W-short	(30) M31-B11-F07- WFC	ACS/WFC, ACCUM, WFC	F475W			Prime + Parallel Gro up 9-10 in Visit 10	10 Secs [==>]	[2]
	11	M31-B11-F 10-IR-f110 w	(28) M31-B11-F10-I R	WFC3/IR, MULTIACCUM, IR-FIX	F110W	NSAMP=13; SAMP-SEQ=STEP1 00	POS TARG 0.187,0. 086	Prime + Parallel Gro up 11-12 in Visit 10	[==>]	[2]
	12	M31-B11-F 07-WFC-F4 75W	(30) M31-B11-F07- WFC	ACS/WFC, ACCUM, WFC	F475W			Prime + Parallel Gro up 11-12 in Visit 10	600 Secs [==>]	[2]
	13	M31-B11-F 10-IR-f160 w	(28) M31-B11-F10-I R	WFC3/IR, MULTIACCUM, IR-FIX	F160W	NSAMP=9; SAMP-SEQ=STEP2 00	POS TARG 0.206,0. 171	Prime + Parallel Gro up 13-14 in Visit 10	[==>]	[2]
	14	M31-B11-F 07-WFC-F4 75W	(30) M31-B11-F07- WFC	ACS/WFC, ACCUM, WFC	F475W			Prime + Parallel Gro up 13-14 in Visit 10	370 Secs [==>]	[2]
	15	M31-B11-F 10-IR-f160 w	(28) M31-B11-F10-I R	WFC3/IR, MULTIACCUM, IR-FIX	F160W	NSAMP=9; SAMP-SEQ=STEP2 00	POS TARG 0.263,0. 188	Prime + Parallel Gro up 15-16 in Visit 10	[==>]	[2]
	16	M31-B11-F 07-WFC-F4 75W	(30) M31-B11-F07- WFC	ACS/WFC, ACCUM, WFC	F475W			Prime + Parallel Gro up 15-16 in Visit 10	370 Secs [==>]	[2]
	17	M31-B11-F 10-IR-f160 w	(28) M31-B11-F10-I R	WFC3/IR, MULTIACCUM, IR-FIX	F160W	NSAMP=9; SAMP-SEQ=STEP2 00	POS TARG 0.204,-0 .001	Prime + Parallel Gro up 17-18 in Visit 10	[==>]	[2]
	18	M31-B11-F 07-WFC-F4 75W	(30) M31-B11-F07- WFC	ACS/WFC, ACCUM, WFC	F475W			Prime + Parallel Gro up 17-18 in Visit 10	370 Secs [==>]	[2]

Orbit 1

Server Version: 20120604

Orbit Structure

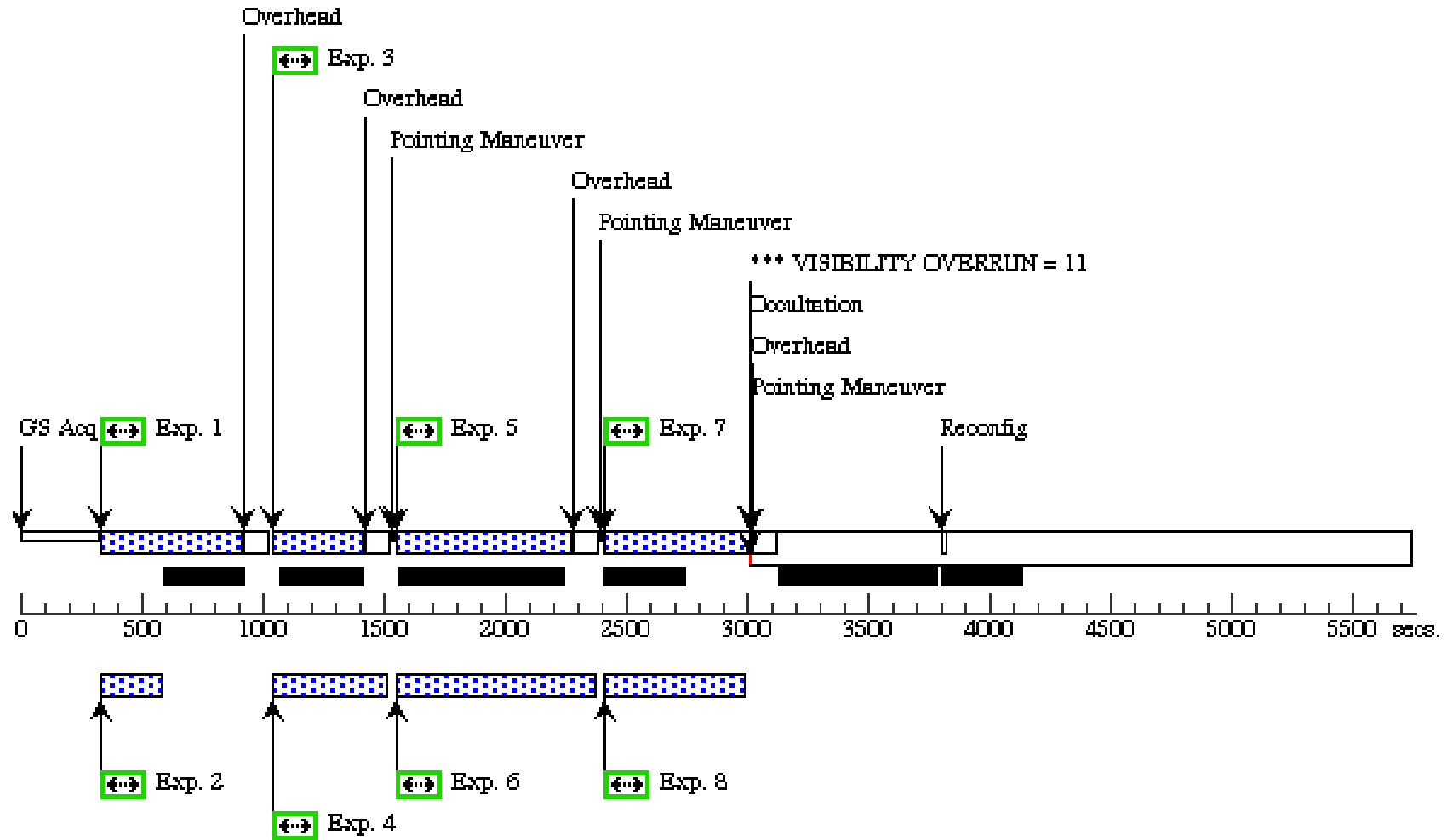

Orbit 2

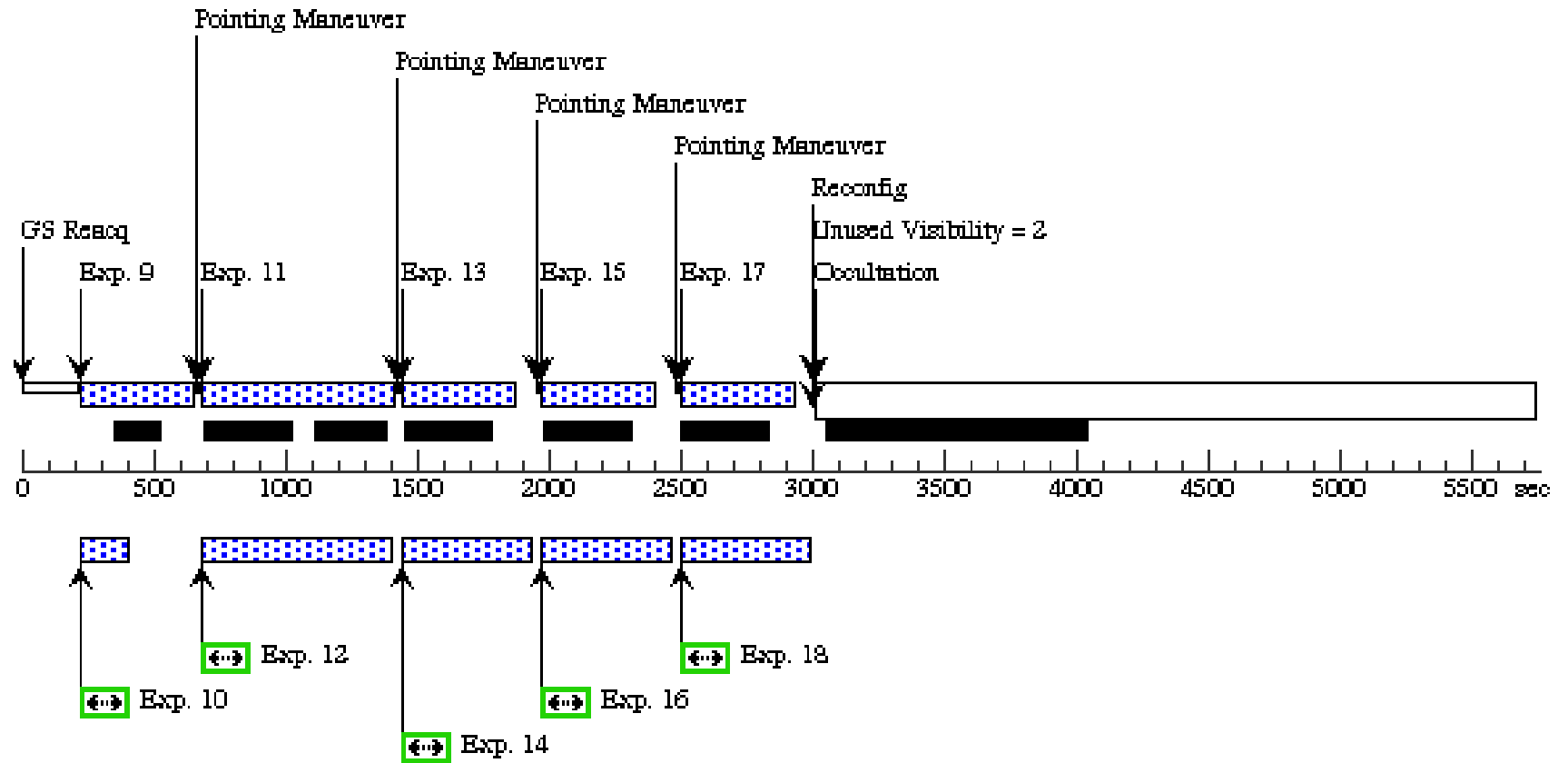

Proposal 12115 - Visit 11 - A Panchromatic Hubble Andromeda Treasury - I

Fri Jun 08 01:09:24 GMT 2012

Visit	Proposal 12115, Visit 11, implementation Diagnostic Status: Warning Scientific Instruments: WFC3/IR, WFC3/UVIS, ACS/WFC Special Requirements: SCHED 100%; ORIENT 234D TO 234 D					
	(Visit 11) Warning (Orbit Planner): PARALLELS SIGNIFICANTLY EXTEND ALIGNMENT TIME (Visit 11) Warning (Orbit Planner): PARALLELS SIGNIFICANTLY EXTEND ALIGNMENT TIME (Visit 11) Warning (Orbit Planner): PARALLELS SIGNIFICANTLY EXTEND ALIGNMENT TIME (Visit 11) Warning (Orbit Planner): VISIBILITY OVERRUN					
Fixed Targets	#	Name	Target Coordinates	Targ. Coord. Corrections	Fluxes	Miscellaneous
	(31)	M31-B11-F11-IR	RA: 00 44 18.7125 (11.0779688d) Dec: +41 40 41.27 (41.67813d) Equinox: J2000		V=20+/-0.1	Reference Frame: ICRS
	(32)	M31-B11-F11-UVIS	RA: 00 44 18.7125 (11.0779688d) Dec: +41 40 41.27 (41.67813d) Equinox: J2000		V=20+/-0.1	Reference Frame: ICRS
	(33)	M31-B11-F08-WFC	RA: 00 44 18.7125 (11.0779688d) Dec: +41 40 41.27 (41.67813d) Equinox: J2000		V=20+/-0.1	Reference Frame: ICRS

Proposal 12115 - Visit 11 - A Panchromatic Hubble Andromeda Treasury - I

#	Label	Target	Config,Mode,Aperture	Spectral Els.	Opt. Params.	Special Reqs.	Groups	Exp. Time/[Actual Dur.]	Orbit	
Exposures	1	M31-B11-F 11-UVIS-F3 36W	(32) M31-B11-F11- UVIS	WFC3/UVIS, ACCUM, UVIS-CENTER	F336W	CR-SPLIT=NO	POS TARG 1.655,2. 96	Prime + Parallel Gro up 1-2 in Visit 11	550 Secs [==>]	[1]
	2	M31-B11-F 08-WFC-F8 14W-short	(33) M31-B11-F08- WFC	ACS/WFC, ACCUM, WFC	F814W			Prime + Parallel Gro up 1-2 in Visit 11	15 Secs [==>]	[1]
	3	M31-B11-F 11-UVIS-F2 75W	(32) M31-B11-F11- UVIS	WFC3/UVIS, ACCUM, UVIS-CENTER	F275W	CR-SPLIT=NO	POS TARG 1.655,2. 96	Prime + Parallel Gro up 3-4 in Visit 11	350 Secs [==>]	[1]
	4	M31-B11-F 08-WFC-F8 14W	(33) M31-B11-F08- WFC	ACS/WFC, ACCUM, WFC	F814W			Prime + Parallel Gro up 3-4 in Visit 11	350 Secs [==>]	[1]
	5	M31-B11-F 11-UVIS-F3 36W	(32) M31-B11-F11- UVIS	WFC3/UVIS, ACCUM, UVIS-CENTER	F336W	CR-SPLIT=NO	POS TARG 1.634,4. 882	Prime + Parallel Gro up 5-6 in Visit 11	700 Secs [==>]	[1]
	6	M31-B11-F 08-WFC-F8 14W	(33) M31-B11-F08- WFC	ACS/WFC, ACCUM, WFC	F814W			Prime + Parallel Gro up 5-6 in Visit 11	700 Secs [==>]	[1]
	7	M31-B11-F 11-UVIS-F2 75W	(32) M31-B11-F11- UVIS	WFC3/UVIS, ACCUM, UVIS-CENTER	F275W	CR-SPLIT=NO	POS TARG 1.525,4. 882	Prime + Parallel Gro up 7-8 in Visit 11	575 Secs [==>]	[1]
	8	M31-B11-F 08-WFC-F8 14W	(33) M31-B11-F08- WFC	ACS/WFC, ACCUM, WFC	F814W			Prime + Parallel Gro up 7-8 in Visit 11	455 Secs [==>]	[1]
	9	M31-B11-F 11-IR-f160 w	(31) M31-B11-F11-I R	WFC3/IR, MULTIACCUM, IR-FIX	F160W	NSAMP=9; SAMP-SEQ=STEP2 00	POS TARG 0,0	Prime + Parallel Gro up 9-10 in Visit 11	[==>]	[2]
	10	M31-B11-F 08-WFC-F4 75W-short	(33) M31-B11-F08- WFC	ACS/WFC, ACCUM, WFC	F475W			Prime + Parallel Gro up 9-10 in Visit 11	10 Secs [==>]	[2]
	11	M31-B11-F 11-IR-f110 w	(31) M31-B11-F11-I R	WFC3/IR, MULTIACCUM, IR-FIX	F110W	NSAMP=13; SAMP-SEQ=STEP1 00	POS TARG 0.187,0. 086	Prime + Parallel Gro up 11-12 in Visit 11	[==>]	[2]
	12	M31-B11-F 08-WFC-F4 75W	(33) M31-B11-F08- WFC	ACS/WFC, ACCUM, WFC	F475W			Prime + Parallel Gro up 11-12 in Visit 11	600 Secs [==>]	[2]
	13	M31-B11-F 11-IR-f160 w	(31) M31-B11-F11-I R	WFC3/IR, MULTIACCUM, IR-FIX	F160W	NSAMP=9; SAMP-SEQ=STEP2 00	POS TARG 0.206,0. 171	Prime + Parallel Gro up 13-14 in Visit 11	[==>]	[2]
	14	M31-B11-F 08-WFC-F4 75W	(33) M31-B11-F08- WFC	ACS/WFC, ACCUM, WFC	F475W			Prime + Parallel Gro up 13-14 in Visit 11	370 Secs [==>]	[2]
	15	M31-B11-F 11-IR-f160 w	(31) M31-B11-F11-I R	WFC3/IR, MULTIACCUM, IR-FIX	F160W	NSAMP=9; SAMP-SEQ=STEP2 00	POS TARG 0.263,0. 188	Prime + Parallel Gro up 15-16 in Visit 11	[==>]	[2]
	16	M31-B11-F 08-WFC-F4 75W	(33) M31-B11-F08- WFC	ACS/WFC, ACCUM, WFC	F475W			Prime + Parallel Gro up 15-16 in Visit 11	370 Secs [==>]	[2]
	17	M31-B11-F 11-IR-f160 w	(31) M31-B11-F11-I R	WFC3/IR, MULTIACCUM, IR-FIX	F160W	NSAMP=9; SAMP-SEQ=STEP2 00	POS TARG 0.204,-0 .001	Prime + Parallel Gro up 17-18 in Visit 11	[==>]	[2]
	18	M31-B11-F 08-WFC-F4 75W	(33) M31-B11-F08- WFC	ACS/WFC, ACCUM, WFC	F475W			Prime + Parallel Gro up 17-18 in Visit 11	370 Secs [==>]	[2]

Orbit 1

Orbit Structure

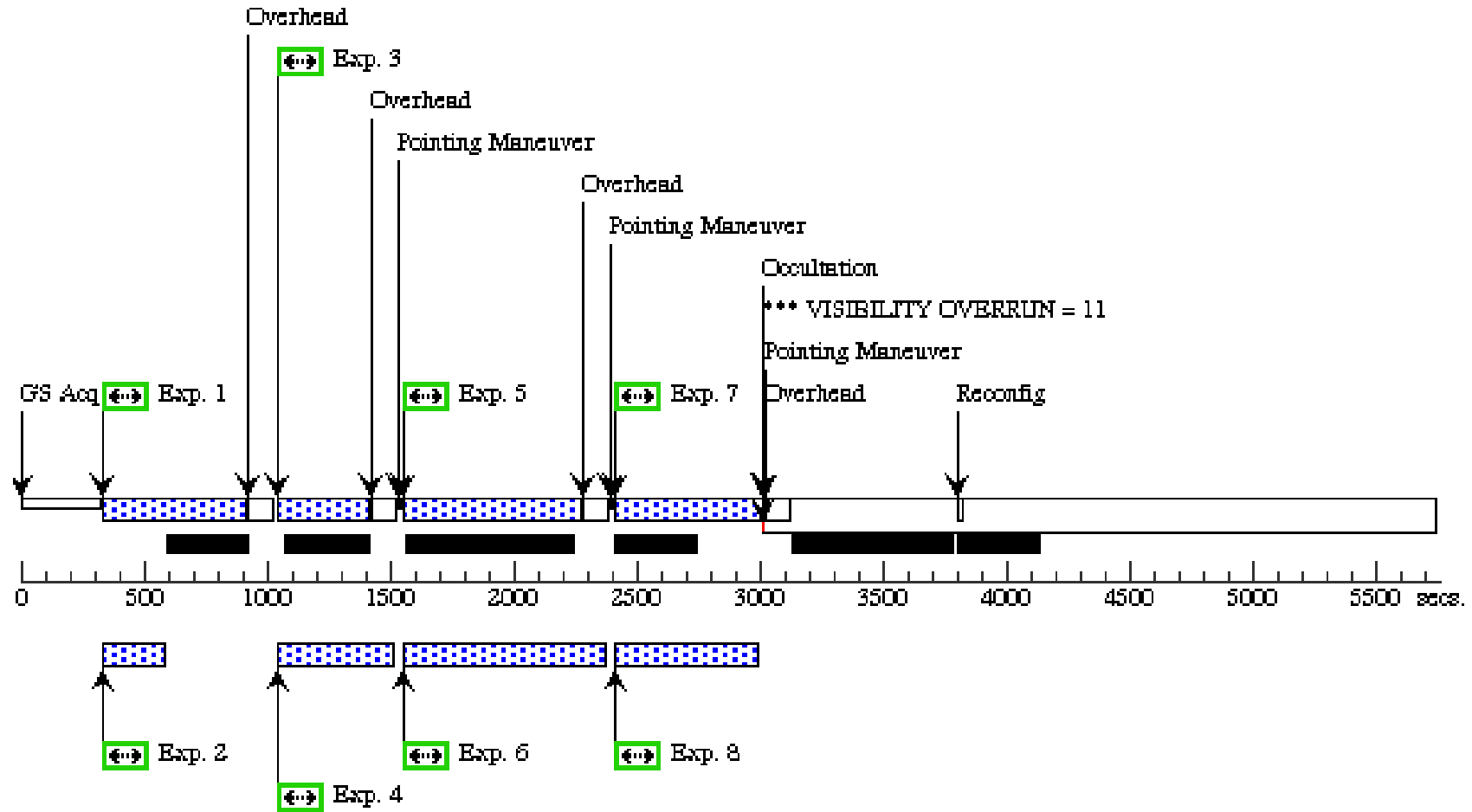

Orbit 2

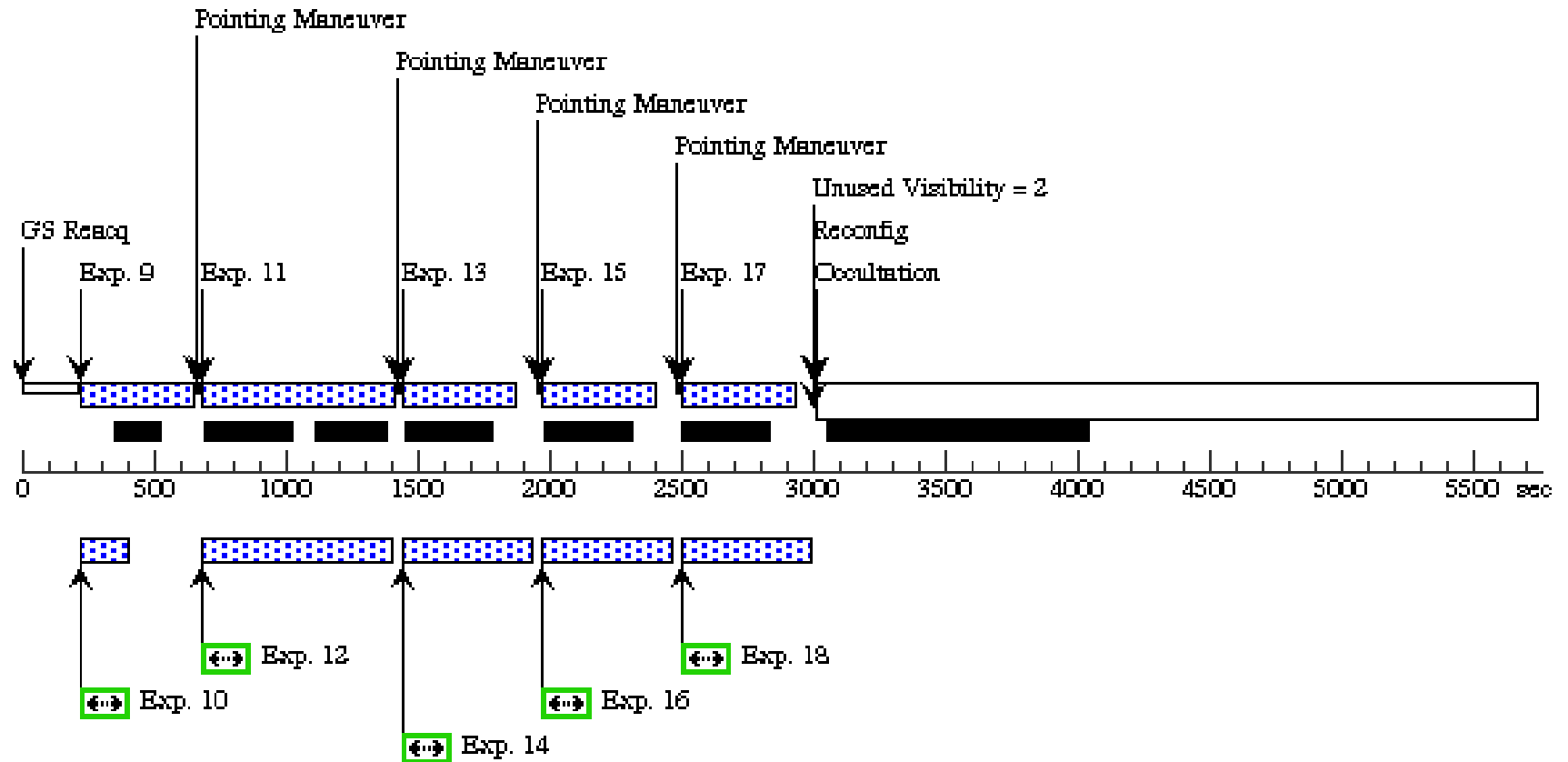

Proposal 12115 - Visit 12 - A Panchromatic Hubble Andromeda Treasury - I

Fri Jun 08 01:09:27 GMT 2012

Visit	Proposal 12115, Visit 12, implementation Diagnostic Status: Warning Scientific Instruments: WFC3/IR, WFC3/UVIS, ACS/WFC Special Requirements: SCHED 100%; ORIENT 234D TO 234 D					
Diagnostics	(Visit 12) Warning (Orbit Planner): VISIBILITY OVERRUN (Visit 12) Warning (Orbit Planner): PARALLELS SIGNIFICANTLY EXTEND ALIGNMENT TIME (Visit 12) Warning (Orbit Planner): PARALLELS SIGNIFICANTLY EXTEND ALIGNMENT TIME (Visit 12) Warning (Orbit Planner): PARALLELS SIGNIFICANTLY EXTEND ALIGNMENT TIME					
Fixed Targets	#	Name	Target Coordinates	Targ. Coord. Corrections	Fluxes	Miscellaneous
	(34)	M31-B11-F12-IR	RA: 00 44 8.2404 (11.0343350d) Dec: +41 40 59.85 (41.68329d) Equinox: J2000		V=20+/-0.1	Reference Frame: ICRS
	(35)	M31-B11-F12-UVIS	RA: 00 44 8.2404 (11.0343350d) Dec: +41 40 59.85 (41.68329d) Equinox: J2000		V=20+/-0.1	Reference Frame: ICRS
	(36)	M31-B11-F09-WFC	RA: 00 44 8.2404 (11.0343350d) Dec: +41 40 59.85 (41.68329d) Equinox: J2000		V=20+/-0.1	Reference Frame: ICRS

Proposal 12115 - Visit 12 - A Panchromatic Hubble Andromeda Treasury - I

#	Label	Target	Config,Mode,Aperture	Spectral Els.	Opt. Params.	Special Reqs.	Groups	Exp. Time/[Actual Dur.]	Orbit	
Exposures	1	M31-B11-F 12-UVIS-F3 36W	(35) M31-B11-F12- UVIS	WFC3/UVIS, ACCUM, UVIS-CENTER	F336W	CR-SPLIT=NO	POS TARG 1.655,2. 96	Prime + Parallel Gro up 1-2 in Visit 12	550 Secs [==>]	[1]
	2	M31-B11-F 09-WFC-F8 14W-short	(36) M31-B11-F09- WFC	ACS/WFC, ACCUM, WFC	F814W			Prime + Parallel Gro up 1-2 in Visit 12	15 Secs [==>]	[1]
	3	M31-B11-F 12-UVIS-F2 75W	(35) M31-B11-F12- UVIS	WFC3/UVIS, ACCUM, UVIS-CENTER	F275W	CR-SPLIT=NO	POS TARG 1.655,2. 96	Prime + Parallel Gro up 3-4 in Visit 12	350 Secs [==>]	[1]
	4	M31-B11-F 09-WFC-F8 14W	(36) M31-B11-F09- WFC	ACS/WFC, ACCUM, WFC	F814W			Prime + Parallel Gro up 3-4 in Visit 12	350 Secs [==>]	[1]
	5	M31-B11-F 12-UVIS-F3 36W	(35) M31-B11-F12- UVIS	WFC3/UVIS, ACCUM, UVIS-CENTER	F336W	CR-SPLIT=NO	POS TARG 1.634,4. 882	Prime + Parallel Gro up 5-6 in Visit 12	700 Secs [==>]	[1]
	6	M31-B11-F 09-WFC-F8 14W	(36) M31-B11-F09- WFC	ACS/WFC, ACCUM, WFC	F814W			Prime + Parallel Gro up 5-6 in Visit 12	700 Secs [==>]	[1]
	7	M31-B11-F 12-UVIS-F2 75W	(35) M31-B11-F12- UVIS	WFC3/UVIS, ACCUM, UVIS-CENTER	F275W	CR-SPLIT=NO	POS TARG 1.525,4. 882	Prime + Parallel Gro up 7-8 in Visit 12	575 Secs [==>]	[1]
	8	M31-B11-F 09-WFC-F8 14W	(36) M31-B11-F09- WFC	ACS/WFC, ACCUM, WFC	F814W			Prime + Parallel Gro up 7-8 in Visit 12	455 Secs [==>]	[1]
	9	M31-B11-F 12-IR-f160 w	(34) M31-B11-F12-I R	WFC3/IR, MULTIACCUM, IR-FIX	F160W	NSAMP=9; SAMP-SEQ=STEP2 00	POS TARG 0,0	Prime + Parallel Gro up 9-10 in Visit 12	[==>]	[2]
	10	M31-B11-F 09-WFC-F4 75W-short	(36) M31-B11-F09- WFC	ACS/WFC, ACCUM, WFC	F475W			Prime + Parallel Gro up 9-10 in Visit 12	10 Secs [==>]	[2]
	11	M31-B11-F 12-IR-f110 w	(34) M31-B11-F12-I R	WFC3/IR, MULTIACCUM, IR-FIX	F110W	NSAMP=13; SAMP-SEQ=STEP1 00	POS TARG 0.187,0. 086	Prime + Parallel Gro up 11-12 in Visit 12	[==>]	[2]
	12	M31-B11-F 09-WFC-F4 75W	(36) M31-B11-F09- WFC	ACS/WFC, ACCUM, WFC	F475W			Prime + Parallel Gro up 11-12 in Visit 12	600 Secs [==>]	[2]
	13	M31-B11-F 12-IR-f160 w	(34) M31-B11-F12-I R	WFC3/IR, MULTIACCUM, IR-FIX	F160W	NSAMP=9; SAMP-SEQ=STEP2 00	POS TARG 0.206,0. 171	Prime + Parallel Gro up 13-14 in Visit 12	[==>]	[2]
	14	M31-B11-F 09-WFC-F4 75W	(36) M31-B11-F09- WFC	ACS/WFC, ACCUM, WFC	F475W			Prime + Parallel Gro up 13-14 in Visit 12	370 Secs [==>]	[2]
	15	M31-B11-F 12-IR-f160 w	(34) M31-B11-F12-I R	WFC3/IR, MULTIACCUM, IR-FIX	F160W	NSAMP=9; SAMP-SEQ=STEP2 00	POS TARG 0.263,0. 188	Prime + Parallel Gro up 15-16 in Visit 12	[==>]	[2]
	16	M31-B11-F 09-WFC-F4 75W	(36) M31-B11-F09- WFC	ACS/WFC, ACCUM, WFC	F475W			Prime + Parallel Gro up 15-16 in Visit 12	370 Secs [==>]	[2]
	17	M31-B11-F 12-IR-f160 w	(34) M31-B11-F12-I R	WFC3/IR, MULTIACCUM, IR-FIX	F160W	NSAMP=9; SAMP-SEQ=STEP2 00	POS TARG 0.204,-0 .001	Prime + Parallel Gro up 17-18 in Visit 12	[==>]	[2]
	18	M31-B11-F 09-WFC-F4 75W	(36) M31-B11-F09- WFC	ACS/WFC, ACCUM, WFC	F475W			Prime + Parallel Gro up 17-18 in Visit 12	370 Secs [==>]	[2]

Orbit 1

Orbit Structure

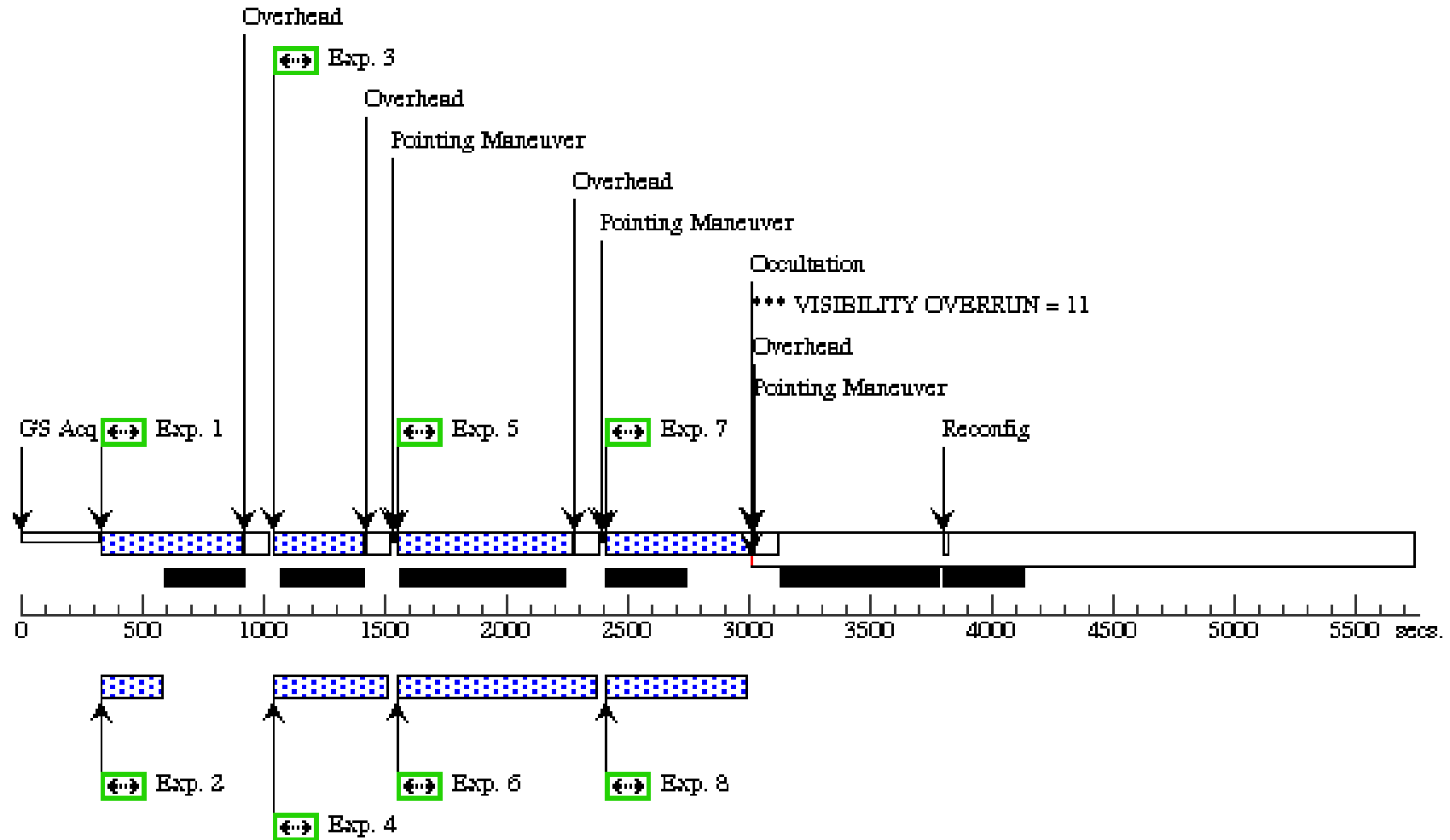

Orbit 2

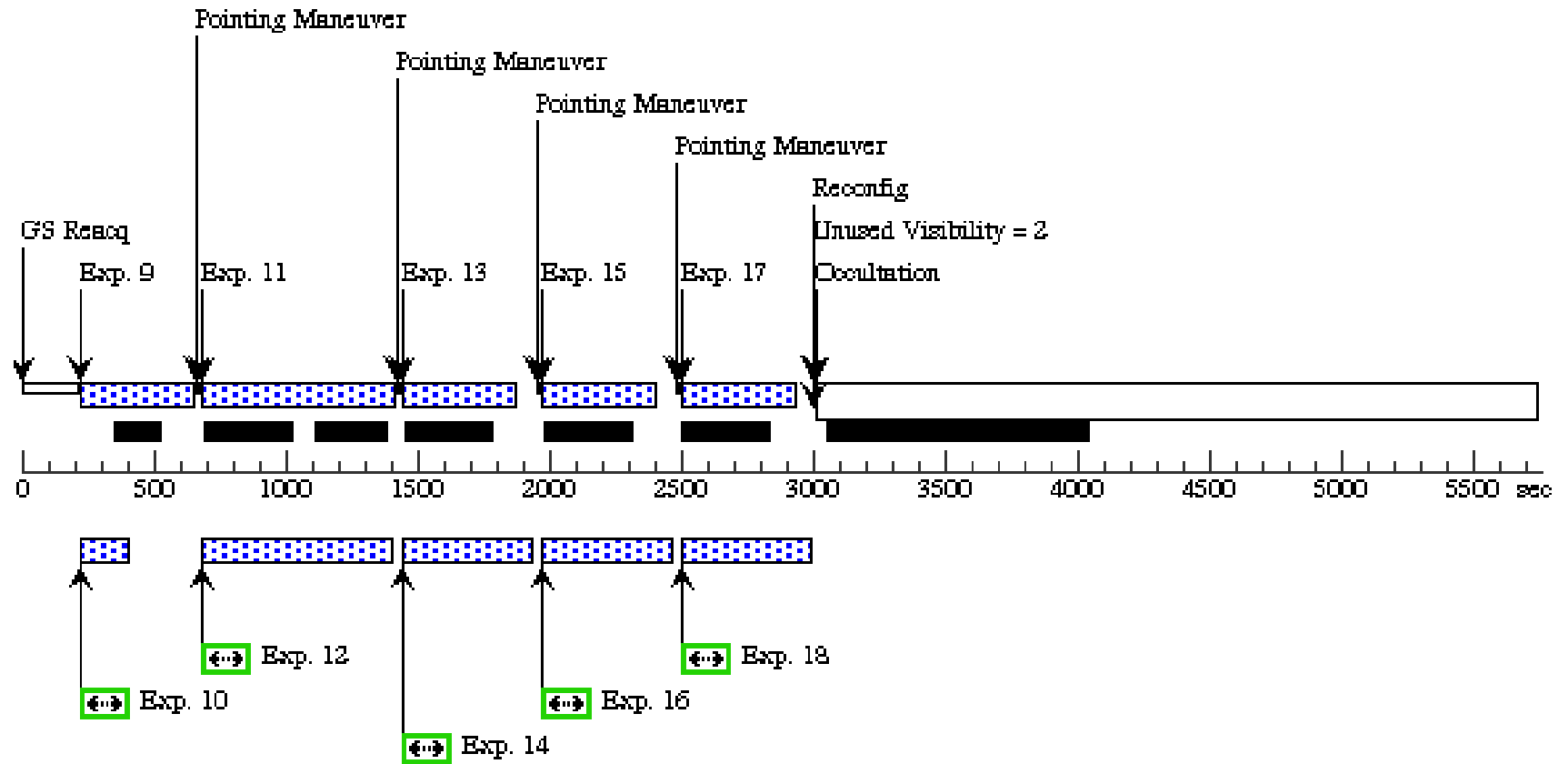

Proposal 12115 - Visit 13 - A Panchromatic Hubble Andromeda Treasury - I

Fri Jun 08 01:09:30 GMT 2012

Visit	Proposal 12115, Visit 13, implementation Diagnostic Status: Warning Scientific Instruments: WFC3/IR, WFC3/UVIS, ACS/WFC Special Requirements: SCHED 60%: ORIENT 54D TO 54 D					
Diagnostics	(Visit 13) Warning (Orbit Planner): PARALLELS SIGNIFICANTLY EXTEND ALIGNMENT TIME (Visit 13) Warning (Form): The 'SCHED=100' special requirement must be selected for this visit. (Visit 13) Warning (Orbit Planner): VISIBILITY OVERRUN					
Fixed Targets	#	Name	Target Coordinates	Targ. Coord. Corrections	Fluxes	Miscellaneous
	(37)	M31-B11-F13-IR	RA: 00 44 58.9471 (11.2456129d) Dec: +41 37 14.78 (41.62077d) Equinox: J2000		V=20+/-0.1	Reference Frame: ICRS
	(38)	M31-B11-F13-UVIS	RA: 00 44 58.9471 (11.2456129d) Dec: +41 37 14.78 (41.62077d) Equinox: J2000		V=20+/-0.1	Reference Frame: ICRS
	(39)	M31-B11-F16-WFC	RA: 00 44 58.9471 (11.2456129d) Dec: +41 37 14.78 (41.62077d) Equinox: J2000		V=20+/-0.1	Reference Frame: ICRS

Proposal 12115 - Visit 13 - A Panchromatic Hubble Andromeda Treasury - I

#	Label	Target	Config,Mode,Aperture	Spectral Els.	Opt. Params.	Special Reqs.	Groups	Exp. Time/[Actual Dur.]	Orbit	
Exposures	1	M31-B11-F 13-UVIS-F3 36W	(38) M31-B11-F13-UVIS	WFC3/UVIS, ACCUM, UVIS-CENTER	F336W	CR-SPLIT=NO	POS TARG 1.655,2.96	Prime + Parallel Group 1-2 in Visit 13	550 Secs [==>]	[1]
	2	M31-B11-F 16-WFC-F8 14W-short	(39) M31-B11-F16-WFC	ACS/WFC, ACCUM, WFC	F814W			Prime + Parallel Group 1-2 in Visit 13	15 Secs [==>]	[1]
	3	M31-B11-F 13-UVIS-F2 75W	(38) M31-B11-F13-UVIS	WFC3/UVIS, ACCUM, UVIS-CENTER	F275W	CR-SPLIT=NO	POS TARG 1.655,2.96	Prime + Parallel Group 3-4 in Visit 13	350 Secs [==>]	[1]
	4	M31-B11-F 16-WFC-F8 14W	(39) M31-B11-F16-WFC	ACS/WFC, ACCUM, WFC	F814W			Prime + Parallel Group 3-4 in Visit 13	350 Secs [==>]	[1]
	5	M31-B11-F 13-UVIS-F3 36W	(38) M31-B11-F13-UVIS	WFC3/UVIS, ACCUM, UVIS-CENTER	F336W	CR-SPLIT=NO	POS TARG 1.634,4.882	Prime + Parallel Group 5-6 in Visit 13	800 Secs [==>]	[1]
	6	M31-B11-F 16-WFC-F8 14W	(39) M31-B11-F16-WFC	ACS/WFC, ACCUM, WFC	F814W			Prime + Parallel Group 5-6 in Visit 13	800 Secs [==>]	[1]
	7	M31-B11-F 13-UVIS-F2 75W	(38) M31-B11-F13-UVIS	WFC3/UVIS, ACCUM, UVIS-CENTER	F275W	CR-SPLIT=NO	POS TARG 1.525,4.882	Prime + Parallel Group 7-8 in Visit 13	660 Secs [==>]	[1]
	8	M31-B11-F 16-WFC-F8 14W	(39) M31-B11-F16-WFC	ACS/WFC, ACCUM, WFC	F814W			Prime + Parallel Group 7-8 in Visit 13	550 Secs [==>]	[1]
	9	M31-B11-F 13-IR-f160 w	(37) M31-B11-F13-IR R	WFC3/IR, MULTIACCUM, IR-FIX	F160W	NSAMP=9; SAMP-SEQ=STEP200	POS TARG 0,0	Prime + Parallel Group 9-10 in Visit 13	[==>]	[2]
	10	M31-B11-F 16-WFC-F4 75W-short	(39) M31-B11-F16-WFC	ACS/WFC, ACCUM, WFC	F475W			Prime + Parallel Group 9-10 in Visit 13	10 Secs [==>]	[2]
	11	M31-B11-F 13-IR-f110 w	(37) M31-B11-F13-IR R	WFC3/IR, MULTIACCUM, IR-FIX	F110W	NSAMP=11; SAMP-SEQ=STEP200	POS TARG 0.187,0.086	Prime + Parallel Group 11-12 in Visit 13	[==>]	[2]
	12	M31-B11-F 16-WFC-F4 75W	(39) M31-B11-F16-WFC	ACS/WFC, ACCUM, WFC	F475W			Prime + Parallel Group 11-12 in Visit 13	700 Secs [==>]	[2]
	13	M31-B11-F 13-IR-f160 w	(37) M31-B11-F13-IR R	WFC3/IR, MULTIACCUM, IR-FIX	F160W	NSAMP=9; SAMP-SEQ=STEP200	POS TARG 0.206,0.171	Prime + Parallel Group 13-14 in Visit 13	[==>]	[2]
	14	M31-B11-F 16-WFC-F4 75W	(39) M31-B11-F16-WFC	ACS/WFC, ACCUM, WFC	F475W			Prime + Parallel Group 13-14 in Visit 13	360 Secs [==>]	[2]
	15	M31-B11-F 13-IR-f160 w	(37) M31-B11-F13-IR R	WFC3/IR, MULTIACCUM, IR-FIX	F160W	NSAMP=9; SAMP-SEQ=STEP200	POS TARG 0.263,0.188	Prime + Parallel Group 15-16 in Visit 13	[==>]	[2]
	16	M31-B11-F 16-WFC-F4 75W	(39) M31-B11-F16-WFC	ACS/WFC, ACCUM, WFC	F475W			Prime + Parallel Group 15-16 in Visit 13	360 Secs [==>]	[2]
	17	M31-B11-F 13-IR-f160 w	(37) M31-B11-F13-IR R	WFC3/IR, MULTIACCUM, IR-FIX	F160W	NSAMP=11; SAMP-SEQ=STEP100	POS TARG 0.204,-0.001	Prime + Parallel Group 17-18 in Visit 13	[==>]	[2]
	18	M31-B11-F 16-WFC-F4 75W	(39) M31-B11-F16-WFC	ACS/WFC, ACCUM, WFC	F475W			Prime + Parallel Group 17-18 in Visit 13	470 Secs [==>]	[2]

Orbit 1

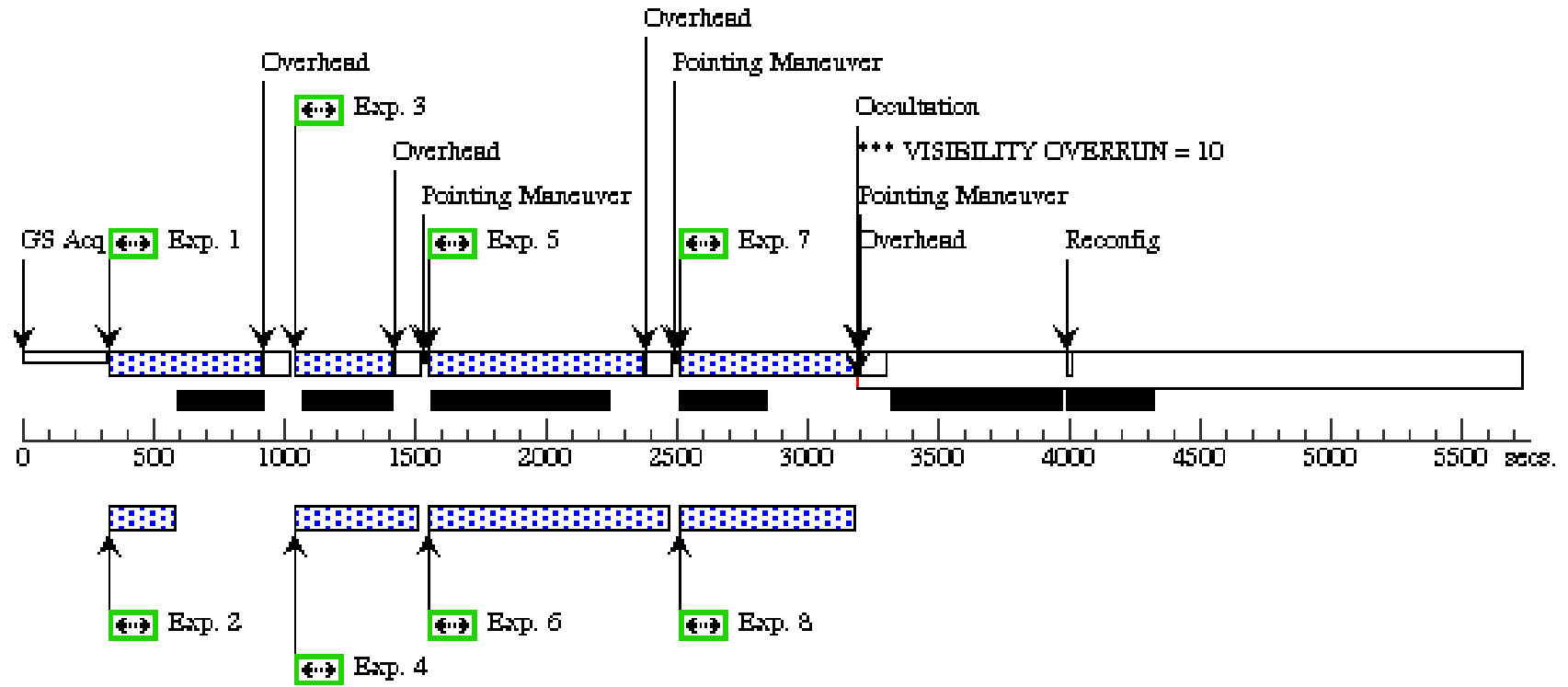

Orbit Structure

Orbit 2

Server Version: 20120604

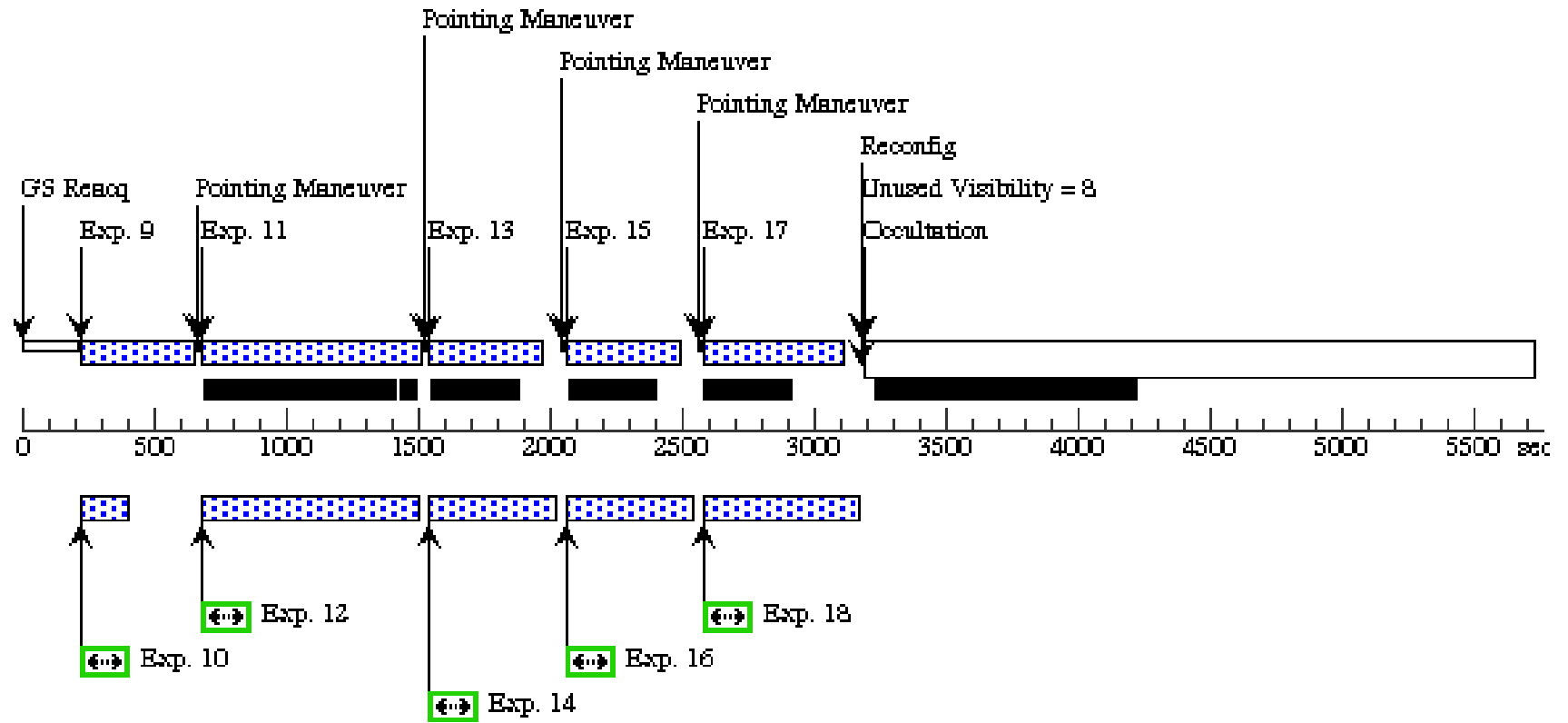

Proposal 12115 - Visit 14 - A Panchromatic Hubble Andromeda Treasury - I

Fri Jun 08 01:09:32 GMT 2012

Visit	<p>Proposal 12115, Visit 14, withdrawn</p> <p>Diagnostic Status: Warning</p> <p>Scientific Instruments: WFC3/IR, WFC3/UVIS, ACS/WFC</p> <p>Special Requirements: SCHED 60%: ORIENT 54D TO 54 D</p>					
Diagnostics	<p>(Visit 14) Warning (Orbit Planner): VISIBILITY OVERRUN</p> <p>(Visit 14) Warning (Orbit Planner): PARALLELS SIGNIFICANTLY EXTEND ALIGNMENT TIME</p> <p>(Visit 14) Warning (Form): The 'SCHED=100' special requirement must be selected for this visit.</p>					
Fixed Targets	#	Name	Target Coordinates	Targ. Coord. Corrections	Fluxes	Miscellaneous
	(40)	M31-B11-F14-IR	RA: 00 44 48.4750 (11.2019792d) Dec: +41 37 33.36 (41.62593d) Equinox: J2000		V=20+/-0.1	Reference Frame: ICRS
	(41)	M31-B11-F14-UVIS	RA: 00 44 48.4750 (11.2019792d) Dec: +41 37 33.36 (41.62593d) Equinox: J2000		V=20+/-0.1	Reference Frame: ICRS
	(42)	M31-B11-F17-WFC	RA: 00 44 48.4750 (11.2019792d) Dec: +41 37 33.36 (41.62593d) Equinox: J2000		V=20+/-0.1	Reference Frame: ICRS

Proposal 12115 - Visit 14 - A Panchromatic Hubble Andromeda Treasury - I

#	Label	Target	Config,Mode,Aperture	Spectral Els.	Opt. Params.	Special Reqs.	Groups	Exp. Time/[Actual Dur.]	Orbit	
Exposures	1	M31-B11-F 14-UVIS-F3 36W	(41) M31-B11-F14- UVIS	WFC3/UVIS, ACCUM, UVIS-CENTER	F336W	CR-SPLIT=NO	POS TARG 1.655,2. 96	Prime + Parallel Gro up 1-2 in Visit 14	550 Secs [==>]	[1]
	2	M31-B11-F 17-WFC-F8 14W-short	(42) M31-B11-F17- WFC	ACS/WFC, ACCUM, WFC	F814W			Prime + Parallel Gro up 1-2 in Visit 14	15 Secs [==>]	[1]
	3	M31-B11-F 14-UVIS-F2 75W	(41) M31-B11-F14- UVIS	WFC3/UVIS, ACCUM, UVIS-CENTER	F275W	CR-SPLIT=NO	POS TARG 1.655,2. 96	Prime + Parallel Gro up 3-4 in Visit 14	350 Secs [==>]	[1]
	4	M31-B11-F 17-WFC-F8 14W	(42) M31-B11-F17- WFC	ACS/WFC, ACCUM, WFC	F814W			Prime + Parallel Gro up 3-4 in Visit 14	350 Secs [==>]	[1]
	5	M31-B11-F 14-UVIS-F3 36W	(41) M31-B11-F14- UVIS	WFC3/UVIS, ACCUM, UVIS-CENTER	F336W	CR-SPLIT=NO	POS TARG 1.634,4. 882	Prime + Parallel Gro up 5-6 in Visit 14	800 Secs [==>]	[1]
	6	M31-B11-F 17-WFC-F8 14W	(42) M31-B11-F17- WFC	ACS/WFC, ACCUM, WFC	F814W			Prime + Parallel Gro up 5-6 in Visit 14	800 Secs [==>]	[1]
	7	M31-B11-F 14-UVIS-F2 75W	(41) M31-B11-F14- UVIS	WFC3/UVIS, ACCUM, UVIS-CENTER	F275W	CR-SPLIT=NO	POS TARG 1.525,4. 882	Prime + Parallel Gro up 7-8 in Visit 14	660 Secs [==>]	[1]
	8	M31-B11-F 17-WFC-F8 14W	(42) M31-B11-F17- WFC	ACS/WFC, ACCUM, WFC	F814W			Prime + Parallel Gro up 7-8 in Visit 14	550 Secs [==>]	[1]
	9	M31-B11-F 14-IR-f160 w	(40) M31-B11-F14-I R	WFC3/IR, MULTIACCUM, IR-FIX	F160W	NSAMP=9; SAMP-SEQ=STEP2 00	POS TARG 0,0	Prime + Parallel Gro up 9-10 in Visit 14	[==>]	[2]
	10	M31-B11-F 17-WFC-F4 75W-short	(42) M31-B11-F17- WFC	ACS/WFC, ACCUM, WFC	F475W			Prime + Parallel Gro up 9-10 in Visit 14	10 Secs [==>]	[2]
	11	M31-B11-F 14-IR-f110 w	(40) M31-B11-F14-I R	WFC3/IR, MULTIACCUM, IR-FIX	F110W	NSAMP=11; SAMP-SEQ=STEP2 00	POS TARG 0.187,0. 086	Prime + Parallel Gro up 11-12 in Visit 14	[==>]	[2]
	12	M31-B11-F 17-WFC-F4 75W	(42) M31-B11-F17- WFC	ACS/WFC, ACCUM, WFC	F475W			Prime + Parallel Gro up 11-12 in Visit 14	700 Secs [==>]	[2]
	13	M31-B11-F 14-IR-f160 w	(40) M31-B11-F14-I R	WFC3/IR, MULTIACCUM, IR-FIX	F160W	NSAMP=9; SAMP-SEQ=STEP2 00	POS TARG 0.206,0. 171	Prime + Parallel Gro up 13-14 in Visit 14	[==>]	[2]
	14	M31-B11-F 17-WFC-F4 75W	(42) M31-B11-F17- WFC	ACS/WFC, ACCUM, WFC	F475W			Prime + Parallel Gro up 13-14 in Visit 14	360 Secs [==>]	[2]
	15	M31-B11-F 14-IR-f160 w	(40) M31-B11-F14-I R	WFC3/IR, MULTIACCUM, IR-FIX	F160W	NSAMP=9; SAMP-SEQ=STEP2 00	POS TARG 0.263,0. 188	Prime + Parallel Gro up 15-16 in Visit 14	[==>]	[2]
	16	M31-B11-F 17-WFC-F4 75W	(42) M31-B11-F17- WFC	ACS/WFC, ACCUM, WFC	F475W			Prime + Parallel Gro up 15-16 in Visit 14	360 Secs [==>]	[2]
	17	M31-B11-F 14-IR-f160 w	(40) M31-B11-F14-I R	WFC3/IR, MULTIACCUM, IR-FIX	F160W	NSAMP=11; SAMP-SEQ=STEP1 00	POS TARG 0.204,-0 .001	Prime + Parallel Gro up 17-18 in Visit 14	[==>]	[2]
	18	M31-B11-F 17-WFC-F4 75W	(42) M31-B11-F17- WFC	ACS/WFC, ACCUM, WFC	F475W			Prime + Parallel Gro up 17-18 in Visit 14	470 Secs [==>]	[2]

Orbit 1

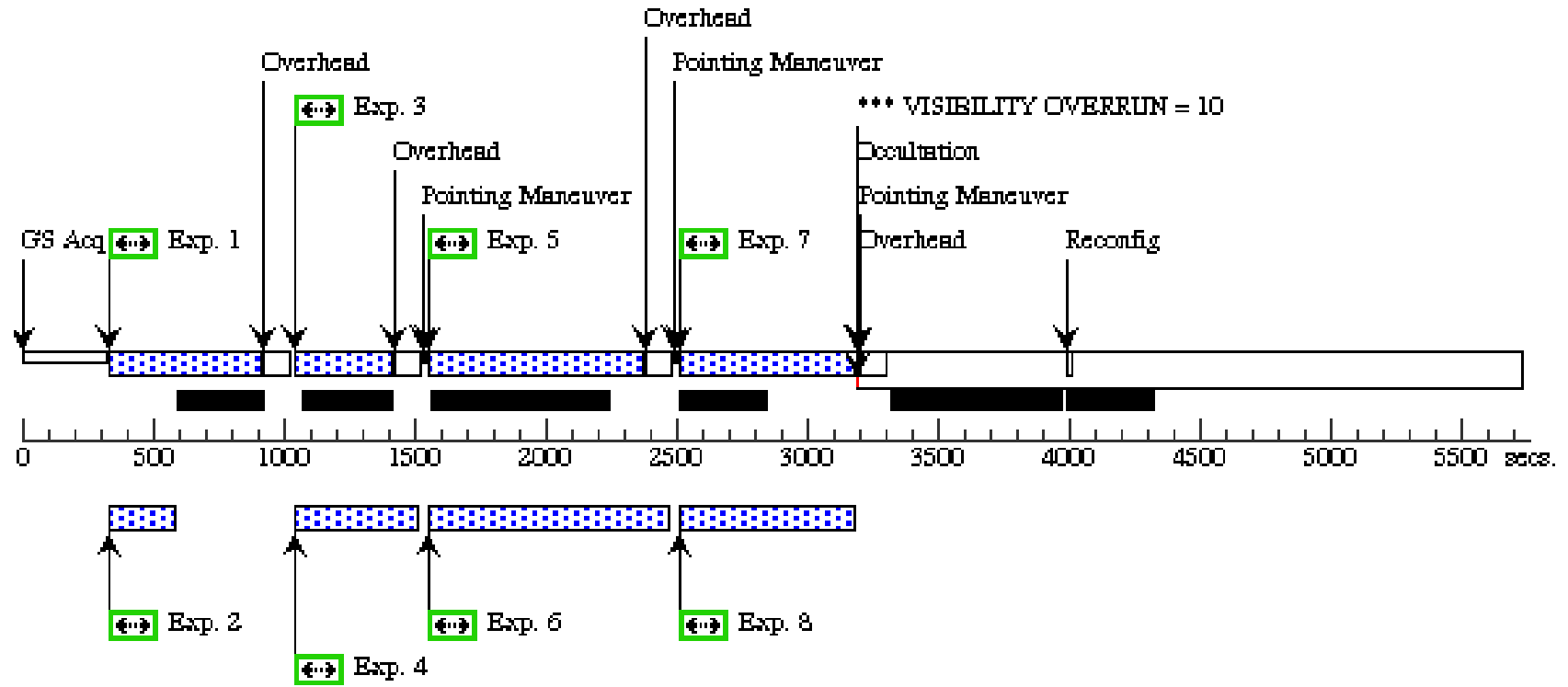

Orbit Structure

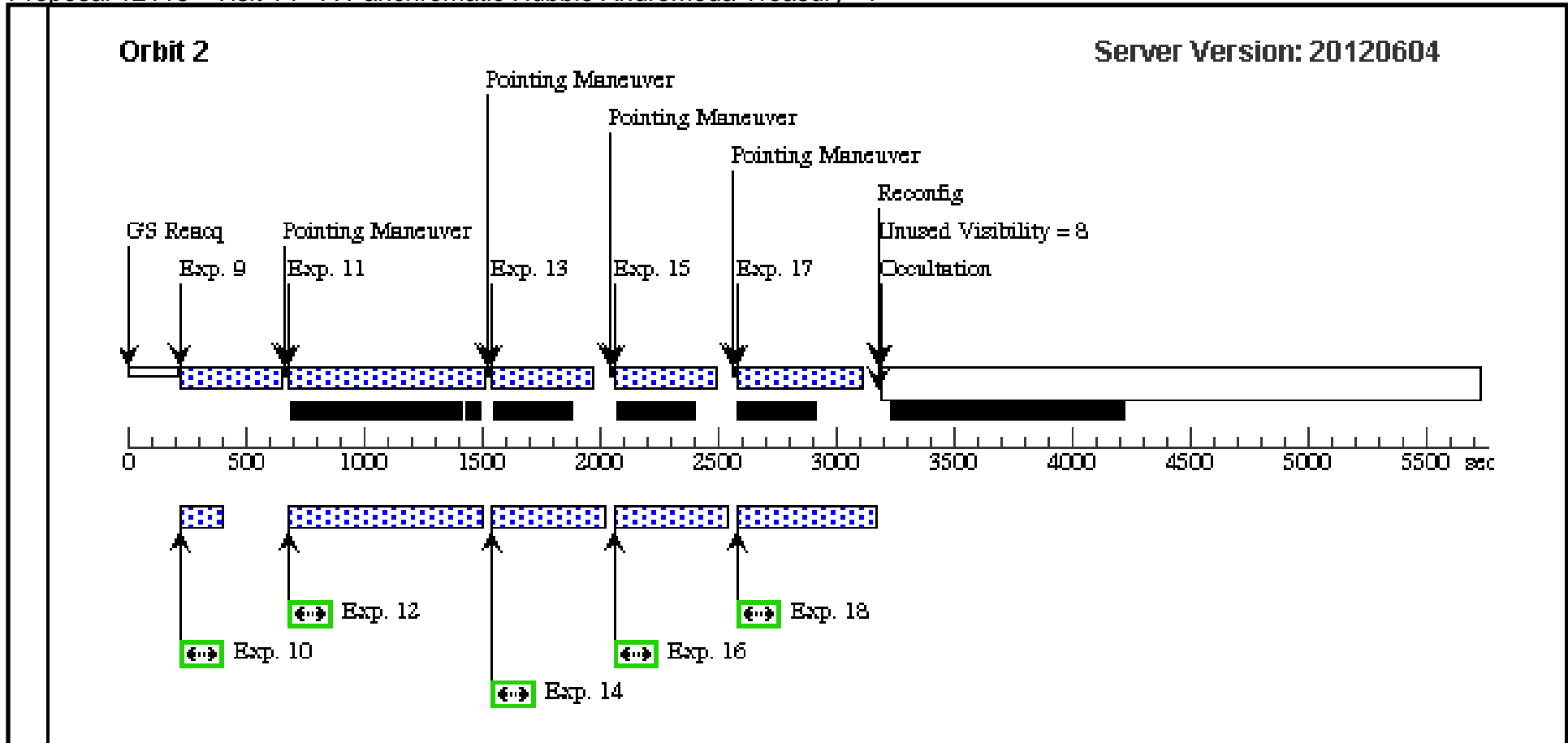

Proposal 12115 - Visit 15 - A Panchromatic Hubble Andromeda Treasury - I

Fri Jun 08 01:09:35 GMT 2012

Visit	<p>Proposal 12115, Visit 15, withdrawn</p> <p>Diagnostic Status: Warning</p> <p>Scientific Instruments: WFC3/IR, WFC3/UVIS, ACS/WFC</p> <p>Special Requirements: SCHED 60%: ORIENT 54D TO 54 D</p>					
Diagnostics	<p>(Visit 15) Warning (Form): The 'SCHED=100' special requirement must be selected for this visit.</p> <p>(Visit 15) Warning (Orbit Planner): VISIBILITY OVERRUN</p> <p>(Visit 15) Warning (Orbit Planner): PARALLELS SIGNIFICANTLY EXTEND ALIGNMENT TIME</p>					
Fixed Targets	#	Name	Target Coordinates	Targ. Coord. Corrections	Fluxes	Miscellaneous
	(43)	M31-B11-F15-IR	RA: 00 44 38.0029 (11.1583454d) Dec: +41 37 51.94 (41.63109d) Equinox: J2000		V=20+/-0.1	Reference Frame: ICRS
	(44)	M31-B11-F15-UVIS	RA: 00 44 38.0029 (11.1583454d) Dec: +41 37 51.94 (41.63109d) Equinox: J2000		V=20+/-0.1	Reference Frame: ICRS
	(45)	M31-B11-F18-WFC	RA: 00 44 38.0029 (11.1583454d) Dec: +41 37 51.94 (41.63109d) Equinox: J2000		V=20+/-0.1	Reference Frame: ICRS

Proposal 12115 - Visit 15 - A Panchromatic Hubble Andromeda Treasury - I

#	Label	Target	Config,Mode,Aperture	Spectral Els.	Opt. Params.	Special Reqs.	Groups	Exp. Time/[Actual Dur.]	Orbit	
Exposures	1	M31-B11-F 15-UVIS-F3 36W	(44) M31-B11-F15- UVIS	WFC3/UVIS, ACCUM, UVIS-CENTER	F336W	CR-SPLIT=NO	POS TARG 1.655,2. 96	Prime + Parallel Gro up 1-2 in Visit 15	550 Secs [==>]	[1]
	2	M31-B11-F 18-WFC-F8 14W-short	(45) M31-B11-F18- WFC	ACS/WFC, ACCUM, WFC	F814W			Prime + Parallel Gro up 1-2 in Visit 15	15 Secs [==>]	[1]
	3	M31-B11-F 15-UVIS-F2 75W	(44) M31-B11-F15- UVIS	WFC3/UVIS, ACCUM, UVIS-CENTER	F275W	CR-SPLIT=NO	POS TARG 1.655,2. 96	Prime + Parallel Gro up 3-4 in Visit 15	350 Secs [==>]	[1]
	4	M31-B11-F 18-WFC-F8 14W	(45) M31-B11-F18- WFC	ACS/WFC, ACCUM, WFC	F814W			Prime + Parallel Gro up 3-4 in Visit 15	350 Secs [==>]	[1]
	5	M31-B11-F 15-UVIS-F3 36W	(44) M31-B11-F15- UVIS	WFC3/UVIS, ACCUM, UVIS-CENTER	F336W	CR-SPLIT=NO	POS TARG 1.634,4. 882	Prime + Parallel Gro up 5-6 in Visit 15	800 Secs [==>]	[1]
	6	M31-B11-F 18-WFC-F8 14W	(45) M31-B11-F18- WFC	ACS/WFC, ACCUM, WFC	F814W			Prime + Parallel Gro up 5-6 in Visit 15	800 Secs [==>]	[1]
	7	M31-B11-F 15-UVIS-F2 75W	(44) M31-B11-F15- UVIS	WFC3/UVIS, ACCUM, UVIS-CENTER	F275W	CR-SPLIT=NO	POS TARG 1.525,4. 882	Prime + Parallel Gro up 7-8 in Visit 15	660 Secs [==>]	[1]
	8	M31-B11-F 18-WFC-F8 14W	(45) M31-B11-F18- WFC	ACS/WFC, ACCUM, WFC	F814W			Prime + Parallel Gro up 7-8 in Visit 15	550 Secs [==>]	[1]
	9	M31-B11-F 15-IR-f160 w	(43) M31-B11-F15-I R	WFC3/IR, MULTIACCUM, IR-FIX	F160W	NSAMP=9; SAMP-SEQ=STEP2 00	POS TARG 0,0	Prime + Parallel Gro up 9-10 in Visit 15	[==>]	[2]
	10	M31-B11-F 18-WFC-F4 75W-short	(45) M31-B11-F18- WFC	ACS/WFC, ACCUM, WFC	F475W			Prime + Parallel Gro up 9-10 in Visit 15	10 Secs [==>]	[2]
	11	M31-B11-F 15-IR-f110 w	(43) M31-B11-F15-I R	WFC3/IR, MULTIACCUM, IR-FIX	F110W	NSAMP=11; SAMP-SEQ=STEP2 00	POS TARG 0.187,0. 086	Prime + Parallel Gro up 11-12 in Visit 15	[==>]	[2]
	12	M31-B11-F 18-WFC-F4 75W	(45) M31-B11-F18- WFC	ACS/WFC, ACCUM, WFC	F475W			Prime + Parallel Gro up 11-12 in Visit 15	700 Secs [==>]	[2]
	13	M31-B11-F 15-IR-f160 w	(43) M31-B11-F15-I R	WFC3/IR, MULTIACCUM, IR-FIX	F160W	NSAMP=9; SAMP-SEQ=STEP2 00	POS TARG 0.206,0. 171	Prime + Parallel Gro up 13-14 in Visit 15	[==>]	[2]
	14	M31-B11-F 18-WFC-F4 75W	(45) M31-B11-F18- WFC	ACS/WFC, ACCUM, WFC	F475W			Prime + Parallel Gro up 13-14 in Visit 15	360 Secs [==>]	[2]
	15	M31-B11-F 15-IR-f160 w	(43) M31-B11-F15-I R	WFC3/IR, MULTIACCUM, IR-FIX	F160W	NSAMP=9; SAMP-SEQ=STEP2 00	POS TARG 0.263,0. 188	Prime + Parallel Gro up 15-16 in Visit 15	[==>]	[2]
	16	M31-B11-F 18-WFC-F4 75W	(45) M31-B11-F18- WFC	ACS/WFC, ACCUM, WFC	F475W			Prime + Parallel Gro up 15-16 in Visit 15	360 Secs [==>]	[2]
	17	M31-B11-F 15-IR-f160 w	(43) M31-B11-F15-I R	WFC3/IR, MULTIACCUM, IR-FIX	F160W	NSAMP=11; SAMP-SEQ=STEP1 00	POS TARG 0.204,-0 .001	Prime + Parallel Gro up 17-18 in Visit 15	[==>]	[2]
	18	M31-B11-F 18-WFC-F4 75W	(45) M31-B11-F18- WFC	ACS/WFC, ACCUM, WFC	F475W			Prime + Parallel Gro up 17-18 in Visit 15	470 Secs [==>]	[2]

Orbit 1

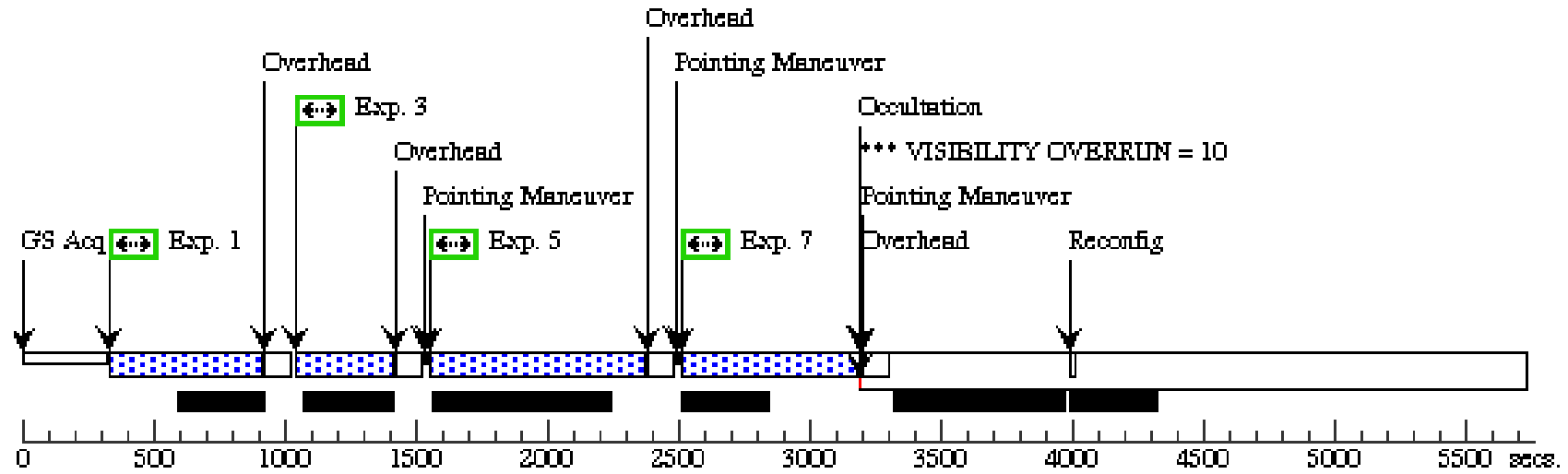

Orbit Structure

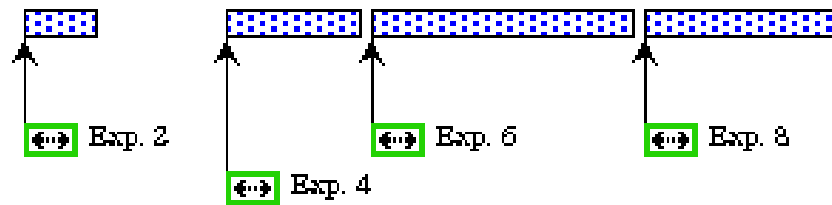

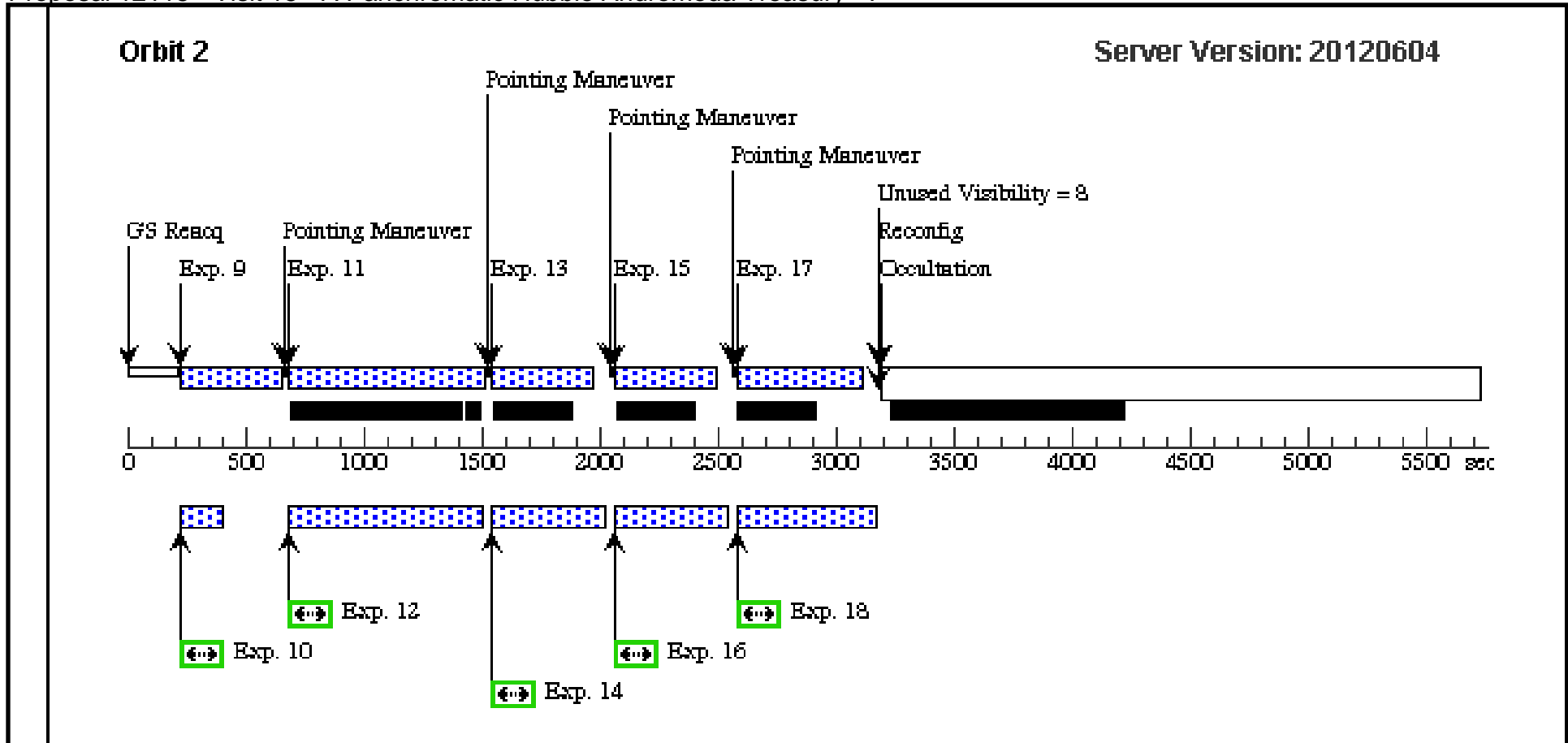

Proposal 12115 - Visit 16 - A Panchromatic Hubble Andromeda Treasury - I

Fri Jun 08 01:09:37 GMT 2012

Visit	Proposal 12115, Visit 16, implementation Diagnostic Status: Warning Scientific Instruments: WFC3/IR, WFC3/UVIS, ACS/WFC Special Requirements: SCHED 100%; ORIENT 234D TO 234 D					
Diagnostics	(Visit 16) Warning (Orbit Planner): PARALLELS SIGNIFICANTLY EXTEND ALIGNMENT TIME					
	(Visit 16) Warning (Orbit Planner): VISIBILITY OVERRUN					
	(Visit 16) Warning (Orbit Planner): PARALLELS SIGNIFICANTLY EXTEND ALIGNMENT TIME					
	(Visit 16) Warning (Orbit Planner): PARALLELS SIGNIFICANTLY EXTEND ALIGNMENT TIME					
Fixed Targets	#	Name	Target Coordinates	Targ. Coord. Corrections	Fluxes	Miscellaneous
	(46)	M31-B11-F16-IR	RA: 00 44 27.3166 (11.1138192d) Dec: +41 38 10.53 (41.63626d) Equinox: J2000		V=20+/-0.1	Reference Frame: ICRS
	(47)	M31-B11-F16-UVIS	RA: 00 44 27.3166 (11.1138192d) Dec: +41 38 10.53 (41.63626d) Equinox: J2000		V=20+/-0.1	Reference Frame: ICRS
	(48)	M31-B11-F13-WFC	RA: 00 44 27.3166 (11.1138192d) Dec: +41 38 10.53 (41.63626d) Equinox: J2000		V=20+/-0.1	Reference Frame: ICRS

Proposal 12115 - Visit 16 - A Panchromatic Hubble Andromeda Treasury - I

#	Label	Target	Config,Mode,Aperture	Spectral Els.	Opt. Params.	Special Reqs.	Groups	Exp. Time/[Actual Dur.]	Orbit	
Exposures	1	M31-B11-F 16-UVIS-F3 36W	(47) M31-B11-F16- UVIS	WFC3/UVIS, ACCUM, UVIS-CENTER	F336W	CR-SPLIT=NO	POS TARG 1.655,2. 96	Prime + Parallel Gro up 1-2 in Visit 16	550 Secs [==>]	[1]
	2	M31-B11-F 13-WFC-F8 14W-short	(48) M31-B11-F13- WFC	ACS/WFC, ACCUM, WFC	F814W			Prime + Parallel Gro up 1-2 in Visit 16	15 Secs [==>]	[1]
	3	M31-B11-F 16-UVIS-F2 75W	(47) M31-B11-F16- UVIS	WFC3/UVIS, ACCUM, UVIS-CENTER	F275W	CR-SPLIT=NO	POS TARG 1.655,2. 96	Prime + Parallel Gro up 3-4 in Visit 16	350 Secs [==>]	[1]
	4	M31-B11-F 13-WFC-F8 14W	(48) M31-B11-F13- WFC	ACS/WFC, ACCUM, WFC	F814W			Prime + Parallel Gro up 3-4 in Visit 16	350 Secs [==>]	[1]
	5	M31-B11-F 16-UVIS-F3 36W	(47) M31-B11-F16- UVIS	WFC3/UVIS, ACCUM, UVIS-CENTER	F336W	CR-SPLIT=NO	POS TARG 1.634,4. 882	Prime + Parallel Gro up 5-6 in Visit 16	700 Secs [==>]	[1]
	6	M31-B11-F 13-WFC-F8 14W	(48) M31-B11-F13- WFC	ACS/WFC, ACCUM, WFC	F814W			Prime + Parallel Gro up 5-6 in Visit 16	700 Secs [==>]	[1]
	7	M31-B11-F 16-UVIS-F2 75W	(47) M31-B11-F16- UVIS	WFC3/UVIS, ACCUM, UVIS-CENTER	F275W	CR-SPLIT=NO	POS TARG 1.525,4. 882	Prime + Parallel Gro up 7-8 in Visit 16	575 Secs [==>]	[1]
	8	M31-B11-F 13-WFC-F8 14W	(48) M31-B11-F13- WFC	ACS/WFC, ACCUM, WFC	F814W			Prime + Parallel Gro up 7-8 in Visit 16	455 Secs [==>]	[1]
	9	M31-B11-F 16-IR-f160 w	(46) M31-B11-F16-1 R	WFC3/IR, MULTIACCUM, IR-FIX	F160W	NSAMP=9; SAMP-SEQ=STEP2 00	POS TARG 0,0	Prime + Parallel Gro up 9-10 in Visit 16	[==>]	[2]
	10	M31-B11-F 13-WFC-F4 75W-short	(48) M31-B11-F13- WFC	ACS/WFC, ACCUM, WFC	F475W			Prime + Parallel Gro up 9-10 in Visit 16	10 Secs [==>]	[2]
	11	M31-B11-F 16-IR-f110 w	(46) M31-B11-F16-1 R	WFC3/IR, MULTIACCUM, IR-FIX	F110W	NSAMP=13; SAMP-SEQ=STEP1 00	POS TARG 0.187,0. 086	Prime + Parallel Gro up 11-12 in Visit 16	[==>]	[2]
	12	M31-B11-F 13-WFC-F4 75W	(48) M31-B11-F13- WFC	ACS/WFC, ACCUM, WFC	F475W			Prime + Parallel Gro up 11-12 in Visit 16	600 Secs [==>]	[2]
	13	M31-B11-F 16-IR-f160 w	(46) M31-B11-F16-1 R	WFC3/IR, MULTIACCUM, IR-FIX	F160W	NSAMP=9; SAMP-SEQ=STEP2 00	POS TARG 0.206,0. 171	Prime + Parallel Gro up 13-14 in Visit 16	[==>]	[2]
	14	M31-B11-F 13-WFC-F4 75W	(48) M31-B11-F13- WFC	ACS/WFC, ACCUM, WFC	F475W			Prime + Parallel Gro up 13-14 in Visit 16	370 Secs [==>]	[2]
	15	M31-B11-F 16-IR-f160 w	(46) M31-B11-F16-1 R	WFC3/IR, MULTIACCUM, IR-FIX	F160W	NSAMP=9; SAMP-SEQ=STEP2 00	POS TARG 0.263,0. 188	Prime + Parallel Gro up 15-16 in Visit 16	[==>]	[2]
	16	M31-B11-F 13-WFC-F4 75W	(48) M31-B11-F13- WFC	ACS/WFC, ACCUM, WFC	F475W			Prime + Parallel Gro up 15-16 in Visit 16	370 Secs [==>]	[2]
	17	M31-B11-F 16-IR-f160 w	(46) M31-B11-F16-1 R	WFC3/IR, MULTIACCUM, IR-FIX	F160W	NSAMP=9; SAMP-SEQ=STEP2 00	POS TARG 0.204,-0 .001	Prime + Parallel Gro up 17-18 in Visit 16	[==>]	[2]
	18	M31-B11-F 13-WFC-F4 75W	(48) M31-B11-F13- WFC	ACS/WFC, ACCUM, WFC	F475W			Prime + Parallel Gro up 17-18 in Visit 16	370 Secs [==>]	[2]

Orbit 1

Orbit Structure

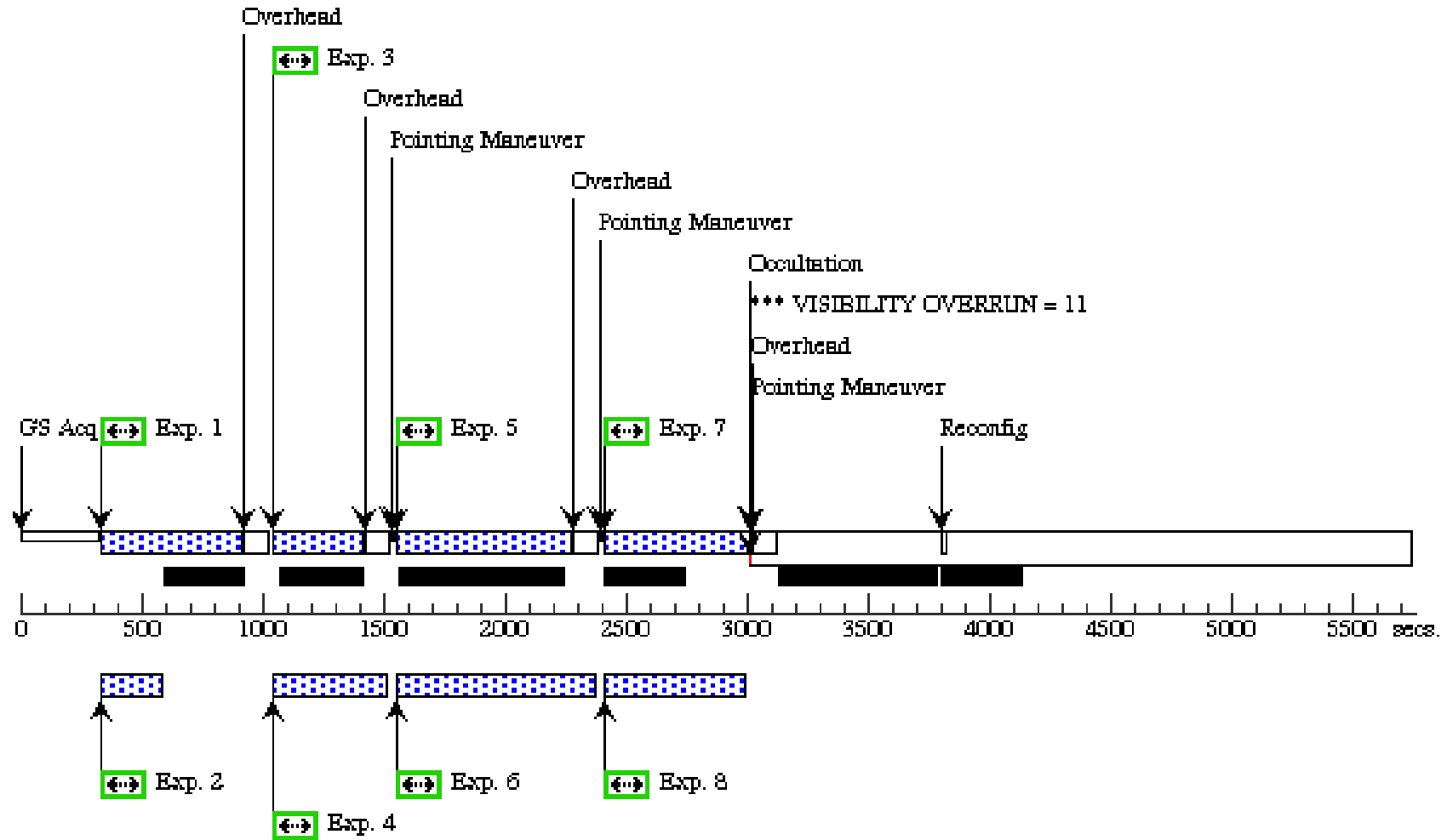

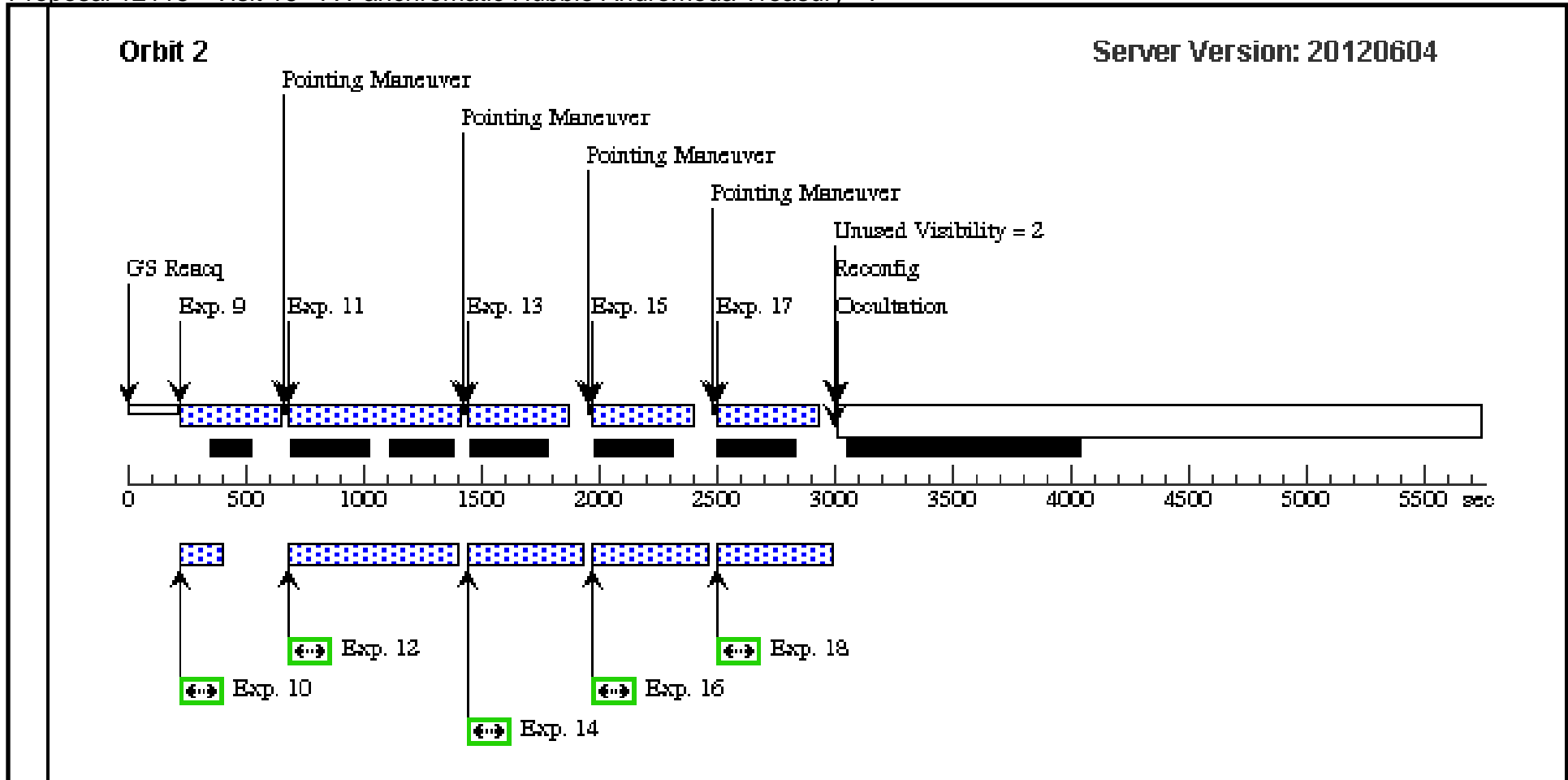

Proposal 12115 - Visit 17 - A Panchromatic Hubble Andromeda Treasury - I

Fri Jun 08 01:09:40 GMT 2012

Visit	Proposal 12115, Visit 17, implementation Diagnostic Status: Warning Scientific Instruments: WFC3/IR, WFC3/UVIS, ACS/WFC Special Requirements: SCHED 100%; ORIENT 234D TO 234 D					
Diagnostics	(Visit 17) Warning (Orbit Planner): VISIBILITY OVERRUN (Visit 17) Warning (Orbit Planner): PARALLELS SIGNIFICANTLY EXTEND ALIGNMENT TIME (Visit 17) Warning (Orbit Planner): PARALLELS SIGNIFICANTLY EXTEND ALIGNMENT TIME (Visit 17) Warning (Orbit Planner): PARALLELS SIGNIFICANTLY EXTEND ALIGNMENT TIME					
Fixed Targets	#	Name	Target Coordinates	Targ. Coord. Corrections	Fluxes	Miscellaneous
	(49)	M31-B11-F17-IR	RA: 00 44 16.8445 (11.0701854d) Dec: +41 38 29.11 (41.64142d) Equinox: J2000		V=20+/-0.1	Reference Frame: ICRS
	(50)	M31-B11-F17-UVIS	RA: 00 44 16.8445 (11.0701854d) Dec: +41 38 29.11 (41.64142d) Equinox: J2000		V=20+/-0.1	Reference Frame: ICRS
	(51)	M31-B11-F14-WFC	RA: 00 44 16.8445 (11.0701854d) Dec: +41 38 29.11 (41.64142d) Equinox: J2000		V=20+/-0.1	Reference Frame: ICRS

Proposal 12115 - Visit 17 - A Panchromatic Hubble Andromeda Treasury - I

#	Label	Target	Config,Mode,Aperture	Spectral Els.	Opt. Params.	Special Reqs.	Groups	Exp. Time/[Actual Dur.]	Orbit	
Exposures	1	M31-B11-F (50) M31-B11-F17-UVIS-F3 36W	UVIS	WFC3/UVIS, ACCUM, UVIS-CENTER	F336W	CR-SPLIT=NO	POS TARG 1.655,2.96	Prime + Parallel Group 1-2 in Visit 17	550 Secs [==>]	[1]
	2	M31-B11-F (51) M31-B11-F14-WFC-F8 14W-short	WFC	ACS/WFC, ACCUM, WFC	F814W			Prime + Parallel Group 1-2 in Visit 17	15 Secs [==>]	[1]
	3	M31-B11-F (50) M31-B11-F17-UVIS-F2 75W	UVIS	WFC3/UVIS, ACCUM, UVIS-CENTER	F275W	CR-SPLIT=NO	POS TARG 1.655,2.96	Prime + Parallel Group 3-4 in Visit 17	350 Secs [==>]	[1]
	4	M31-B11-F (51) M31-B11-F14-WFC-F8 14W	WFC	ACS/WFC, ACCUM, WFC	F814W			Prime + Parallel Group 3-4 in Visit 17	350 Secs [==>]	[1]
	5	M31-B11-F (50) M31-B11-F17-UVIS-F3 36W	UVIS	WFC3/UVIS, ACCUM, UVIS-CENTER	F336W	CR-SPLIT=NO	POS TARG 1.634,4.882	Prime + Parallel Group 5-6 in Visit 17	700 Secs [==>]	[1]
	6	M31-B11-F (51) M31-B11-F14-WFC-F8 14W	WFC	ACS/WFC, ACCUM, WFC	F814W			Prime + Parallel Group 5-6 in Visit 17	700 Secs [==>]	[1]
	7	M31-B11-F (50) M31-B11-F17-UVIS-F2 75W	UVIS	WFC3/UVIS, ACCUM, UVIS-CENTER	F275W	CR-SPLIT=NO	POS TARG 1.525,4.882	Prime + Parallel Group 7-8 in Visit 17	575 Secs [==>]	[1]
	8	M31-B11-F (51) M31-B11-F14-WFC-F8 14W	WFC	ACS/WFC, ACCUM, WFC	F814W			Prime + Parallel Group 7-8 in Visit 17	455 Secs [==>]	[1]
	9	M31-B11-F (49) M31-B11-F17-IR-f160 w	R	WFC3/IR, MULTIACCUM, IR-FIX	F160W	NSAMP=9; SAMP-SEQ=STEP200	POS TARG 0,0	Prime + Parallel Group 9-10 in Visit 17	[==>]	[2]
	10	M31-B11-F (51) M31-B11-F14-WFC-F4 75W-short	WFC	ACS/WFC, ACCUM, WFC	F475W			Prime + Parallel Group 9-10 in Visit 17	10 Secs [==>]	[2]
	11	M31-B11-F (49) M31-B11-F17-IR-f110 w	R	WFC3/IR, MULTIACCUM, IR-FIX	F110W	NSAMP=13; SAMP-SEQ=STEP100	POS TARG 0.187,0.086	Prime + Parallel Group 11-12 in Visit 17	[==>]	[2]
	12	M31-B11-F (51) M31-B11-F14-WFC-F4 75W	WFC	ACS/WFC, ACCUM, WFC	F475W			Prime + Parallel Group 11-12 in Visit 17	600 Secs [==>]	[2]
	13	M31-B11-F (49) M31-B11-F17-IR-f160 w	R	WFC3/IR, MULTIACCUM, IR-FIX	F160W	NSAMP=9; SAMP-SEQ=STEP200	POS TARG 0.206,0.171	Prime + Parallel Group 13-14 in Visit 17	[==>]	[2]
	14	M31-B11-F (51) M31-B11-F14-WFC-F4 75W	WFC	ACS/WFC, ACCUM, WFC	F475W			Prime + Parallel Group 13-14 in Visit 17	370 Secs [==>]	[2]
	15	M31-B11-F (49) M31-B11-F17-IR-f160 w	R	WFC3/IR, MULTIACCUM, IR-FIX	F160W	NSAMP=9; SAMP-SEQ=STEP200	POS TARG 0.263,0.188	Prime + Parallel Group 15-16 in Visit 17	[==>]	[2]
	16	M31-B11-F (51) M31-B11-F14-WFC-F4 75W	WFC	ACS/WFC, ACCUM, WFC	F475W			Prime + Parallel Group 15-16 in Visit 17	370 Secs [==>]	[2]
	17	M31-B11-F (49) M31-B11-F17-IR-f160 w	R	WFC3/IR, MULTIACCUM, IR-FIX	F160W	NSAMP=9; SAMP-SEQ=STEP200	POS TARG 0.204,-0.001	Prime + Parallel Group 17-18 in Visit 17	[==>]	[2]
	18	M31-B11-F (51) M31-B11-F14-WFC-F4 75W	WFC	ACS/WFC, ACCUM, WFC	F475W			Prime + Parallel Group 17-18 in Visit 17	370 Secs [==>]	[2]

Orbit 1

Orbit Structure

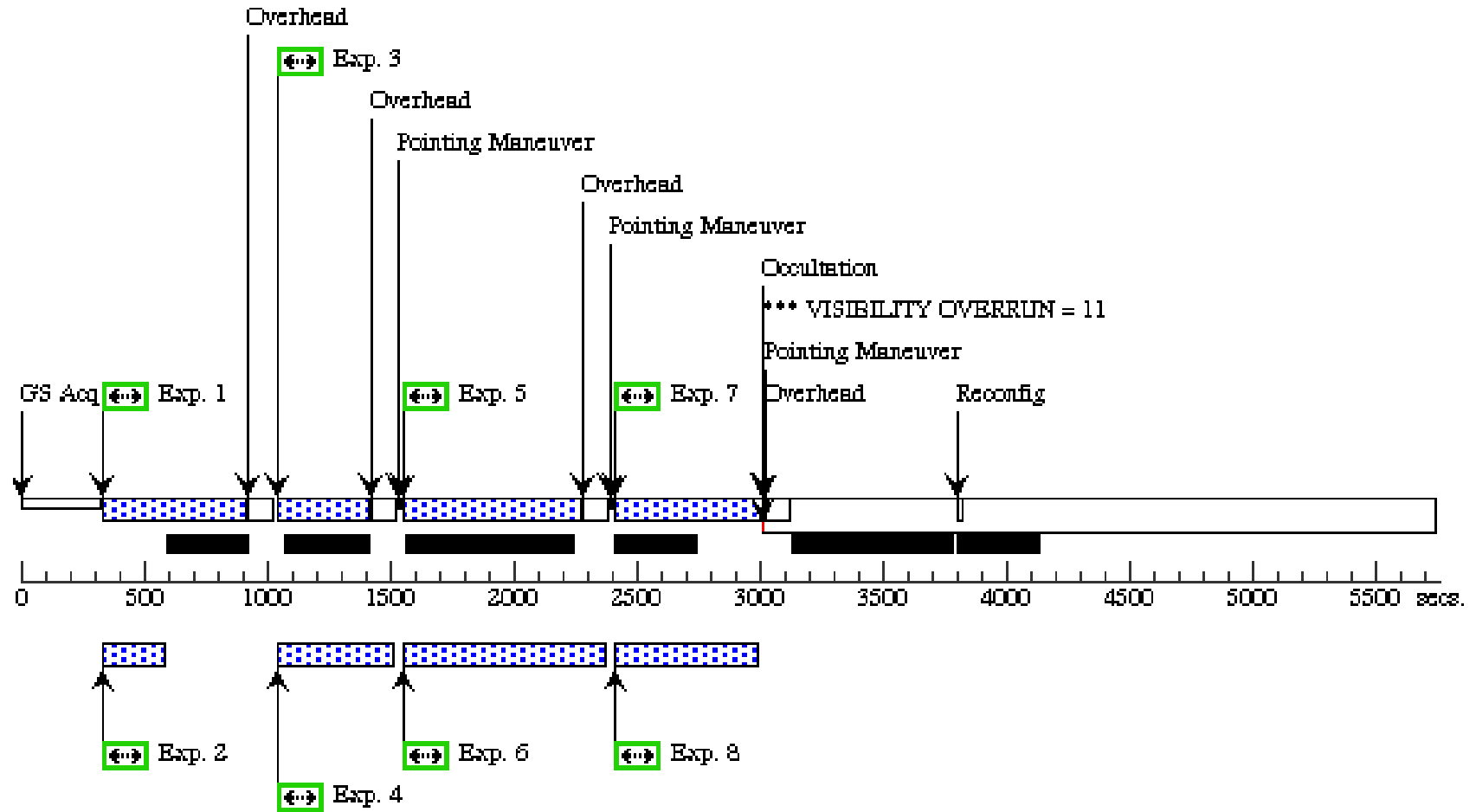

Orbit 2

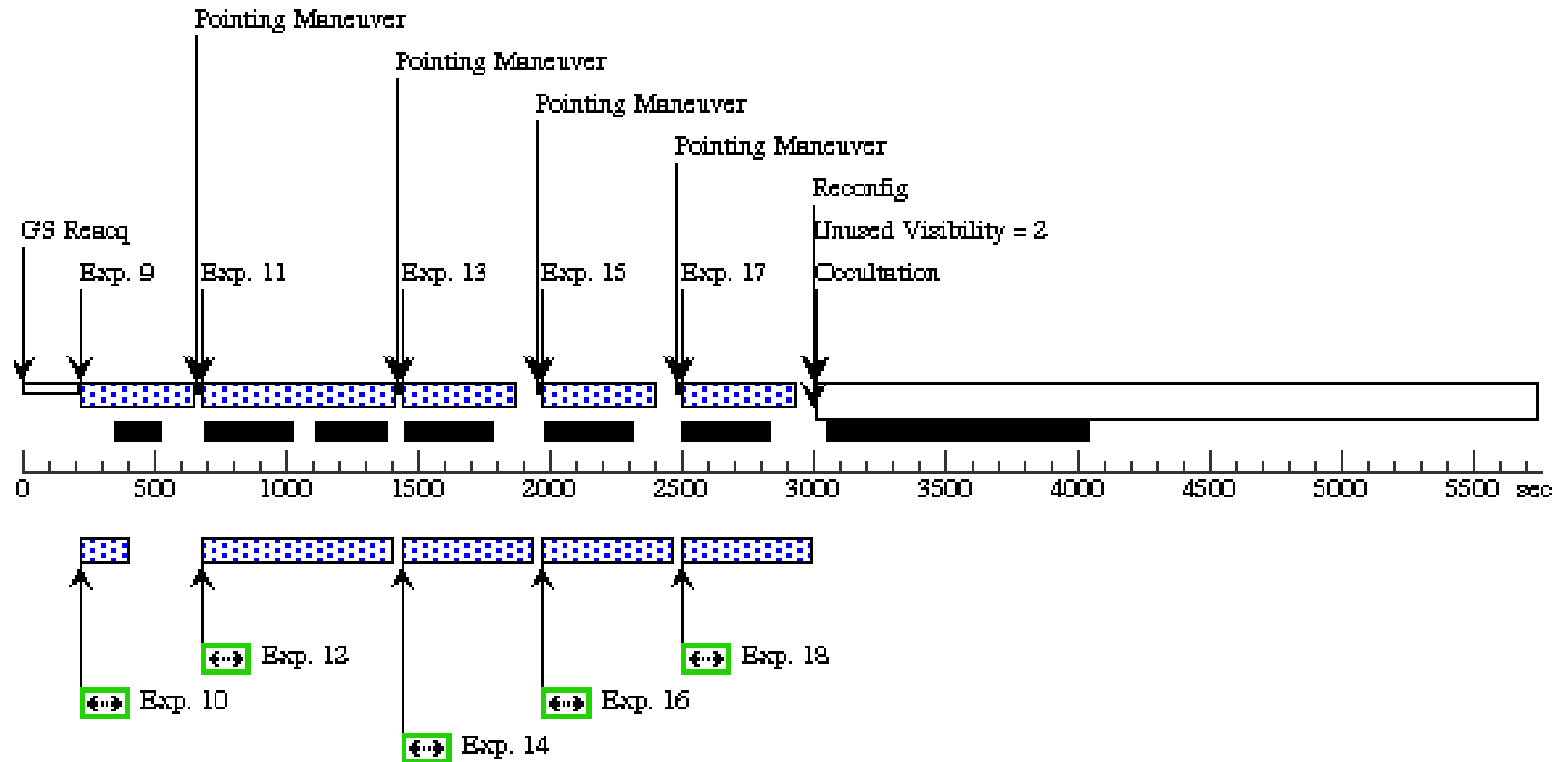

Proposal 12115 - Visit 18 - A Panchromatic Hubble Andromeda Treasury - I

Fri Jun 08 01:09:43 GMT 2012

Visit	Proposal 12115, Visit 18, implementation Diagnostic Status: Warning Scientific Instruments: WFC3/IR, WFC3/UVIS, ACS/WFC Special Requirements: SCHED 100%; ORIENT 234D TO 234 D					
Diagnostics	(Visit 18) Warning (Orbit Planner): PARALLELS SIGNIFICANTLY EXTEND ALIGNMENT TIME (Visit 18) Warning (Orbit Planner): PARALLELS SIGNIFICANTLY EXTEND ALIGNMENT TIME (Visit 18) Warning (Orbit Planner): VISIBILITY OVERRUN (Visit 18) Warning (Orbit Planner): PARALLELS SIGNIFICANTLY EXTEND ALIGNMENT TIME					
Fixed Targets	#	Name	Target Coordinates	Targ. Coord. Corrections	Fluxes	Miscellaneous
	(52)	M31-B11-F18-IR	RA: 00 44 6.3723 (11.0265512d) Dec: +41 38 47.70 (41.64658d) Equinox: J2000		V=20+/-0.1	Reference Frame: ICRS
	(53)	M31-B11-F18-UVIS	RA: 00 44 6.3723 (11.0265512d) Dec: +41 38 47.70 (41.64658d) Equinox: J2000		V=20+/-0.1	Reference Frame: ICRS
	(54)	M31-B11-F15-WFC	RA: 00 44 6.3723 (11.0265512d) Dec: +41 38 47.70 (41.64658d) Equinox: J2000		V=20+/-0.1	Reference Frame: ICRS

Proposal 12115 - Visit 18 - A Panchromatic Hubble Andromeda Treasury - I

#	Label	Target	Config,Mode,Aperture	Spectral Els.	Opt. Params.	Special Reqs.	Groups	Exp. Time/[Actual Dur.]	Orbit	
Exposures	1	M31-B11-F18-UVIS-F3 36W	(53) M31-B11-F18-UVIS	WFC3/UVIS, ACCUM, UVIS-CENTER	F336W	CR-SPLIT=NO	POS TARG 1.655,2.96	Prime + Parallel Group 1-2 in Visit 18	550 Secs [==>]	[1]
	2	M31-B11-F15-WFC-F8 14W-short	(54) M31-B11-F15-WFC	ACS/WFC, ACCUM, WFC	F814W			Prime + Parallel Group 1-2 in Visit 18	15 Secs [==>]	[1]
	3	M31-B11-F18-UVIS-F2 75W	(53) M31-B11-F18-UVIS	WFC3/UVIS, ACCUM, UVIS-CENTER	F275W	CR-SPLIT=NO	POS TARG 1.655,2.96	Prime + Parallel Group 3-4 in Visit 18	350 Secs [==>]	[1]
	4	M31-B11-F15-WFC-F8 14W	(54) M31-B11-F15-WFC	ACS/WFC, ACCUM, WFC	F814W			Prime + Parallel Group 3-4 in Visit 18	350 Secs [==>]	[1]
	5	M31-B11-F18-UVIS-F3 36W	(53) M31-B11-F18-UVIS	WFC3/UVIS, ACCUM, UVIS-CENTER	F336W	CR-SPLIT=NO	POS TARG 1.634,4.882	Prime + Parallel Group 5-6 in Visit 18	700 Secs [==>]	[1]
	6	M31-B11-F15-WFC-F8 14W	(54) M31-B11-F15-WFC	ACS/WFC, ACCUM, WFC	F814W			Prime + Parallel Group 5-6 in Visit 18	700 Secs [==>]	[1]
	7	M31-B11-F18-UVIS-F2 75W	(53) M31-B11-F18-UVIS	WFC3/UVIS, ACCUM, UVIS-CENTER	F275W	CR-SPLIT=NO	POS TARG 1.525,4.882	Prime + Parallel Group 7-8 in Visit 18	575 Secs [==>]	[1]
	8	M31-B11-F15-WFC-F8 14W	(54) M31-B11-F15-WFC	ACS/WFC, ACCUM, WFC	F814W			Prime + Parallel Group 7-8 in Visit 18	455 Secs [==>]	[1]
	9	M31-B11-F18-IR-f160w	(52) M31-B11-F18-IR	WFC3/IR, MULTIACCUM, IR-FIX	F160W	NSAMP=9; SAMP-SEQ=STEP200	POS TARG 0,0	Prime + Parallel Group 9-10 in Visit 18	[==>]	[2]
	10	M31-B11-F15-WFC-F4 75W-short	(54) M31-B11-F15-WFC	ACS/WFC, ACCUM, WFC	F475W			Prime + Parallel Group 9-10 in Visit 18	10 Secs [==>]	[2]
	11	M31-B11-F18-IR-f110w	(52) M31-B11-F18-IR	WFC3/IR, MULTIACCUM, IR-FIX	F110W	NSAMP=13; SAMP-SEQ=STEP100	POS TARG 0.187,0.086	Prime + Parallel Group 11-12 in Visit 18	[==>]	[2]
	12	M31-B11-F15-WFC-F4 75W	(54) M31-B11-F15-WFC	ACS/WFC, ACCUM, WFC	F475W			Prime + Parallel Group 11-12 in Visit 18	600 Secs [==>]	[2]
	13	M31-B11-F18-IR-f160w	(52) M31-B11-F18-IR	WFC3/IR, MULTIACCUM, IR-FIX	F160W	NSAMP=9; SAMP-SEQ=STEP200	POS TARG 0.206,0.171	Prime + Parallel Group 13-14 in Visit 18	[==>]	[2]
	14	M31-B11-F15-WFC-F4 75W	(54) M31-B11-F15-WFC	ACS/WFC, ACCUM, WFC	F475W			Prime + Parallel Group 13-14 in Visit 18	370 Secs [==>]	[2]
	15	M31-B11-F18-IR-f160w	(52) M31-B11-F18-IR	WFC3/IR, MULTIACCUM, IR-FIX	F160W	NSAMP=9; SAMP-SEQ=STEP200	POS TARG 0.263,0.188	Prime + Parallel Group 15-16 in Visit 18	[==>]	[2]
	16	M31-B11-F15-WFC-F4 75W	(54) M31-B11-F15-WFC	ACS/WFC, ACCUM, WFC	F475W			Prime + Parallel Group 15-16 in Visit 18	370 Secs [==>]	[2]
	17	M31-B11-F18-IR-f160w	(52) M31-B11-F18-IR	WFC3/IR, MULTIACCUM, IR-FIX	F160W	NSAMP=9; SAMP-SEQ=STEP200	POS TARG 0.204,-0.001	Prime + Parallel Group 17-18 in Visit 18	[==>]	[2]
	18	M31-B11-F15-WFC-F4 75W	(54) M31-B11-F15-WFC	ACS/WFC, ACCUM, WFC	F475W			Prime + Parallel Group 17-18 in Visit 18	370 Secs [==>]	[2]

Orbit 1

Server Version: 20120604

Orbit Structure

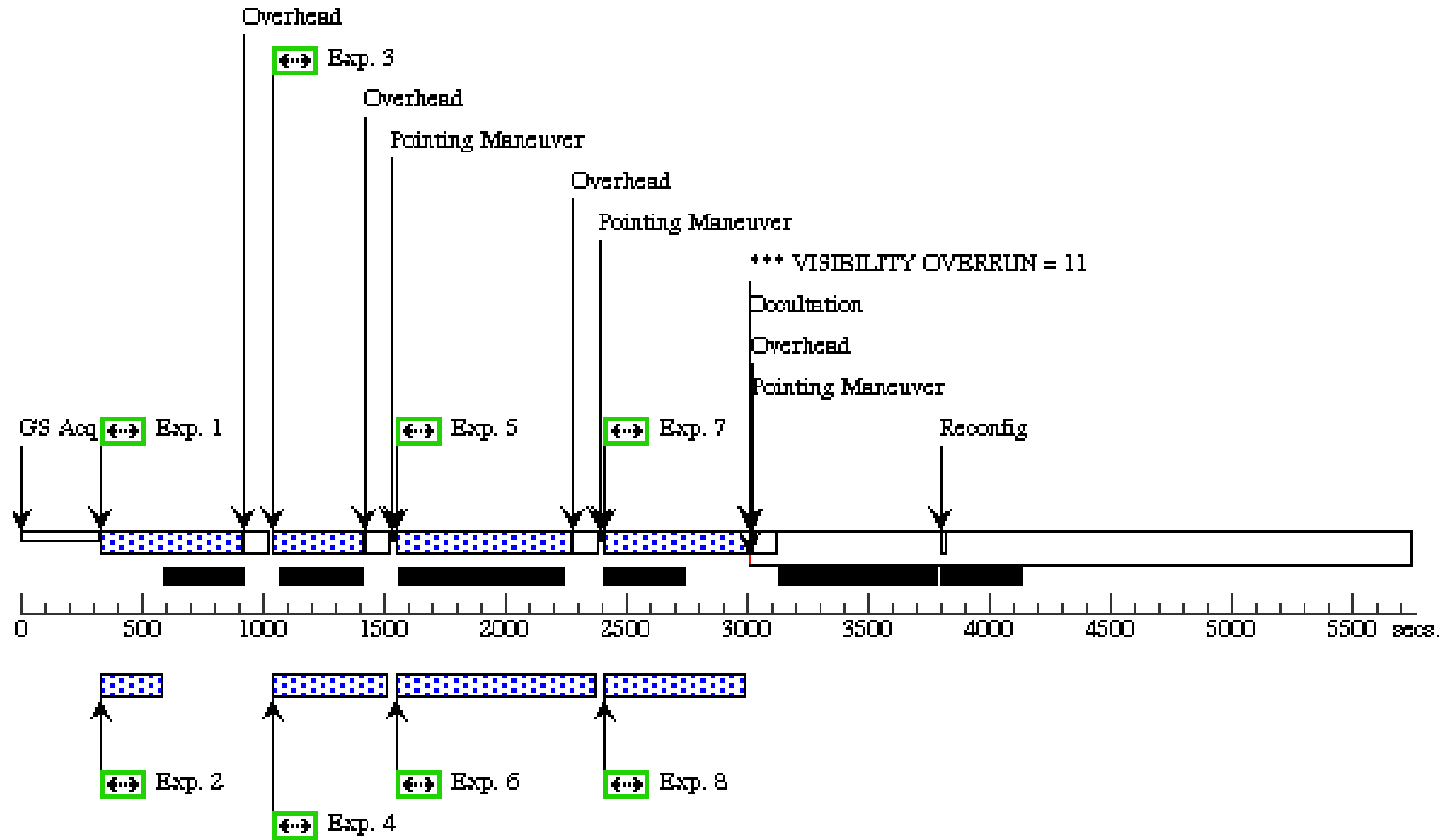

Orbit 2

Server Version: 20120604

