



12459 - Through a Lens, Darkly - New Constraints on the Fundamental Components of the Cosmos

Cycle: 19, Proposal Category: GO

(Treasury)

(Availability Mode: SUPPORTED)

INVESTIGATORS

<i>Name</i>	<i>Institution</i>	<i>E-Mail</i>
Dr. Marc Postman (PI) (Contact)	Space Telescope Science Institute	postman@stsci.edu
Dr. Matthias Bartelmann (CoI) (ESA Member)	Universitat Heidelberg	mbartelmann@ita.uni-heidelberg.de
Dr. Narciso Benitez (CoI) (ESA Member)	Instituto de Astrofisica de Andalucia (IAA)	txitxo@pha.jhu.edu
Dr. Rycharde Bouwens (CoI) (ESA Member)	Universiteit Leiden	bouwens@strw.leidenuniv.nl
Dr. Larry Bradley (CoI)	Space Telescope Science Institute	lbradley@stsci.edu
Dr. Thomas J. Broadhurst (CoI)	Tel Aviv University - Wise Observatory	tjb@wise.tau.ac.il
Dr. Dan Coe (CoI)	Space Telescope Science Institute	dcoe@stsci.edu
Dr. Megan Donahue (CoI)	Michigan State University	donahue@pa.msu.edu
Dr. Rosa M. Gonzalez-Delgado (CoI) (ESA Member)	Instituto de Astrofisica de Andalucia (IAA)	rosa@iaa.es
Dr. Holland Ford (CoI)	The Johns Hopkins University	ford@pha.jhu.edu
Dr. Leopoldo Infante (CoI)	Pontificia Universidad Catolica de Chile	linfante@astro.puc.cl
Dr. Daniel D. Kelson (CoI)	Carnegie Institution of Washington	kelson@obs.carnegiescience.edu
Dr. Anton M. Koekemoer (CoI)	Space Telescope Science Institute	koekemoe@stsci.edu
Dr. Ofer Lahav (CoI) (ESA Member)	University College London	lahav@star.ucl.ac.uk
Prof. Dan Maoz (CoI)	Tel Aviv University - Wise Observatory	dani@wise.tau.ac.il
Ms. Elinor Medezinski (CoI)	Tel Aviv University - Wise Observatory	elinor@wise.tau.ac.il
Dr. Leonidas Moustakas (CoI)	Jet Propulsion Laboratory	leonidas@jpl.nasa.gov
Dr. Enikoe Regoes (CoI) (ESA Member)	European Laboratory for Particle Physics (CERN)	enikoe.regoes@cern.ch

Proposal 12459 (STScI Edit Number: 4, Created: Monday, August 13, 2012 8:16:25 PM EST) - Overview

<i>Name</i>	<i>Institution</i>	<i>E-Mail</i>
Dr. Adam Riess (CoI)	The Johns Hopkins University	ariess@pha.jhu.edu
Dr. Piero Rosati (CoI) (ESA Member)	European Southern Observatory - Germany	prosati@eso.org
Dr. Stella Seitz (CoI) (ESA Member)	Universitats-Sternwarte Munchen	stella@usm.uni-muenchen.de
Dr. Keiichi Umetsu (CoI)	Academia Sinica, Institute of Astronomy and Astrophysics	keiichi@asiaa.sinica.edu.tw
Dr. Arjen van der Wel (CoI) (ESA Member)	Max-Planck-Institut fur Astronomie, Heidelberg	vdwel@mpia.de
Dr. Wei Zheng (CoI)	The Johns Hopkins University	zheng@pha.jhu.edu
Mr. Adi Zitrin (CoI) (ESA Member)	Universitat Heidelberg	adizitrin@gmail.com
Dr. Steven A. Rodney (CoI) (Contact)	The Johns Hopkins University	rodney@jhu.edu
Ms. Nicole Czakon (CoI)	California Institute of Technology	czakon@gmail.com
Dr. John Moustakas (CoI)	Siena College	jmoustakas@siena.edu

VISITS

<i>Visit</i>	<i>Targets used in Visit</i>	<i>Configurations used in Visit</i>	<i>Orbits Used</i>	<i>Last Orbit Planner Run</i>	<i>OP Current with Visit?</i>
A0	(1) MACS0416-2403 (3) MACS0416-WFC3PAR1	ACS/WFC WFC3/IR WFC3/UVIS	1	13-Aug-2012 21:13:07.0	yes
A1	(1) MACS0416-2403 (3) MACS0416-WFC3PAR1	ACS/WFC WFC3/IR WFC3/UVIS	1	13-Aug-2012 21:13:20.0	yes
A2	(1) MACS0416-2403 (2) MACS0416-ACSPAR1	ACS/WFC WFC3/IR	1	13-Aug-2012 21:13:32.0	yes
A3	(1) MACS0416-2403 (3) MACS0416-WFC3PAR1	ACS/WFC WFC3/IR WFC3/UVIS	1	13-Aug-2012 21:13:42.0	yes
A4	(1) MACS0416-2403 (2) MACS0416-ACSPAR1	ACS/WFC WFC3/IR	1	13-Aug-2012 21:13:52.0	yes
A5	(1) MACS0416-2403 (3) MACS0416-WFC3PAR1	ACS/WFC WFC3/IR WFC3/UVIS	1	13-Aug-2012 21:14:02.0	yes

Proposal 12459 (STScI Edit Number: 4, Created: Monday, August 13, 2012 8:16:25 PM EST) - Overview

<i>Visit</i>	<i>Targets used in Visit</i>	<i>Configurations used in Visit</i>	<i>Orbits Used</i>	<i>Last Orbit Planner Run</i>	<i>OP Current with Visit?</i>
A6	(1) MACS0416-2403 (2) MACS0416-ACSPAR1	ACS/WFC WFC3/UVIS	2	13-Aug-2012 21:14:18.0	yes
A8	(1) MACS0416-2403 (3) MACS0416-WFC3PAR1	ACS/WFC WFC3/IR WFC3/UVIS	1	13-Aug-2012 21:14:30.0	yes
A9	(1) MACS0416-2403 (2) MACS0416-ACSPAR1	ACS/WFC WFC3/IR	1	13-Aug-2012 21:14:40.0	yes
B0	(1) MACS0416-2403 (5) MACS0416-WFC3PAR2	ACS/WFC WFC3/IR WFC3/UVIS	1	13-Aug-2012 21:14:50.0	yes
B1	(1) MACS0416-2403 (4) MACS0416-ACSPAR2	ACS/WFC WFC3/IR	1	13-Aug-2012 21:15:00.0	yes
B2	(1) MACS0416-2403 (5) MACS0416-WFC3PAR2	ACS/WFC WFC3/IR WFC3/UVIS	1	13-Aug-2012 21:15:10.0	yes
B3	(1) MACS0416-2403 (4) MACS0416-ACSPAR2	ACS/WFC WFC3/UVIS	2	13-Aug-2012 21:15:28.0	yes
B5	(1) MACS0416-2403 (5) MACS0416-WFC3PAR2	ACS/WFC WFC3/IR WFC3/UVIS	1	13-Aug-2012 21:15:40.0	yes
B6	(1) MACS0416-2403 (4) MACS0416-ACSPAR2	ACS/WFC WFC3/IR WFC3/UVIS	2	13-Aug-2012 21:15:55.0	yes
B7	(1) MACS0416-2403 (5) MACS0416-WFC3PAR2	ACS/WFC WFC3/IR WFC3/UVIS	1	13-Aug-2012 21:16:06.0	yes
B8	(1) MACS0416-2403 (4) MACS0416-ACSPAR2	ACS/WFC WFC3/IR	1	13-Aug-2012 21:16:16.0	yes

20 Total Orbits Used

ABSTRACT

As the most massive objects in the universe, galaxy clusters represent important signposts in our story of structure evolution, and are the ultimate telescopic lenses, placing gravitationally lensed galaxies from the earliest epochs in comfortable reach for careful study. We take full advantage of the refurbished ACS and WFC3 cameras to deliver deep 14-filter images of 25 carefully chosen clusters. These will enable us to address timely and substantive questions about dark matter, dark energy, and galaxy evolution well beyond $z=7$. These X-ray clusters are chosen to be free of lensing bias and to span a wide range of redshift and mass. By combining strong and weak lensing, we will obtain the definitive mass profile of relaxed clusters to confront the distinctive prediction of the standard Λ CDM model. Detailed maps of internal structure will be enabled by $\sim 1,000$ new multiply-imaged lensed sources to $AB=26$, all with precise ($2\% \times (1+z)$) photometric redshift measurements, thanks to WFC3's UV and IR coverage. A supernovae search in parallel (with low magnification uncertainties) will extend the Hubble diagram of SN1a to $z>1.5$, testing the constancy of dark energy with time and probing progenitor evolution. Our homogeneous panchromatic deep imaging of this cluster sample will constitute a vast legacy archive for studies of the formation and evolution of structure.

OBSERVING DESCRIPTION

There are two special requirements: orientation and cadence. Four epochs must be executed at the same orientation. Each epoch will be between 10 and 14 days, depending on the roll angle availability for the given target. There will be two orientations selected, which will be approximately 20-30 degrees apart.

Proposal 12459 - Visit A0 - Through a Lens, Darkly - New Constraints on the Fundamental Components of the Cosmos

Tue Aug 14 01:16:26 GMT 2012

Visit	Proposal 12459, Visit A0, completed Diagnostic Status: Warning Scientific Instruments: WFC3/IR, WFC3/UVIS, ACS/WFC Special Requirements: SCHED 60%; ORIENT 0D TO 11 D; ORIENT 29D TO 41 D; ORIENT 118D TO 359 D <i>Comments: Visits A0-A2 represent epoch 1 (at orient 1) and should be taken concurrently</i> <i>Orient constraints are to avoid placing a bright star in the parallel fields.</i>									
	(Visit A0) Warning (Orbit Planner): VISIBILITY OVERRUN (Visit A0) Warning (Form): The proposal is part of a large program (100 orbits or more in one cycle) and so should use Schedulability 100.									
Diagnosics										
Fixed Targets	#	Name	Target Coordinates	Targ. Coord. Corrections	Fluxes	Miscellaneous				
	(1)	MACS0416-2403	RA: 04 16 8.3800 (64.0349167d) Dec: -24 04 20.80 (-24.07244d) Equinox: J2000		V=15	Reference Frame: ICRS				
(3)	MACS0416-WFC3PAR1	RA: 04 16 8.3800 (64.0349167d) Dec: -24 04 20.80 (-24.07244d) Equinox: J2000		V=15	Reference Frame: ICRS					
Exposures	#	Label	Target	Config,Mode,Aperture	Spectral Els.	Opt. Params.	Special Reqs.	Groups	Exp. Time/[Actual Dur.]	Orbit
	1	(1) MACS0416-2403	ACS/WFC, ACCUM, WFC-FIX	F625W			POS TARG 0,0; GS ACQ SCENARI O BASE1B3	Prime + Parallel Gro up 1-2 in Visit A0	525 Secs [==>525 Secs]	[1]
	2	(3) MACS0416-WF C3PAR1	WFC3/IR, MULTIACCUM, IR-FIX	F125W	SAMP-SEQ=SPARS 100; NSAMP=8			Prime + Parallel Gro up 1-2 in Visit A0	[==>]	[1]
	3	(1) MACS0416-2403	ACS/WFC, ACCUM, WFC-FIX	F625W			POS TARG 0.0741,0 .1295	Prime + Parallel Gro up 3-4 in Visit A0	507 Secs [==>507.0 Secs]	[1]
	4	(3) MACS0416-WF C3PAR1	WFC3/IR, MULTIACCUM, IR-FIX	F160W	SAMP-SEQ=SPARS 50; NSAMP=13			Prime + Parallel Gro up 3-4 in Visit A0	[==>]	[1]
	5	(1) MACS0416-2403	ACS/WFC, ACCUM, WFC-FIX	F850LP			POS TARG 0.1729,- 0.0848	Prime + Parallel Gro up 5-6 in Visit A0	551 Secs [==>485 Secs]	[1]
	6	(3) MACS0416-WF C3PAR1	WFC3/IR, MULTIACCUM, IR-FIX	F160W	SAMP-SEQ=SPARS 100; NSAMP=7			Prime + Parallel Gro up 5-6 in Visit A0	[==>]	[1]
	7	(1) MACS0416-2403	ACS/WFC, ACCUM, WFC-FIX	F850LP			POS TARG 0.247,0. 2423	Prime + Parallel Gro up 7-8 in Visit A0	564 Secs [==>534 Secs]	[1]
8	(3) MACS0416-WF C3PAR1	WFC3/UVIS, ACCUM, UVIS-FIX	F350LP	CR-SPLIT=NO			Prime + Parallel Gro up 7-8 in Visit A0	400 Secs [==>628 Secs]	[1]	

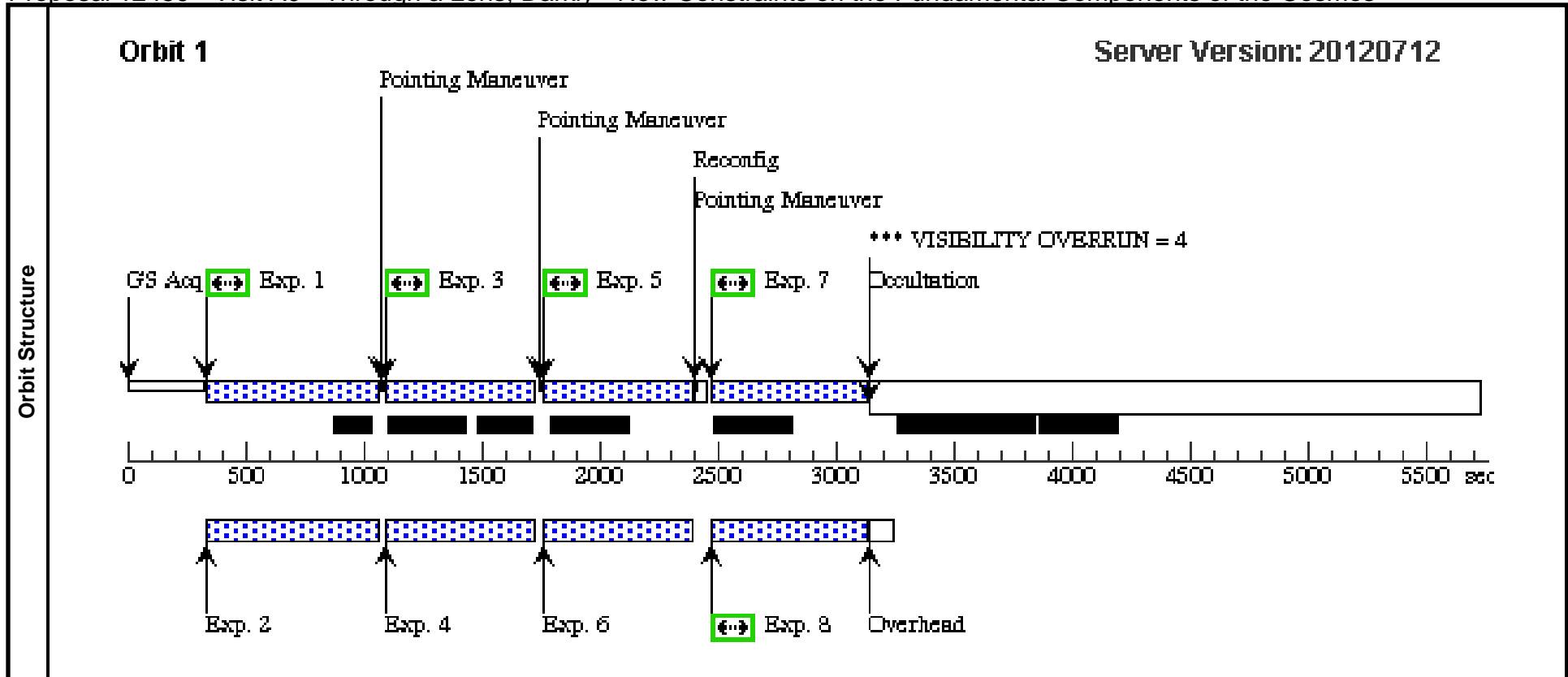

Proposal 12459 - Visit A1 - Through a Lens, Darkly - New Constraints on the Fundamental Components of the Cosmos

Tue Aug 14 01:16:28 GMT 2012

Visit	Proposal 12459, Visit A1, completed Diagnostic Status: Warning Scientific Instruments: WFC3/IR, WFC3/UVIS, ACS/WFC Special Requirements: SCHED 60%; SAME ORIENT AS A0; SEQ A0,A1 WITHIN 1.2 Orbits <i>Comments: Visits A0-A2 represent epoch 1 (at orient 1) and should be taken concurrently</i>									
	Diagnostics	(Visit A1) Warning (Form): The proposal is part of a large program (100 orbits or more in one cycle) and so should use Schedulability 100. (Visit A1) Warning (Orbit Planner): VISIBILITY OVERRUN								
Fixed Targets		#	Name	Target Coordinates	Targ. Coord. Corrections	Fluxes	Miscellaneous			
		(1)	MACS0416-2403	RA: 04 16 8.3800 (64.0349167d) Dec: -24 04 20.80 (-24.07244d) Equinox: J2000		V=15	Reference Frame: ICRS			
	(3)	MACS0416-WFC3PAR1	RA: 04 16 8.3800 (64.0349167d) Dec: -24 04 20.80 (-24.07244d) Equinox: J2000		V=15	Reference Frame: ICRS				
Exposures	#	Label	Target	Config,Mode,Aperture	Spectral Els.	Opt. Params.	Special Reqs.	Groups	Exp. Time/[Actual Dur.]	Orbit
	1		(1) MACS0416-2403	ACS/WFC, ACCUM, WFC-FIX	F475W		POS TARG 0,0; GS ACQ SCENARI O BASE1B3	Prime + Parallel Gro up 1-2 in Visit A1	525 Secs [==>525 Secs]	[1]
	2		(3) MACS0416-WF C3PAR1	WFC3/IR, MULTIACCUM, IR-FIX	F125W	SAMP-SEQ=SPARS 100; NSAMP=8		Prime + Parallel Gro up 1-2 in Visit A1	[==>]	[1]
	3		(1) MACS0416-2403	ACS/WFC, ACCUM, WFC-FIX	F475W		POS TARG 0.0741,0 .1295	Prime + Parallel Gro up 3-4 in Visit A1	507 Secs [==>507.0 Secs]	[1]
	4		(3) MACS0416-WF C3PAR1	WFC3/IR, MULTIACCUM, IR-FIX	F160W	SAMP-SEQ=SPARS 50; NSAMP=13		Prime + Parallel Gro up 3-4 in Visit A1	[==>]	[1]
	5		(1) MACS0416-2403	ACS/WFC, ACCUM, WFC-FIX	F775W		POS TARG 0.1729,- 0.0848	Prime + Parallel Gro up 5-6 in Visit A1	551 Secs [==>481 Secs]	[1]
	6		(3) MACS0416-WF C3PAR1	WFC3/IR, MULTIACCUM, IR-FIX	F160W	SAMP-SEQ=SPARS 100; NSAMP=7		Prime + Parallel Gro up 5-6 in Visit A1	[==>]	[1]
	7		(1) MACS0416-2403	ACS/WFC, ACCUM, WFC-FIX	F775W		POS TARG 0.247,0. 2423	Prime + Parallel Gro up 7-8 in Visit A1	564 Secs [==>534 Secs]	[1]
	8		(3) MACS0416-WF C3PAR1	WFC3/UVIS, ACCUM, UVIS-FIX	F350LP	CR-SPLIT=NO		Prime + Parallel Gro up 7-8 in Visit A1	400 Secs [==>628 Secs]	[1]

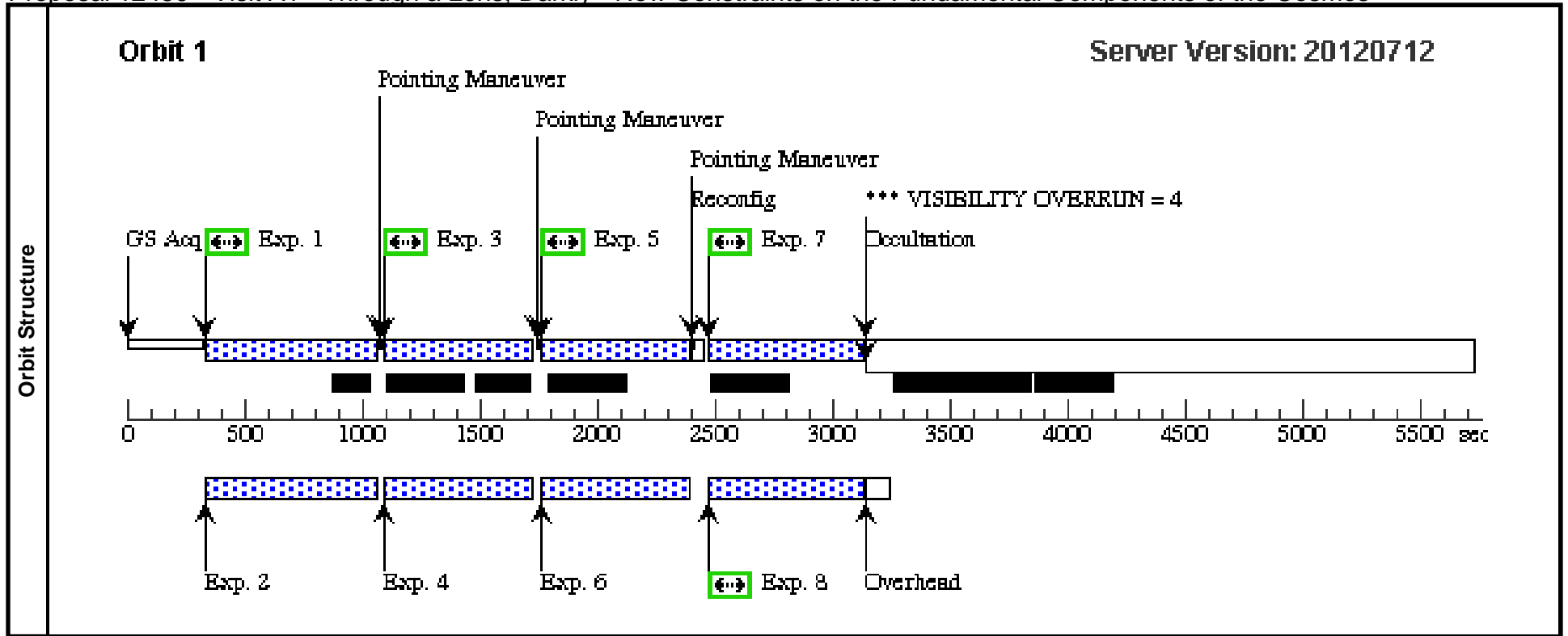

Proposal 12459 - Visit A2 - Through a Lens, Darkly - New Constraints on the Fundamental Components of the Cosmos

Tue Aug 14 01:16:29 GMT 2012

Visit	Proposal 12459, Visit A2, completed Diagnostic Status: Warning Scientific Instruments: WFC3/IR, ACS/WFC Special Requirements: SCHED 60%; SAME ORIENT AS A0; SEQ A1,A2 WITHIN 1.2 Orbits <i>Comments: Visits A0-A2 represent epoch 1 (at orient 1) and should be taken concurrently</i>									
	Diagnostics	(Visit A2) Warning (Orbit Planner): VISIBILITY OVERRUN (Visit A2) Warning (Form): The proposal is part of a large program (100 orbits or more in one cycle) and so should use Schedulability 100.								
Fixed Targets		#	Name	Target Coordinates	Targ. Coord. Corrections	Fluxes	Miscellaneous			
	(1)	MACS0416-2403	RA: 04 16 8.3800 (64.0349167d) Dec: -24 04 20.80 (-24.07244d) Equinox: J2000		V=15	Reference Frame: ICRS				
(2)	MACS0416-ACSPAR1	RA: 04 16 8.3800 (64.0349167d) Dec: -24 04 20.80 (-24.07244d) Equinox: J2000		V=15	Reference Frame: ICRS					
Exposures	#	Label	Target	Config,Mode,Aperture	Spectral Els.	Opt. Params.	Special Reqs.	Groups	Exp. Time/[Actual Dur.]	Orbit
	1		(1) MACS0416-2403	WFC3/IR, MULTIACCUM, IR-FIX	F110W	SAMP-SEQ=SPARS 100; NSAMP=6	POS TARG 0,0; GS ACQ SCENARI O BASE1B3	Prime + Parallel Gro up 1-2 in Visit A2	[==>]	[1]
	2		(2) MACS0416-ACS PAR1	ACS/WFC, ACCUM, WFC-FIX	F850LP			Prime + Parallel Gro up 1-2 in Visit A2	525 Secs [==>325.0 Secs]	[1]
	3		(1) MACS0416-2403	WFC3/IR, MULTIACCUM, IR-FIX	F110W	SAMP-SEQ=SPARS 100; NSAMP=6	POS TARG 0.20325, -0.18165	Prime + Parallel Gro up 3-4 in Visit A2	[==>]	[1]
	4		(2) MACS0416-ACS PAR1	ACS/WFC, ACCUM, WFC-FIX	F850LP			Prime + Parallel Gro up 3-4 in Visit A2	607 Secs [==>407 Secs]	[1]
	5		(1) MACS0416-2403	WFC3/IR, MULTIACCUM, IR-FIX	F110W	SAMP-SEQ=SPARS 100; NSAMP=6	POS TARG 0.47425, 0.6055	Prime + Parallel Gro up 5-6 in Visit A2	[==>]	[1]
	6		(2) MACS0416-ACS PAR1	ACS/WFC, ACCUM, WFC-FIX	F850LP			Prime + Parallel Gro up 5-6 in Visit A2	582 Secs [==>407 Secs]	[1]
	7		(1) MACS0416-2403	WFC3/IR, MULTIACCUM, IR-FIX	F160W	SAMP-SEQ=SPARS 100; NSAMP=6	POS TARG -0.271,0 .42385	Prime + Parallel Gro up 7-8 in Visit A2	[==>]	[1]
	8		(2) MACS0416-ACS PAR1	ACS/WFC, ACCUM, WFC-FIX	F850LP			Prime + Parallel Gro up 7-8 in Visit A2	587 Secs [==>407.0 Secs]	[1]
	9		(1) MACS0416-2403	WFC3/IR, MULTIACCUM, IR-FIX	F160W	SAMP-SEQ=SPARS 100; NSAMP=6	POS TARG 0.47425, 0.6055	Prime + Parallel Gro up 9-10 in Visit A2	[==>]	[1]
10		(2) MACS0416-ACS PAR1	ACS/WFC, ACCUM, WFC-FIX	F775W			Prime + Parallel Gro up 9-10 in Visit A2	587 Secs [==>389 Secs]	[1]	

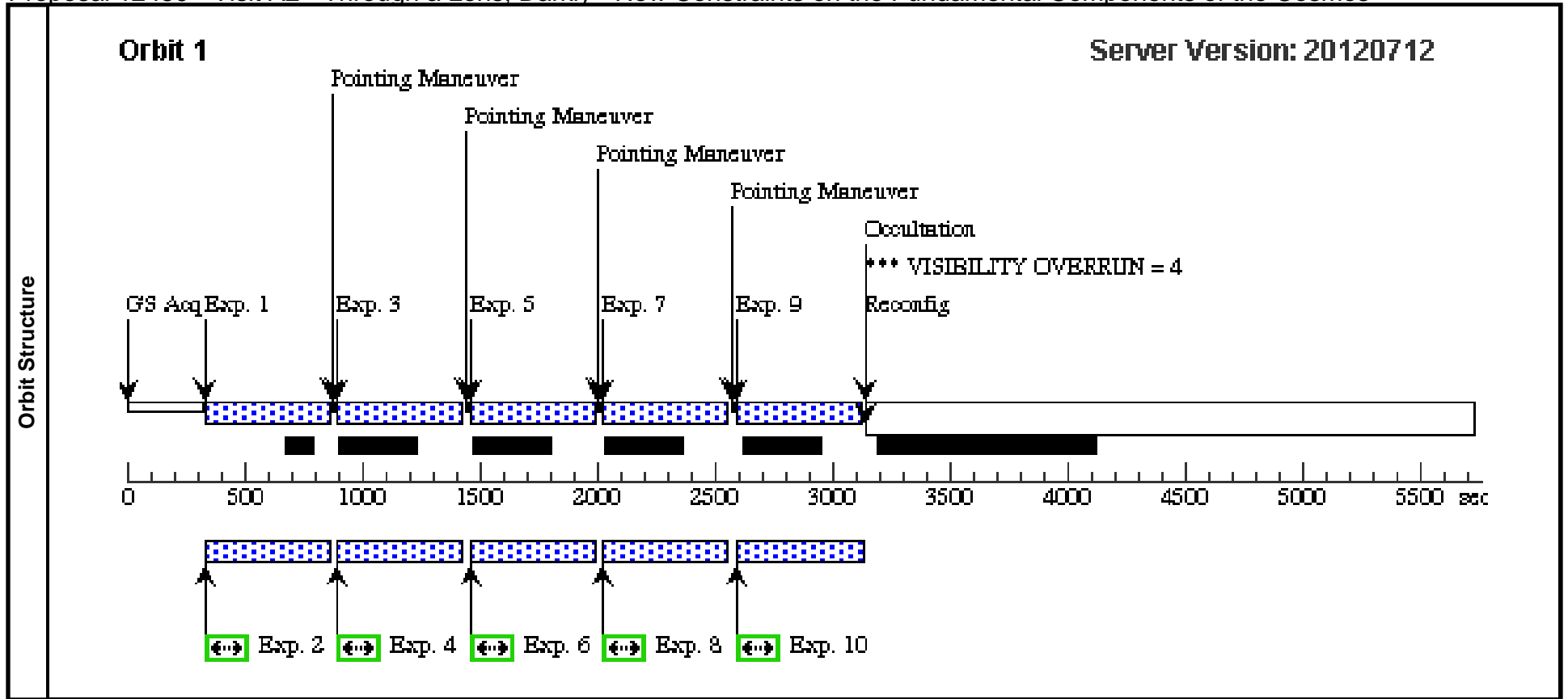

Proposal 12459 - Visit A3 - Through a Lens, Darkly - New Constraints on the Fundamental Components of the Cosmos

Tue Aug 14 01:16:30 GMT 2012

Visit	Proposal 12459, Visit A3, completed Diagnostic Status: Warning Scientific Instruments: WFC3/IR, WFC3/UVIS, ACS/WFC Special Requirements: SCHED 60%; SAME ORIENT AS A0; AFTER A0 BY 12 D TO 14 D <i>Comments: Visits A3-A4 represent epoch 2 (at orient 1) and should be taken concurrently</i>									
	Diagnostics	(Visit A3) Warning (Form): The proposal is part of a large program (100 orbits or more in one cycle) and so should use Schedulability 100. (Visit A3) Warning (Orbit Planner): VISIBILITY OVERRUN								
Fixed Targets		#	Name	Target Coordinates	Targ. Coord. Corrections	Fluxes	Miscellaneous			
	(1)	MACS0416-2403	RA: 04 16 8.3800 (64.0349167d) Dec: -24 04 20.80 (-24.07244d) Equinox: J2000		V=15	Reference Frame: ICRS				
(3)	MACS0416-WFC3PAR1	RA: 04 16 8.3800 (64.0349167d) Dec: -24 04 20.80 (-24.07244d) Equinox: J2000		V=15	Reference Frame: ICRS					
Exposures	#	Label	Target	Config,Mode,Aperture	Spectral Els.	Opt. Params.	Special Reqs.	Groups	Exp. Time/[Actual Dur.]	Orbit
	1		(1) MACS0416-2403	ACS/WFC, ACCUM, WFC-FIX	F606W		POS TARG 0,0; GS ACQ SCENARI O BASE1B3	Prime + Parallel Group 1-2 in Visit A3	525 Secs [==>525 Secs]	[1]
	2		(3) MACS0416-WF C3PAR1	WFC3/IR, MULTIACCUM, IR-FIX	F125W	SAMP-SEQ=SPARS 100; NSAMP=8		Prime + Parallel Group 1-2 in Visit A3	[==>]	[1]
	3		(1) MACS0416-2403	ACS/WFC, ACCUM, WFC-FIX	F606W		POS TARG 0.3211,0 .7917	Prime + Parallel Group 3-4 in Visit A3	507 Secs [==>507.0 Secs]	[1]
	4		(3) MACS0416-WF C3PAR1	WFC3/IR, MULTIACCUM, IR-FIX	F160W	SAMP-SEQ=SPARS 50; NSAMP=13		Prime + Parallel Group 3-4 in Visit A3	[==>]	[1]
	5		(1) MACS0416-2403	ACS/WFC, ACCUM, WFC-FIX	F814W		POS TARG 1.0868,0 .5573	Prime + Parallel Group 5-6 in Visit A3	551 Secs [==>452.0 Secs]	[1]
	6		(3) MACS0416-WF C3PAR1	WFC3/IR, MULTIACCUM, IR-FIX	F160W	SAMP-SEQ=SPARS 100; NSAMP=7		Prime + Parallel Group 5-6 in Visit A3	[==>]	[1]
	7		(1) MACS0416-2403	ACS/WFC, ACCUM, WFC-FIX	F814W		POS TARG -0.3211, -0.1742	Prime + Parallel Group 7-8 in Visit A3	564 Secs [==>534 Secs]	[1]
	8		(3) MACS0416-WF C3PAR1	WFC3/UVIS, ACCUM, UVIS-FIX	F350LP	CR-SPLIT=NO		Prime + Parallel Group 7-8 in Visit A3	400 Secs [==>628 Secs]	[1]

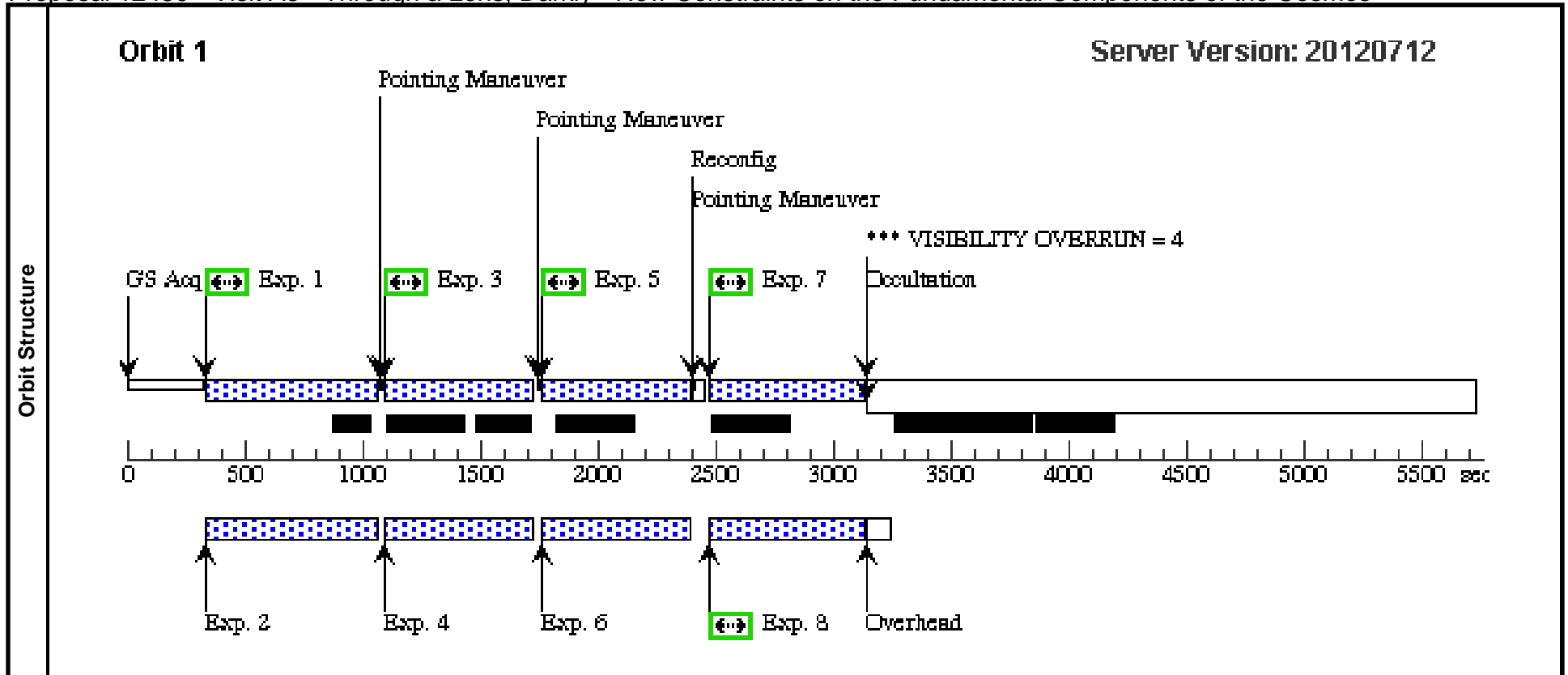

Proposal 12459 - Visit A4 - Through a Lens, Darkly - New Constraints on the Fundamental Components of the Cosmos

Tue Aug 14 01:16:32 GMT 2012

Visit	Proposal 12459, Visit A4, completed Diagnostic Status: Warning Scientific Instruments: WFC3/IR, ACS/WFC Special Requirements: SCHED 60%; SAME ORIENT AS A0; SEQ A3,A4 WITHIN 1.2 Orbits <i>Comments: Visits A3-A4 represent epoch 2 (at orient 1) and should be taken concurrently</i>									
	(Visit A4) Warning (Form): The proposal is part of a large program (100 orbits or more in one cycle) and so should use Schedulability 100. (Visit A4) Warning (Orbit Planner): VISIBILITY OVERRUN									
Fixed Targets	#	Name	Target Coordinates	Targ. Coord. Corrections	Fluxes	Miscellaneous				
	(1)	MACS0416-2403	RA: 04 16 8.3800 (64.0349167d) Dec: -24 04 20.80 (-24.07244d) Equinox: J2000		V=15	Reference Frame: ICRS				
(2)	MACS0416-ACSPAR1	RA: 04 16 8.3800 (64.0349167d) Dec: -24 04 20.80 (-24.07244d) Equinox: J2000		V=15	Reference Frame: ICRS					
Exposures	#	Label	Target	Config,Mode,Aperture	Spectral Els.	Opt. Params.	Special Reqs.	Groups	Exp. Time/[Actual Dur.]	Orbit
	1		(1) MACS0416-2403	WFC3/IR, MULTIACCUM, IR-FIX	F105W	SAMP-SEQ=SPARS 100; NSAMP=6	POS TARG 0,0; GS ACQ SCENARI O BASE1B3	Prime + Parallel Gro up 1-2 in Visit A4	[==>]	[1]
	2		(2) MACS0416-ACS PAR1	ACS/WFC, ACCUM, WFC-FIX	F850LP			Prime + Parallel Gro up 1-2 in Visit A4	525 Secs [==>325.0 Secs]	[1]
	3		(1) MACS0416-2403	WFC3/IR, MULTIACCUM, IR-FIX	F105W	SAMP-SEQ=SPARS 100; NSAMP=6	POS TARG -1.1517 5,0.42385	Prime + Parallel Gro up 3-4 in Visit A4	[==>]	[1]
	4		(2) MACS0416-ACS PAR1	ACS/WFC, ACCUM, WFC-FIX	F850LP			Prime + Parallel Gro up 3-4 in Visit A4	607 Secs [==>407 Secs]	[1]
	5		(1) MACS0416-2403	WFC3/IR, MULTIACCUM, IR-FIX	F105W	SAMP-SEQ=SPARS 100; NSAMP=6	POS TARG -0.813,- 0.30275	Prime + Parallel Gro up 5-6 in Visit A4	[==>]	[1]
	6		(2) MACS0416-ACS PAR1	ACS/WFC, ACCUM, WFC-FIX	F850LP			Prime + Parallel Gro up 5-6 in Visit A4	582 Secs [==>407 Secs]	[1]
	7		(1) MACS0416-2403	WFC3/IR, MULTIACCUM, IR-FIX	F160W	SAMP-SEQ=SPARS 100; NSAMP=6	POS TARG 0.33875, -0.1211	Prime + Parallel Gro up 7-8 in Visit A4	[==>]	[1]
	8		(2) MACS0416-ACS PAR1	ACS/WFC, ACCUM, WFC-FIX	F850LP			Prime + Parallel Gro up 7-8 in Visit A4	587 Secs [==>407.0 Secs]	[1]
	9		(1) MACS0416-2403	WFC3/IR, MULTIACCUM, IR-FIX	F160W	SAMP-SEQ=SPARS 100; NSAMP=6	POS TARG -0.813,- 0.30275	Prime + Parallel Gro up 9-10 in Visit A4	[==>]	[1]
10		(2) MACS0416-ACS PAR1	ACS/WFC, ACCUM, WFC-FIX	F775W			Prime + Parallel Gro up 9-10 in Visit A4	587 Secs [==>389 Secs]	[1]	

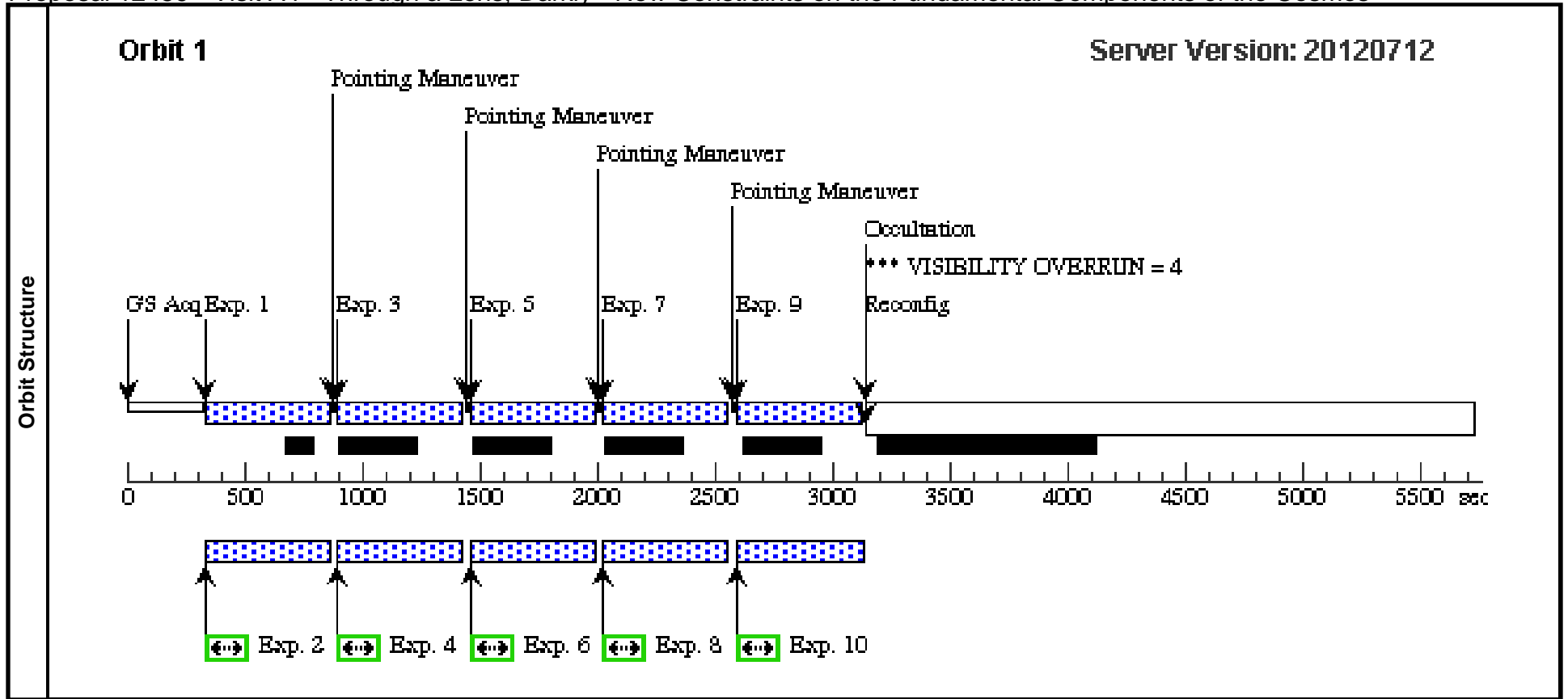

Proposal 12459 - Visit A5 - Through a Lens, Darkly - New Constraints on the Fundamental Components of the Cosmos

Tue Aug 14 01:16:33 GMT 2012

Visit	Proposal 12459, Visit A5, scheduled Diagnostic Status: Warning Scientific Instruments: WFC3/IR, WFC3/UVIS, ACS/WFC Special Requirements: SCHED 60%; SAME ORIENT AS A0; AFTER A0 BY 25 D TO 27 D <i>Comments: Visits A5-A6 represent epoch 3 (at orient 1) and should be taken concurrently</i>									
	Diagnostics	(Visit A5) Warning (Form): The proposal is part of a large program (100 orbits or more in one cycle) and so should use Schedulability 100. (Visit A5) Warning (Orbit Planner): VISIBILITY OVERRUN								
Fixed Targets		#	Name	Target Coordinates	Targ. Coord. Corrections	Fluxes	Miscellaneous			
	(1)	MACS0416-2403	RA: 04 16 8.3800 (64.0349167d) Dec: -24 04 20.80 (-24.07244d) Equinox: J2000		V=15	Reference Frame: ICRS				
(3)	MACS0416-WFC3PAR1	RA: 04 16 8.3800 (64.0349167d) Dec: -24 04 20.80 (-24.07244d) Equinox: J2000		V=15	Reference Frame: ICRS					
Exposures	#	Label	Target	Config,Mode,Aperture	Spectral Els.	Opt. Params.	Special Reqs.	Groups	Exp. Time/[Actual Dur.]	Orbit
	1		(1) MACS0416-2403	ACS/WFC, ACCUM, WFC-FIX	F850LP		POS TARG 0,0; GS ACQ SCENARI O BASE1B3	Prime + Parallel Group 1-2 in Visit A5	525 Secs [==>525 Secs]	[1]
	2		(3) MACS0416-WF C3PAR1	WFC3/IR, MULTIACCUM, IR-FIX	F125W	SAMP-SEQ=SPARS 100; NSAMP=8		Prime + Parallel Group 1-2 in Visit A5	[==>]	[1]
	3		(1) MACS0416-2403	ACS/WFC, ACCUM, WFC-FIX	F850LP		POS TARG 0.3211,0 .7917	Prime + Parallel Group 3-4 in Visit A5	507 Secs [==>507.0 Secs]	[1]
	4		(3) MACS0416-WF C3PAR1	WFC3/IR, MULTIACCUM, IR-FIX	F160W	SAMP-SEQ=SPARS 50; NSAMP=13		Prime + Parallel Group 3-4 in Visit A5	[==>]	[1]
	5		(1) MACS0416-2403	ACS/WFC, ACCUM, WFC-FIX	F814W		POS TARG 1.0868,0 .5573	Prime + Parallel Group 5-6 in Visit A5	551 Secs [==>453 Secs]	[1]
	6		(3) MACS0416-WF C3PAR1	WFC3/IR, MULTIACCUM, IR-FIX	F160W	SAMP-SEQ=SPARS 100; NSAMP=7		Prime + Parallel Group 5-6 in Visit A5	[==>]	[1]
	7		(1) MACS0416-2403	ACS/WFC, ACCUM, WFC-FIX	F814W		POS TARG -0.3211, -0.1742	Prime + Parallel Group 7-8 in Visit A5	564 Secs [==>534 Secs]	[1]
	8		(3) MACS0416-WF C3PAR1	WFC3/UVIS, ACCUM, UVIS-FIX	F350LP	CR-SPLIT=NO		Prime + Parallel Group 7-8 in Visit A5	400 Secs [==>628 Secs]	[1]

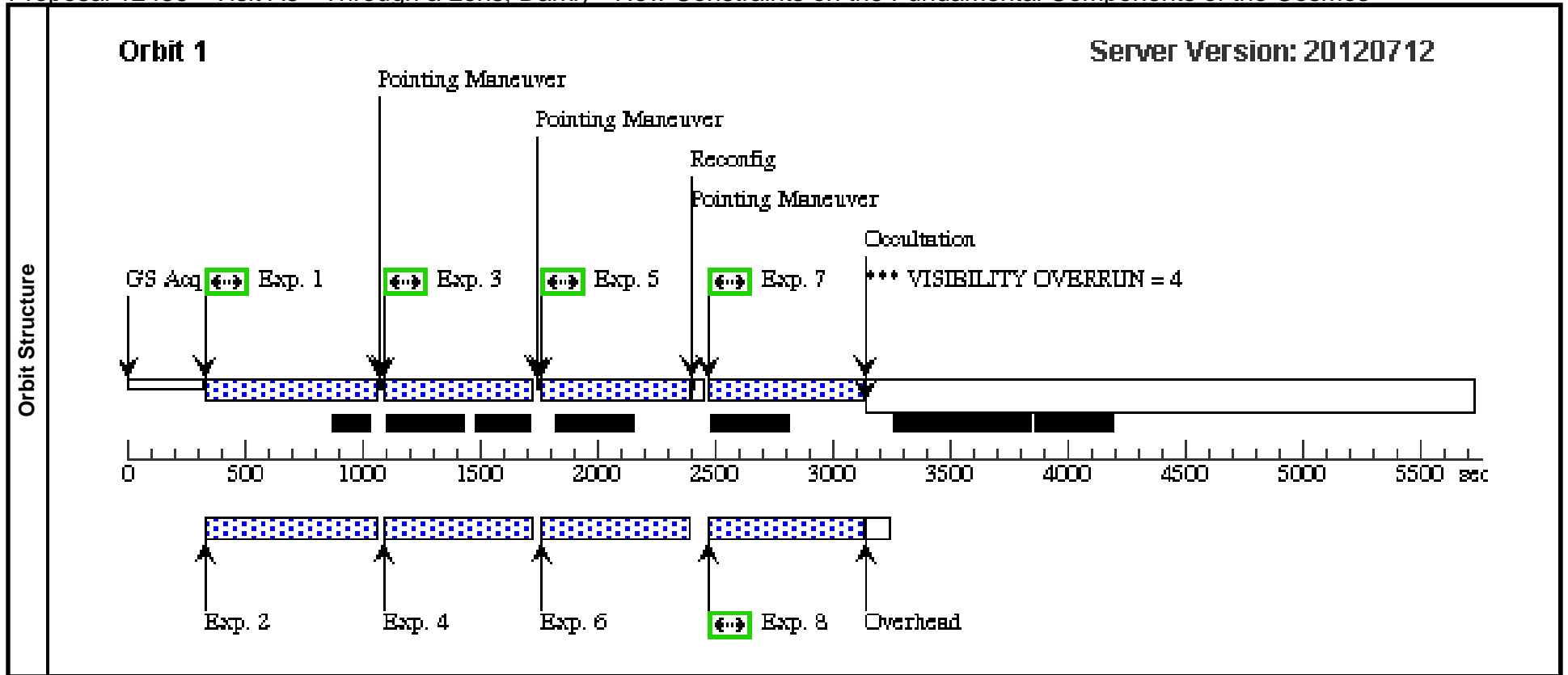

Proposal 12459 - Visit A6 - Through a Lens, Darkly - New Constraints on the Fundamental Components of the Cosmos

Tue Aug 14 01:16:34 GMT 2012

Visit	<p>Proposal 12459, Visit A6, scheduled</p> <p>Diagnostic Status: Warning</p> <p>Scientific Instruments: WFC3/UVIS, ACS/WFC</p> <p>Special Requirements: SCHED 60%; SAME ORIENT AS A0; SEQ A5,A6 WITHIN 1.2 Orbits</p> <p><i>Comments: Visits A5-A6 represent epoch 3 (at orient 1) and should be taken concurrently</i></p>					
	<p>(Visit A6) Warning (Orbit Planner): VISIBILITY OVERRUN</p> <p>(Visit A6) Warning (Form): The proposal is part of a large program (100 orbits or more in one cycle) and so should use Schedulability 100.</p> <p>(Visit A6) Warning (Orbit Planner): VISIBILITY OVERRUN</p>					
Diagnosics						
Fixed Targets	#	Name	Target Coordinates	Targ. Coord. Corrections	Fluxes	Miscellaneous
	(1)	MACS0416-2403	RA: 04 16 8.3800 (64.0349167d) Dec: -24 04 20.80 (-24.07244d) Equinox: J2000		V=15	Reference Frame: ICRS
	(2)	MACS0416-ACSPAR1	RA: 04 16 8.3800 (64.0349167d) Dec: -24 04 20.80 (-24.07244d) Equinox: J2000		V=15	Reference Frame: ICRS

Proposal 12459 - Visit A6 - Through a Lens, Darkly - New Constraints on the Fundamental Components of the Cosmos

Exposures	#	Label	Target	Config,Mode,Aperture	Spectral Els.	Opt. Params.	Special Reqs.	Groups	Exp. Time/[Actual Dur.]	Orbit
	1		(1) MACS0416-2403	WFC3/UVIS, ACCUM, UVIS-FIX	F225W	CR-SPLIT=NO	POS TARG 0,0; GS ACQ SCENARI O.BASE1B3	Prime + Parallel Group 1-2 in Visit A6	600 Secs [==>493 Secs]	[1]
	2		(2) MACS0416-ACS PAR1	ACS/WFC, ACCUM, WFC-FIX	F850LP			Prime + Parallel Group 1-2 in Visit A6	600 Secs [==>413 Secs]	[1]
	3		(1) MACS0416-2403	WFC3/UVIS, ACCUM, UVIS-FIX	F225W	CR-SPLIT=NO	POS TARG 0.0594,- 0.0552	Prime + Parallel Group 3-4 in Visit A6	600 Secs [==>699.0 Secs]	[1]
	4		(2) MACS0416-ACS PAR1	ACS/WFC, ACCUM, WFC-FIX	F850LP			Prime + Parallel Group 3-4 in Visit A6	600 Secs [==>669.0 Secs]	[1]
	5		(1) MACS0416-2403	WFC3/UVIS, ACCUM, UVIS-FIX	F225W	CR-SPLIT=NO	POS TARG 0.1188,0 .06735	Prime + Parallel Group 5-6 in Visit A6	600 Secs [==>699.0 Secs]	[1]
	6		(2) MACS0416-ACS PAR1	ACS/WFC, ACCUM, WFC-FIX	F850LP			Prime + Parallel Group 5-6 in Visit A6	600 Secs [==>669 Secs]	[1]
	7		(1) MACS0416-2403	WFC3/UVIS, ACCUM, UVIS-FIX	F225W	CR-SPLIT=NO	POS TARG -0.0594, 0.15395	Prime + Parallel Group 7-8 in Visit A6	600 Secs [==>493 Secs]	[1]
	8		(2) MACS0416-ACS PAR1	ACS/WFC, ACCUM, WFC-FIX	F775W			Prime + Parallel Group 7-8 in Visit A6	600 Secs [==>342 Secs]	[1]
	9		(1) MACS0416-2403	WFC3/UVIS, ACCUM, UVIS-FIX	F225W	CR-SPLIT=NO	POS TARG 0,0	Prime + Parallel Group 9-10 in Visit A6	600 Secs [==>551 Secs]	[2]
	10		(2) MACS0416-ACS PAR1	ACS/WFC, ACCUM, WFC-FIX	F850LP			Prime + Parallel Group 9-10 in Visit A6	600 Secs [==>495 Secs]	[2]
	11		(1) MACS0416-2403	WFC3/UVIS, ACCUM, UVIS-FIX	F225W	CR-SPLIT=NO	POS TARG 0.0594,- 0.0552	Prime + Parallel Group 11-12 in Visit A6	600 Secs [==>699.0 Secs]	[2]
	12		(2) MACS0416-ACS PAR1	ACS/WFC, ACCUM, WFC-FIX	F850LP			Prime + Parallel Group 11-12 in Visit A6	600 Secs [==>669.0 Secs]	[2]
	13		(1) MACS0416-2403	WFC3/UVIS, ACCUM, UVIS-FIX	F390W	CR-SPLIT=NO	POS TARG 0.1188,0 .06735	Prime + Parallel Group 13-14 in Visit A6	600 Secs [==>699.0 Secs]	[2]
	14		(2) MACS0416-ACS PAR1	ACS/WFC, ACCUM, WFC-FIX	F850LP			Prime + Parallel Group 13-14 in Visit A6	600 Secs [==>695.0 Secs]	[2]
	15		(1) MACS0416-2403	WFC3/UVIS, ACCUM, UVIS-FIX	F390W	CR-SPLIT=NO	POS TARG -0.0594, 0.15395	Prime + Parallel Group 15-16 in Visit A6	600 Secs [==>552 Secs]	[2]
16		(2) MACS0416-ACS PAR1	ACS/WFC, ACCUM, WFC-FIX	F775W			Prime + Parallel Group 15-16 in Visit A6	600 Secs [==>401 Secs]	[2]	

Orbit 1

Server Version: 20120712

Orbit Structure

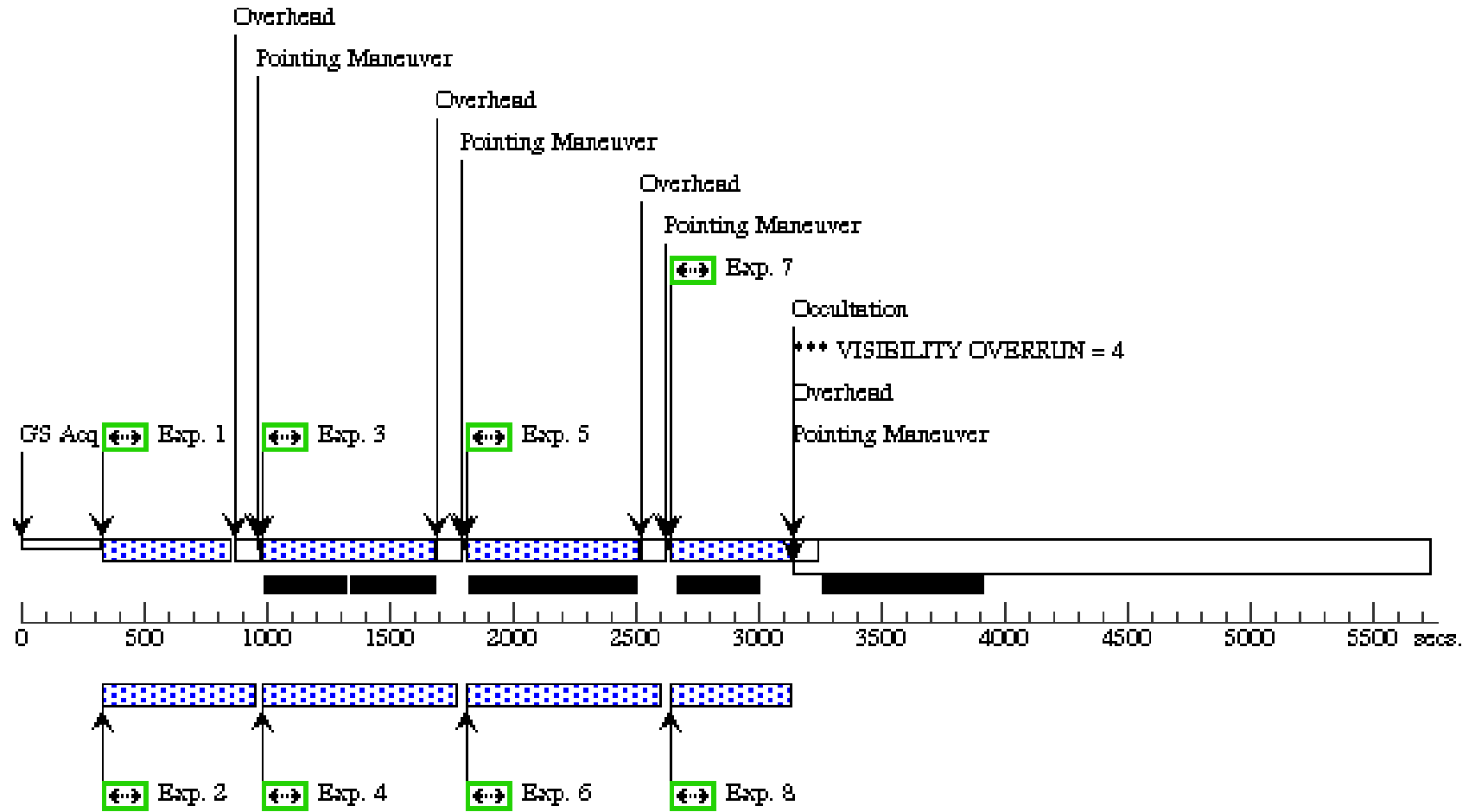

Orbit 2

Server Version: 20120712

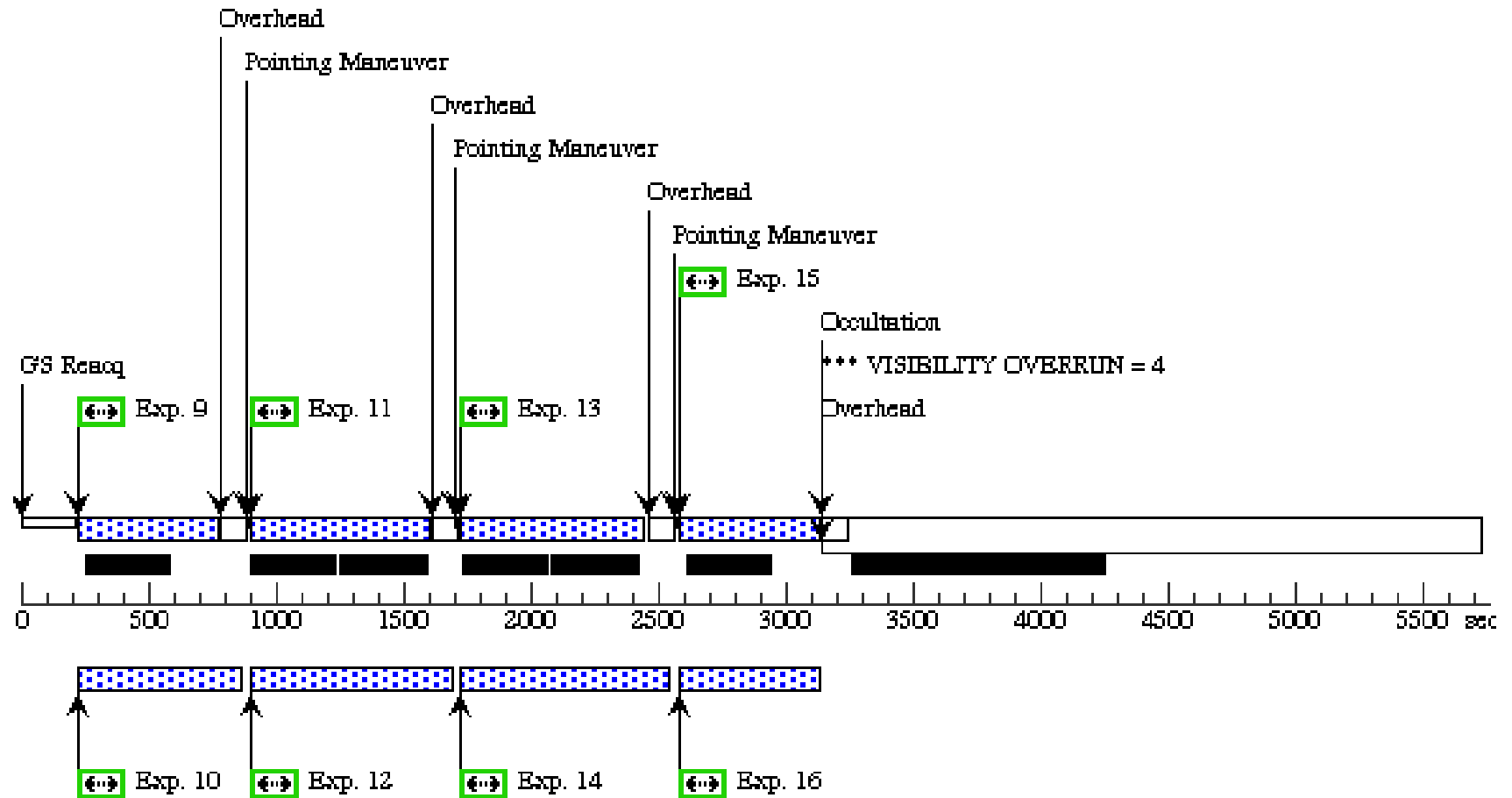

Proposal 12459 - Visit A8 - Through a Lens, Darkly - New Constraints on the Fundamental Components of the Cosmos

Tue Aug 14 01:16:36 GMT 2012

Visit	Proposal 12459, Visit A8, scheduling Diagnostic Status: Warning Scientific Instruments: WFC3/IR, WFC3/UVIS, ACS/WFC Special Requirements: SCHED 60%; SAME ORIENT AS A0; AFTER A0 BY 38 D TO 40 D <i>Comments: Visits A8-A9 represent epoch 4 (at orient 1) and should be taken concurrently</i>									
	Diagnostics	(Visit A8) Warning (Form): The proposal is part of a large program (100 orbits or more in one cycle) and so should use Schedulability 100. (Visit A8) Warning (Orbit Planner): VISIBILITY OVERRUN								
Fixed Targets		#	Name	Target Coordinates	Targ. Coord. Corrections	Fluxes	Miscellaneous			
	(1)	MACS0416-2403	RA: 04 16 8.3800 (64.0349167d) Dec: -24 04 20.80 (-24.07244d) Equinox: J2000		V=15	Reference Frame: ICRS				
(3)	MACS0416-WFC3PAR1	RA: 04 16 8.3800 (64.0349167d) Dec: -24 04 20.80 (-24.07244d) Equinox: J2000		V=15	Reference Frame: ICRS					
Exposures	#	Label	Target	Config,Mode,Aperture	Spectral Els.	Opt. Params.	Special Reqs.	Groups	Exp. Time/[Actual Dur.]	Orbit
	1		(1) MACS0416-2403	ACS/WFC, ACCUM, WFC-FIX	F814W		POS TARG 0,0; GS ACQ SCENARI O BASE1B3	Prime + Parallel Group 1-2 in Visit A8	525 Secs [==>525 Secs]	[1]
	2		(3) MACS0416-WF C3PAR1	WFC3/IR, MULTIACCUM, IR-FIX	F125W	SAMP-SEQ=SPARS 100; NSAMP=8		Prime + Parallel Group 1-2 in Visit A8	[==>]	[1]
	3		(1) MACS0416-2403	ACS/WFC, ACCUM, WFC-FIX	F814W		POS TARG 0.3211,0 .7917	Prime + Parallel Group 3-4 in Visit A8	507 Secs [==>507.0 Secs]	[1]
	4		(3) MACS0416-WF C3PAR1	WFC3/IR, MULTIACCUM, IR-FIX	F160W	SAMP-SEQ=SPARS 50; NSAMP=13		Prime + Parallel Group 3-4 in Visit A8	[==>]	[1]
	5		(1) MACS0416-2403	ACS/WFC, ACCUM, WFC-FIX	F606W		POS TARG 1.0868,0 .5573	Prime + Parallel Group 5-6 in Visit A8	551 Secs [==>452 Secs]	[1]
	6		(3) MACS0416-WF C3PAR1	WFC3/IR, MULTIACCUM, IR-FIX	F160W	SAMP-SEQ=SPARS 100; NSAMP=7		Prime + Parallel Group 5-6 in Visit A8	[==>]	[1]
	7		(1) MACS0416-2403	ACS/WFC, ACCUM, WFC-FIX	F606W		POS TARG -0.3211, -0.1742	Prime + Parallel Group 7-8 in Visit A8	564 Secs [==>534 Secs]	[1]
	8		(3) MACS0416-WF C3PAR1	WFC3/UVIS, ACCUM, UVIS-FIX	F350LP	CR-SPLIT=NO		Prime + Parallel Group 7-8 in Visit A8	400 Secs [==>628 Secs]	[1]

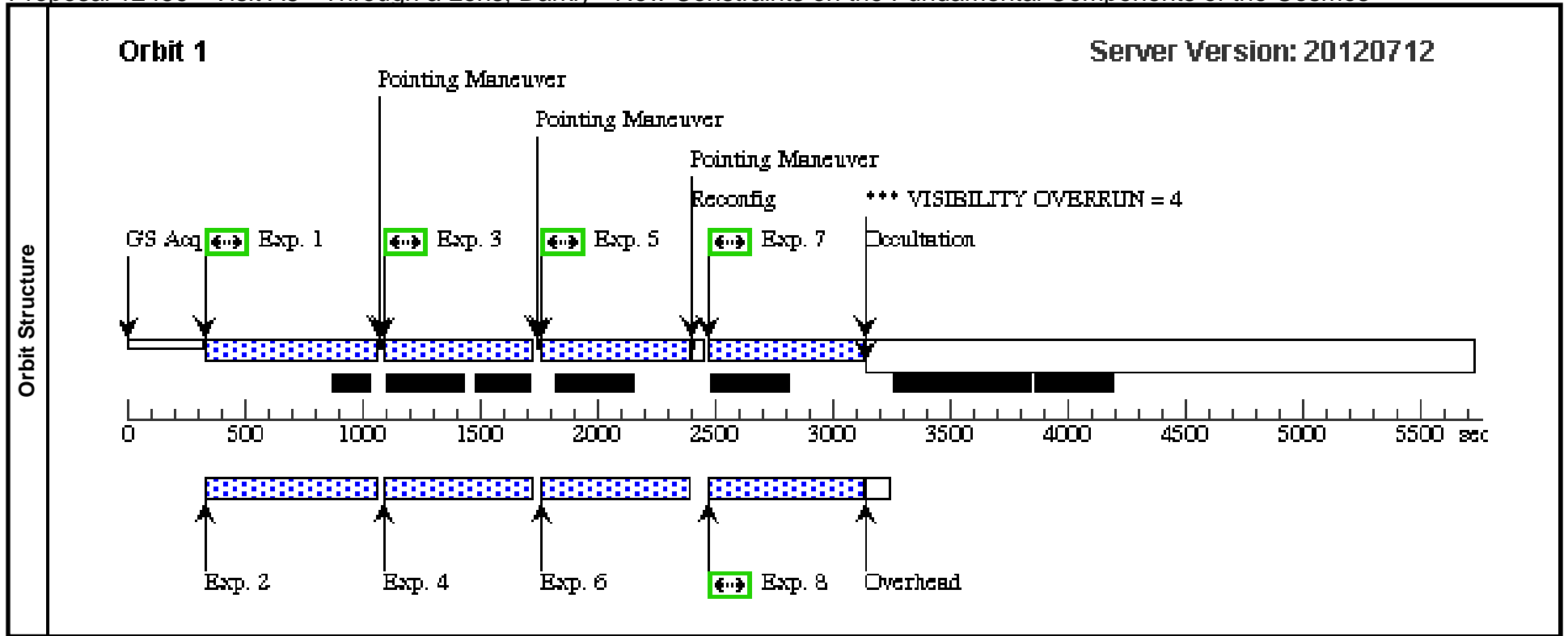

Proposal 12459 - Visit A9 - Through a Lens, Darkly - New Constraints on the Fundamental Components of the Cosmos

Tue Aug 14 01:16:37 GMT 2012

Visit	Proposal 12459, Visit A9, scheduling Diagnostic Status: Warning Scientific Instruments: WFC3/IR, ACS/WFC Special Requirements: SCHED 60%; SAME ORIENT AS A0; SEQ A8,A9 WITHIN 1.2 Orbits <i>Comments: Visits A8-A9 represent epoch 4 (at orient 1) and should be taken concurrently</i>									
	Diagnostics	(Visit A9) Warning (Orbit Planner): VISIBILITY OVERRUN (Visit A9) Warning (Form): The proposal is part of a large program (100 orbits or more in one cycle) and so should use Schedulability 100.								
Fixed Targets		#	Name	Target Coordinates	Targ. Coord. Corrections	Fluxes	Miscellaneous			
	(1)	MACS0416-2403	RA: 04 16 8.3800 (64.0349167d) Dec: -24 04 20.80 (-24.07244d) Equinox: J2000		V=15	Reference Frame: ICRS				
(2)	MACS0416-ACSPAR1	RA: 04 16 8.3800 (64.0349167d) Dec: -24 04 20.80 (-24.07244d) Equinox: J2000		V=15	Reference Frame: ICRS					
Exposures	#	Label	Target	Config,Mode,Aperture	Spectral Els.	Opt. Params.	Special Reqs.	Groups	Exp. Time/[Actual Dur.]	Orbit
	1		(1) MACS0416-2403	WFC3/IR, MULTIACCUM, IR-FIX	F160W	SAMP-SEQ=SPARS 100; NSAMP=6	POS TARG 0,0; GS ACQ SCENARI O BASE1B3	Prime + Parallel Gro up 1-2 in Visit A9	[==>]	[1]
	2		(2) MACS0416-ACS PAR1	ACS/WFC, ACCUM, WFC-FIX	F850LP			Prime + Parallel Gro up 1-2 in Visit A9	525 Secs [==>325.0 Secs]	[1]
	3		(1) MACS0416-2403	WFC3/IR, MULTIACCUM, IR-FIX	F160W	SAMP-SEQ=SPARS 100; NSAMP=6	POS TARG -1.1517 5,0.42385	Prime + Parallel Gro up 3-4 in Visit A9	[==>]	[1]
	4		(2) MACS0416-ACS PAR1	ACS/WFC, ACCUM, WFC-FIX	F850LP			Prime + Parallel Gro up 3-4 in Visit A9	607 Secs [==>407 Secs]	[1]
	5		(1) MACS0416-2403	WFC3/IR, MULTIACCUM, IR-FIX	F160W	SAMP-SEQ=SPARS 100; NSAMP=6	POS TARG -0.813,- 0.30275	Prime + Parallel Gro up 5-6 in Visit A9	[==>]	[1]
	6		(2) MACS0416-ACS PAR1	ACS/WFC, ACCUM, WFC-FIX	F850LP			Prime + Parallel Gro up 5-6 in Visit A9	582 Secs [==>407 Secs]	[1]
	7		(1) MACS0416-2403	WFC3/IR, MULTIACCUM, IR-FIX	F110W	SAMP-SEQ=SPARS 100; NSAMP=6	POS TARG 0.33875, -0.1211	Prime + Parallel Gro up 7-8 in Visit A9	[==>]	[1]
	8		(2) MACS0416-ACS PAR1	ACS/WFC, ACCUM, WFC-FIX	F850LP			Prime + Parallel Gro up 7-8 in Visit A9	587 Secs [==>407.0 Secs]	[1]
	9		(1) MACS0416-2403	WFC3/IR, MULTIACCUM, IR-FIX	F110W	SAMP-SEQ=SPARS 100; NSAMP=6	POS TARG -0.813,- 0.30275	Prime + Parallel Gro up 9-10 in Visit A9	[==>]	[1]
10		(2) MACS0416-ACS PAR1	ACS/WFC, ACCUM, WFC-FIX	F775W			Prime + Parallel Gro up 9-10 in Visit A9	587 Secs [==>389 Secs]	[1]	

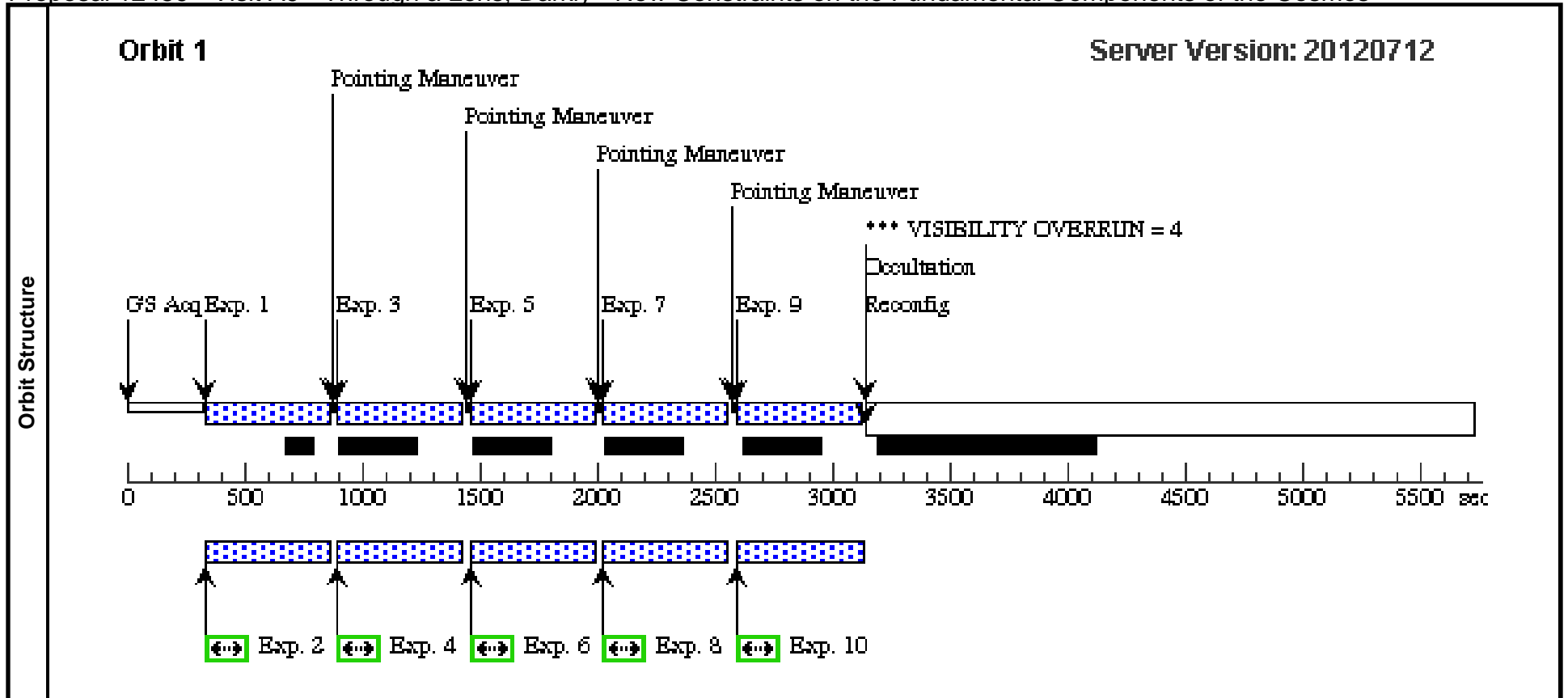

Proposal 12459 - Visit B0 - Through a Lens, Darkly - New Constraints on the Fundamental Components of the Cosmos

Tue Aug 14 01:16:38 GMT 2012

Visit	Proposal 12459, Visit B0, scheduled Diagnostic Status: Warning Scientific Instruments: WFC3/IR, WFC3/UVIS, ACS/WFC Special Requirements: SCHED 60%; ORIENT 29D TO 31D FROM A0 <i>Comments: Visits B0-B1 represent epoch 1 (at orient 2) and should be taken concurrently</i>									
	Diagnostics	(Visit B0) Warning (Orbit Planner): VISIBILITY OVERRUN (Visit B0) Warning (Form): The proposal is part of a large program (100 orbits or more in one cycle) and so should use Schedulability 100.								
Fixed Targets		#	Name	Target Coordinates	Targ. Coord. Corrections	Fluxes	Miscellaneous			
	(1)	MACS0416-2403	RA: 04 16 8.3800 (64.0349167d) Dec: -24 04 20.80 (-24.07244d) Equinox: J2000		V=15	Reference Frame: ICRS				
(5)	MACS0416-WFC3PAR2	RA: 04 16 8.3800 (64.0349167d) Dec: -24 04 20.80 (-24.07244d) Equinox: J2000		V=15	Reference Frame: ICRS					
Exposures	#	Label	Target	Config,Mode,Aperture	Spectral Els.	Opt. Params.	Special Reqs.	Groups	Exp. Time/[Actual Dur.]	Orbit
	1		(1) MACS0416-2403	ACS/WFC, ACCUM, WFC-FIX	F435W		POS TARG 0,0; GS ACQ SCENARI O BASE1B3	Prime + Parallel Gro up 1-2 in Visit B0	525 Secs [==>525 Secs]	[1]
	2		(5) MACS0416-WF C3PAR2	WFC3/IR, MULTIACCUM, IR-FIX	F125W	SAMP-SEQ=SPARS 100; NSAMP=8		Prime + Parallel Gro up 1-2 in Visit B0	[==>]	[1]
	3		(1) MACS0416-2403	ACS/WFC, ACCUM, WFC-FIX	F435W		POS TARG 0.0741,0 .1295	Prime + Parallel Gro up 3-4 in Visit B0	507 Secs [==>507.0 Secs]	[1]
	4		(5) MACS0416-WF C3PAR2	WFC3/IR, MULTIACCUM, IR-FIX	F160W	SAMP-SEQ=SPARS 50; NSAMP=13		Prime + Parallel Gro up 3-4 in Visit B0	[==>]	[1]
	5		(1) MACS0416-2403	ACS/WFC, ACCUM, WFC-FIX	F625W		POS TARG 0.1729,- 0.0848	Prime + Parallel Gro up 5-6 in Visit B0	551 Secs [==>451.0 Secs]	[1]
	6		(5) MACS0416-WF C3PAR2	WFC3/IR, MULTIACCUM, IR-FIX	F160W	SAMP-SEQ=SPARS 100; NSAMP=7		Prime + Parallel Gro up 5-6 in Visit B0	[==>]	[1]
	7		(1) MACS0416-2403	ACS/WFC, ACCUM, WFC-FIX	F625W		POS TARG 0.247,0. 2423	Prime + Parallel Gro up 7-8 in Visit B0	564 Secs [==>534 Secs]	[1]
	8		(5) MACS0416-WF C3PAR2	WFC3/UVIS, ACCUM, UVIS-FIX	F350LP	CR-SPLIT=NO		Prime + Parallel Gro up 7-8 in Visit B0	400 Secs [==>628 Secs]	[1]

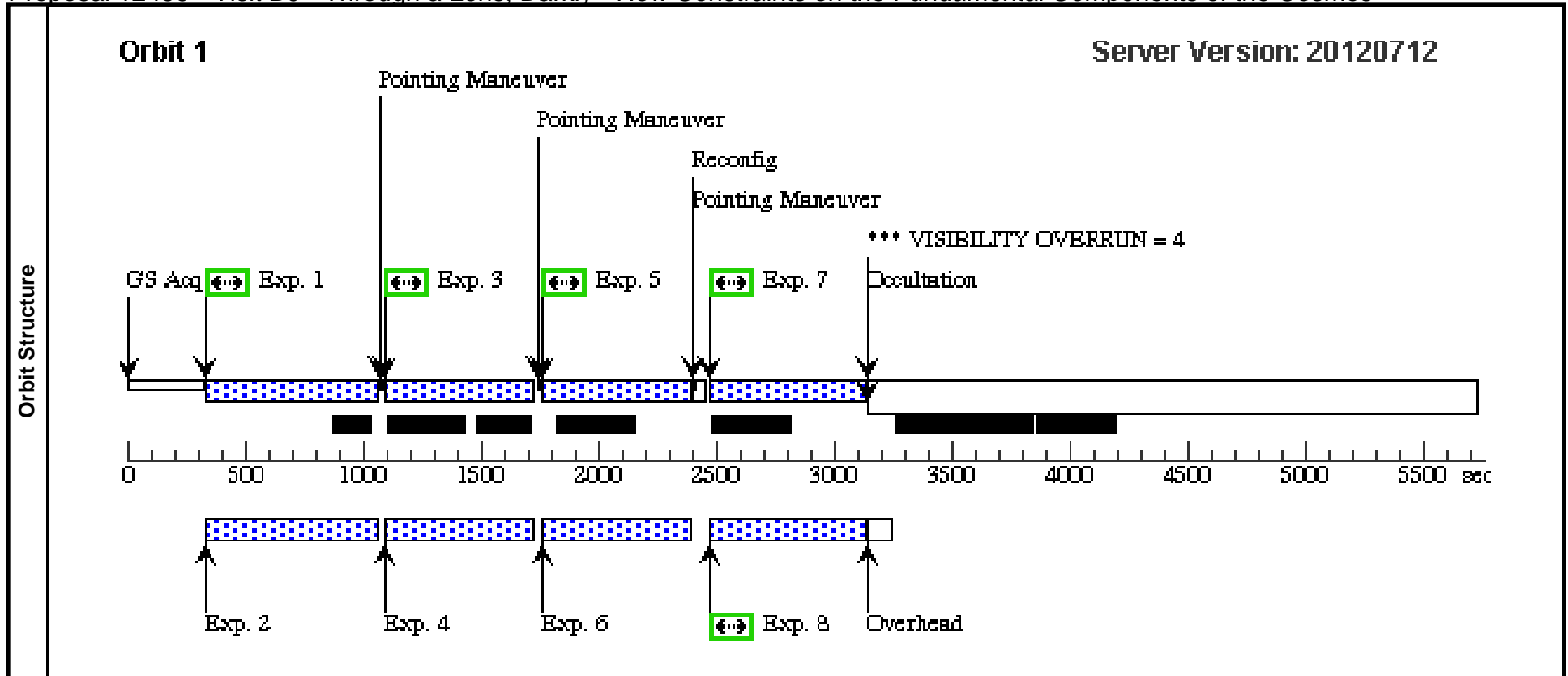

Proposal 12459 - Visit B1 - Through a Lens, Darkly - New Constraints on the Fundamental Components of the Cosmos

Tue Aug 14 01:16:39 GMT 2012

Visit	Proposal 12459, Visit B1, scheduled Diagnostic Status: Warning Scientific Instruments: WFC3/IR, ACS/WFC Special Requirements: SCHED 60%; SAME ORIENT AS B0; SEQ B0,B1 WITHIN 1.2 Orbits <i>Comments: Visits B0-B1 represent epoch 1 (at orient 2) and should be taken concurrently</i>									
	Diagnostics	(Visit B1) Warning (Form): The proposal is part of a large program (100 orbits or more in one cycle) and so should use Schedulability 100. (Visit B1) Warning (Orbit Planner): VISIBILITY OVERRUN								
Fixed Targets		#	Name	Target Coordinates	Targ. Coord. Corrections	Fluxes	Miscellaneous			
	(1)	MACS0416-2403	RA: 04 16 8.3800 (64.0349167d) Dec: -24 04 20.80 (-24.07244d) Equinox: J2000		V=15	Reference Frame: ICRS				
(4)	MACS0416-ACSPAR2	RA: 04 16 8.3800 (64.0349167d) Dec: -24 04 20.80 (-24.07244d) Equinox: J2000		V=15	Reference Frame: ICRS					
Exposures	#	Label	Target	Config,Mode,Aperture	Spectral Els.	Opt. Params.	Special Reqs.	Groups	Exp. Time/[Actual Dur.]	Orbit
	1		(1) MACS0416-2403	WFC3/IR, MULTIACCUM, IR-FIX	F125W	SAMP-SEQ=SPARS 100; NSAMP=6	POS TARG 0,0; GS ACQ SCENARI O BASE1B3	Prime + Parallel Gro up 1-2 in Visit B1	[==>]	[1]
	2		(4) MACS0416-ACS PAR2	ACS/WFC, ACCUM, WFC-FIX	F850LP			Prime + Parallel Gro up 1-2 in Visit B1	525 Secs [==>325.0 Secs]	[1]
	3		(1) MACS0416-2403	WFC3/IR, MULTIACCUM, IR-FIX	F125W	SAMP-SEQ=SPARS 100; NSAMP=6	POS TARG 0.20325, -0.18165	Prime + Parallel Gro up 3-4 in Visit B1	[==>]	[1]
	4		(4) MACS0416-ACS PAR2	ACS/WFC, ACCUM, WFC-FIX	F850LP			Prime + Parallel Gro up 3-4 in Visit B1	607 Secs [==>407 Secs]	[1]
	5		(1) MACS0416-2403	WFC3/IR, MULTIACCUM, IR-FIX	F125W	SAMP-SEQ=SPARS 100; NSAMP=6	POS TARG 0.47425, 0.6055	Prime + Parallel Gro up 5-6 in Visit B1	[==>]	[1]
	6		(4) MACS0416-ACS PAR2	ACS/WFC, ACCUM, WFC-FIX	F850LP			Prime + Parallel Gro up 5-6 in Visit B1	582 Secs [==>407 Secs]	[1]
	7		(1) MACS0416-2403	WFC3/IR, MULTIACCUM, IR-FIX	F140W	SAMP-SEQ=SPARS 100; NSAMP=6	POS TARG -0.271,0 .42385	Prime + Parallel Gro up 7-8 in Visit B1	[==>]	[1]
	8		(4) MACS0416-ACS PAR2	ACS/WFC, ACCUM, WFC-FIX	F850LP			Prime + Parallel Gro up 7-8 in Visit B1	587 Secs [==>407.0 Secs]	[1]
	9		(1) MACS0416-2403	WFC3/IR, MULTIACCUM, IR-FIX	F140W	SAMP-SEQ=SPARS 100; NSAMP=6	POS TARG 0.47425, 0.6055	Prime + Parallel Gro up 9-10 in Visit B1	[==>]	[1]
10		(4) MACS0416-ACS PAR2	ACS/WFC, ACCUM, WFC-FIX	F775W			Prime + Parallel Gro up 9-10 in Visit B1	587 Secs [==>389 Secs]	[1]	

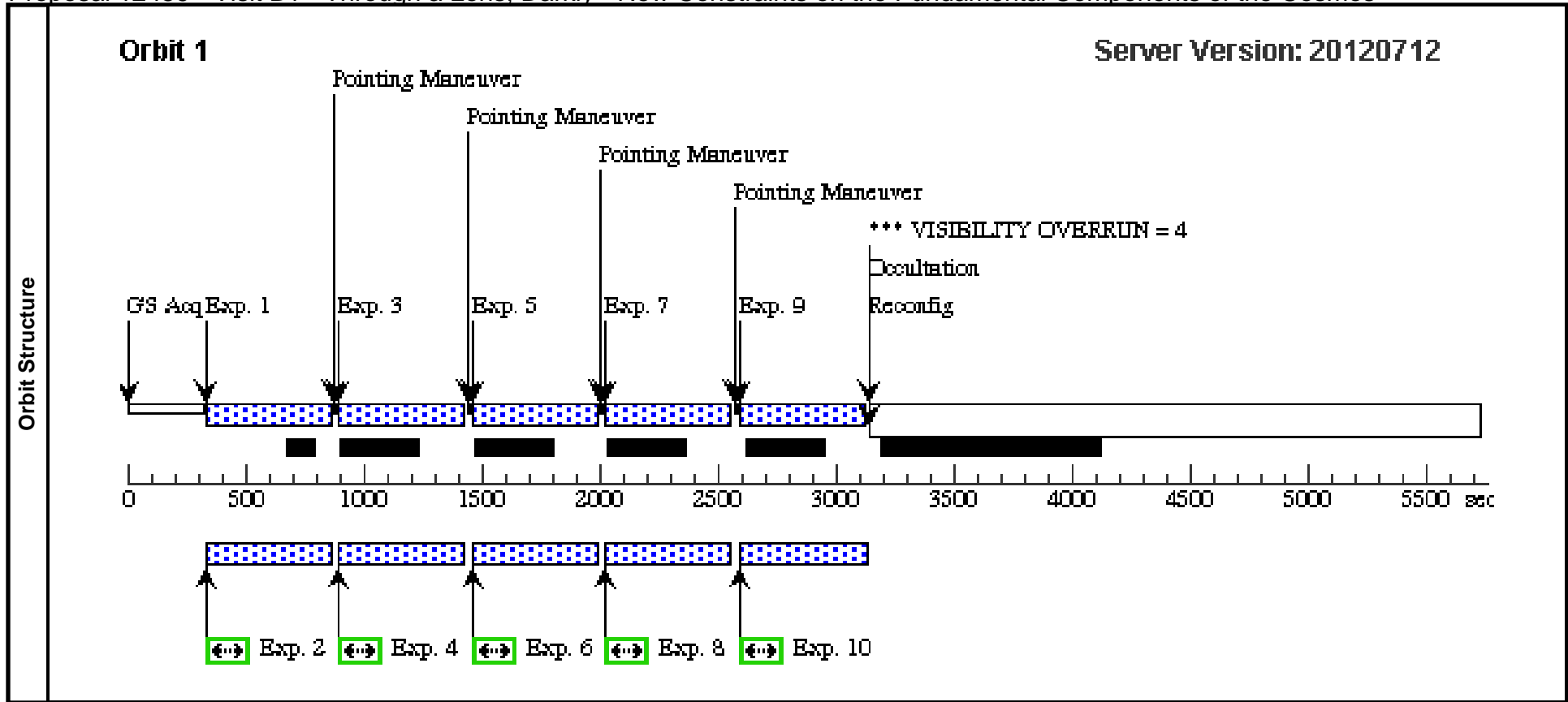

Proposal 12459 - Visit B2 - Through a Lens, Darkly - New Constraints on the Fundamental Components of the Cosmos

Tue Aug 14 01:16:40 GMT 2012

Visit	Proposal 12459, Visit B2, scheduling Diagnostic Status: Warning Scientific Instruments: WFC3/IR, WFC3/UVIS, ACS/WFC Special Requirements: SCHED 60%; SAME ORIENT AS B0; AFTER B0 BY 12 D TO 14 D <i>Comments: Visits B2-B3 represent epoch 2 (at orient 2) and should be taken concurrently</i>									
	Diagnostics	(Visit B2) Warning (Form): The proposal is part of a large program (100 orbits or more in one cycle) and so should use Schedulability 100. (Visit B2) Warning (Orbit Planner): VISIBILITY OVERRUN								
Fixed Targets		#	Name	Target Coordinates	Targ. Coord. Corrections	Fluxes	Miscellaneous			
	(1)	MACS0416-2403	RA: 04 16 8.3800 (64.0349167d) Dec: -24 04 20.80 (-24.07244d) Equinox: J2000		V=15	Reference Frame: ICRS				
(5)	MACS0416-WFC3PAR2	RA: 04 16 8.3800 (64.0349167d) Dec: -24 04 20.80 (-24.07244d) Equinox: J2000		V=15	Reference Frame: ICRS					
Exposures	#	Label	Target	Config,Mode,Aperture	Spectral Els.	Opt. Params.	Special Reqs.	Groups	Exp. Time/[Actual Dur.]	Orbit
	1		(1) MACS0416-2403	ACS/WFC, ACCUM, WFC-FIX	F850LP		POS TARG 0,0; GS ACQ SCENARI O BASE1B3	Prime + Parallel Group 1-2 in Visit B2	525 Secs [==>525 Secs]	[1]
	2		(5) MACS0416-WF C3PAR2	WFC3/IR, MULTIACCUM, IR-FIX	F125W	SAMP-SEQ=SPARS 100; NSAMP=8		Prime + Parallel Group 1-2 in Visit B2	[==>]	[1]
	3		(1) MACS0416-2403	ACS/WFC, ACCUM, WFC-FIX	F850LP		POS TARG 0.3211,0 .7917	Prime + Parallel Group 3-4 in Visit B2	507 Secs [==>507.0 Secs]	[1]
	4		(5) MACS0416-WF C3PAR2	WFC3/IR, MULTIACCUM, IR-FIX	F160W	SAMP-SEQ=SPARS 50; NSAMP=13		Prime + Parallel Group 3-4 in Visit B2	[==>]	[1]
	5		(1) MACS0416-2403	ACS/WFC, ACCUM, WFC-FIX	F775W		POS TARG 1.0868,0 .5573	Prime + Parallel Group 5-6 in Visit B2	551 Secs [==>482 Secs]	[1]
	6		(5) MACS0416-WF C3PAR2	WFC3/IR, MULTIACCUM, IR-FIX	F160W	SAMP-SEQ=SPARS 100; NSAMP=7		Prime + Parallel Group 5-6 in Visit B2	[==>]	[1]
	7		(1) MACS0416-2403	ACS/WFC, ACCUM, WFC-FIX	F775W		POS TARG -0.3211, -0.1742	Prime + Parallel Group 7-8 in Visit B2	564 Secs [==>534 Secs]	[1]
	8		(5) MACS0416-WF C3PAR2	WFC3/UVIS, ACCUM, UVIS-FIX	F350LP	CR-SPLIT=NO		Prime + Parallel Group 7-8 in Visit B2	400 Secs [==>628 Secs]	[1]

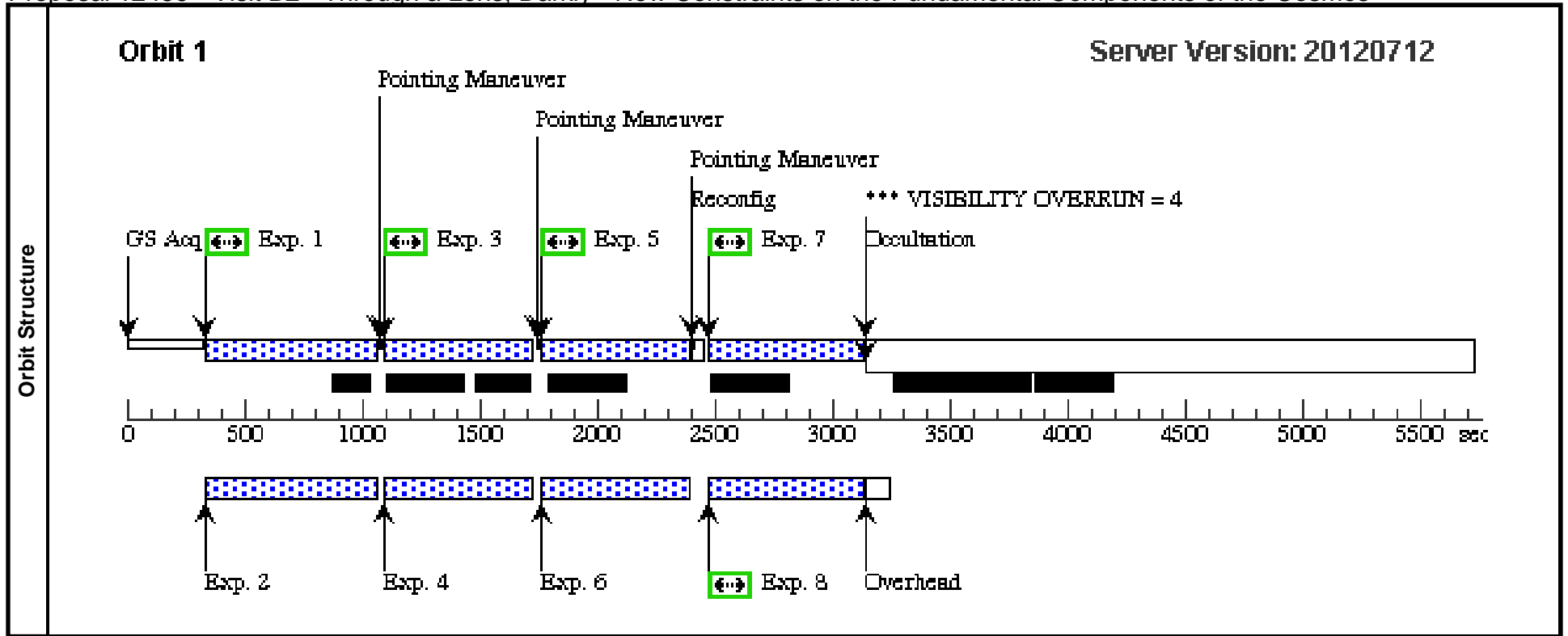

Proposal 12459 - Visit B3 - Through a Lens, Darkly - New Constraints on the Fundamental Components of the Cosmos

Tue Aug 14 01:16:41 GMT 2012

Visit	<p>Proposal 12459, Visit B3, scheduling</p> <p>Diagnostic Status: Warning</p> <p>Scientific Instruments: WFC3/UVIS, ACS/WFC</p> <p>Special Requirements: SCHED 60%; SAME ORIENT AS B0; SEQ B2,B3 WITHIN 1.2 Orbits</p> <p><i>Comments: Visits B2-B3 represent epoch 2 (at orient 2) and should be taken concurrently</i></p>						
	Diagnostics	<p>(Visit B3) Warning (Orbit Planner): VISIBILITY OVERRUN</p> <p>(Visit B3) Warning (Form): The proposal is part of a large program (100 orbits or more in one cycle) and so should use Schedulability 100.</p> <p>(Visit B3) Warning (Orbit Planner): VISIBILITY OVERRUN</p> <p>(Primary Exposure 1 (Prime + Parallel Group 1-2 in Visit B3)) Warning (Form): Light from the flash may escape from WFC3 and possibly contaminate exposures in other SIs.</p> <p>(Primary Exposure 3 (Prime + Parallel Group 3-4 in Visit B3)) Warning (Form): Light from the flash may escape from WFC3 and possibly contaminate exposures in other SIs.</p> <p>(Primary Exposure 5 (Prime + Parallel Group 5-6 in Visit B3)) Warning (Form): Light from the flash may escape from WFC3 and possibly contaminate exposures in other SIs.</p> <p>(Primary Exposure 7 (Prime + Parallel Group 7-8 in Visit B3)) Warning (Form): Light from the flash may escape from WFC3 and possibly contaminate exposures in other SIs.</p> <p>(Primary Exposure 9 (Prime + Parallel Group 9-10 in Visit B3)) Warning (Form): Light from the flash may escape from WFC3 and possibly contaminate exposures in other SIs.</p> <p>(Primary Exposure 11 (Prime + Parallel Group 11-12 in Visit B3)) Warning (Form): Light from the flash may escape from WFC3 and possibly contaminate exposures in other SIs.</p> <p>(Primary Exposure 13 (Prime + Parallel Group 13-14 in Visit B3)) Warning (Form): Light from the flash may escape from WFC3 and possibly contaminate exposures in other SIs.</p> <p>(Primary Exposure 15 (Prime + Parallel Group 15-16 in Visit B3)) Warning (Form): Light from the flash may escape from WFC3 and possibly contaminate exposures in other SIs.</p>					
Fixed Targets		#	Name	Target Coordinates	Targ. Coord. Corrections	Fluxes	Miscellaneous
		(1)	MACS0416-2403	RA: 04 16 8.3800 (64.0349167d) Dec: -24 04 20.80 (-24.07244d) Equinox: J2000		V=15	Reference Frame: ICRS
		(4)	MACS0416-ACSPAR2	RA: 04 16 8.3800 (64.0349167d) Dec: -24 04 20.80 (-24.07244d) Equinox: J2000		V=15	Reference Frame: ICRS

Proposal 12459 - Visit B3 - Through a Lens, Darkly - New Constraints on the Fundamental Components of the Cosmos

Exposures	#	Label	Target	Config,Mode,Aperture	Spectral Els.	Opt. Params.	Special Reqs.	Groups	Exp. Time/[Actual Dur.]	Orbit
	1	(1) MACS0416-2403	WFC3/UVIS, ACCUM, UVIS-FIX	F390W	CR-SPLIT=NO; FLASH=9	POS TARG 0,0; GS ACQ SCENARI O.BASE1B3	Prime + Parallel Gro up 1-2 in Visit B3	600 Secs [==>457.0 Secs]	[1]	
	2	(4) MACS0416-ACS PAR2	ACS/WFC, ACCUM, WFC-FIX	F850LP			Prime + Parallel Gro up 1-2 in Visit B3	600 Secs [==>383.0 Secs]	[1]	
	3	(1) MACS0416-2403	WFC3/UVIS, ACCUM, UVIS-FIX	F390W	CR-SPLIT=NO; FLASH=9	POS TARG 0.0594,- 0.0552	Prime + Parallel Gro up 3-4 in Visit B3	600 Secs [==>699.0 Secs]	[1]	
	4	(4) MACS0416-ACS PAR2	ACS/WFC, ACCUM, WFC-FIX	F850LP			Prime + Parallel Gro up 3-4 in Visit B3	600 Secs [==>675.0 Secs]	[1]	
	5	(1) MACS0416-2403	WFC3/UVIS, ACCUM, UVIS-FIX	F275W	CR-SPLIT=NO; FLASH=10	POS TARG 0.1188,0 .06735	Prime + Parallel Gro up 5-6 in Visit B3	600 Secs [==>699.0 Secs]	[1]	
	6	(4) MACS0416-ACS PAR2	ACS/WFC, ACCUM, WFC-FIX	F850LP			Prime + Parallel Gro up 5-6 in Visit B3	600 Secs [==>698.0 Secs]	[1]	
	7	(1) MACS0416-2403	WFC3/UVIS, ACCUM, UVIS-FIX	F275W	CR-SPLIT=NO; FLASH=10	POS TARG -0.0594, 0.15395	Prime + Parallel Gro up 7-8 in Visit B3	600 Secs [==>482.0 Secs]	[1]	
	8	(4) MACS0416-ACS PAR2	ACS/WFC, ACCUM, WFC-FIX	F775W			Prime + Parallel Gro up 7-8 in Visit B3	600 Secs [==>337.0 Secs]	[1]	
	9	(1) MACS0416-2403	WFC3/UVIS, ACCUM, UVIS-FIX	F275W	CR-SPLIT=NO; FLASH=10	POS TARG 0,0	Prime + Parallel Gro up 9-10 in Visit B3	600 Secs [==>552.0 Secs]	[2]	
	10	(4) MACS0416-ACS PAR2	ACS/WFC, ACCUM, WFC-FIX	F850LP			Prime + Parallel Gro up 9-10 in Visit B3	600 Secs [==>502.0 Secs]	[2]	
	11	(1) MACS0416-2403	WFC3/UVIS, ACCUM, UVIS-FIX	F275W	CR-SPLIT=NO; FLASH=10	POS TARG 0.0594,- 0.0552	Prime + Parallel Gro up 11-12 in Visit B3	600 Secs [==>699.0 Secs]	[2]	
	12	(4) MACS0416-ACS PAR2	ACS/WFC, ACCUM, WFC-FIX	F850LP			Prime + Parallel Gro up 11-12 in Visit B3	600 Secs [==>675.0 Secs]	[2]	
	13	(1) MACS0416-2403	WFC3/UVIS, ACCUM, UVIS-FIX	F275W	CR-SPLIT=NO; FLASH=10	POS TARG 0.1188,0 .06735	Prime + Parallel Gro up 13-14 in Visit B3	600 Secs [==>699.0 Secs]	[2]	
	14	(4) MACS0416-ACS PAR2	ACS/WFC, ACCUM, WFC-FIX	F850LP			Prime + Parallel Gro up 13-14 in Visit B3	600 Secs [==>675.0 Secs]	[2]	
	15	(1) MACS0416-2403	WFC3/UVIS, ACCUM, UVIS-FIX	F275W	CR-SPLIT=NO; FLASH=10	POS TARG -0.0594, 0.15395	Prime + Parallel Gro up 15-16 in Visit B3	600 Secs [==>553.0 Secs]	[2]	
16	(4) MACS0416-ACS PAR2	ACS/WFC, ACCUM, WFC-FIX	F775W			Prime + Parallel Gro up 15-16 in Visit B3	600 Secs [==>408.0 Secs]	[2]		

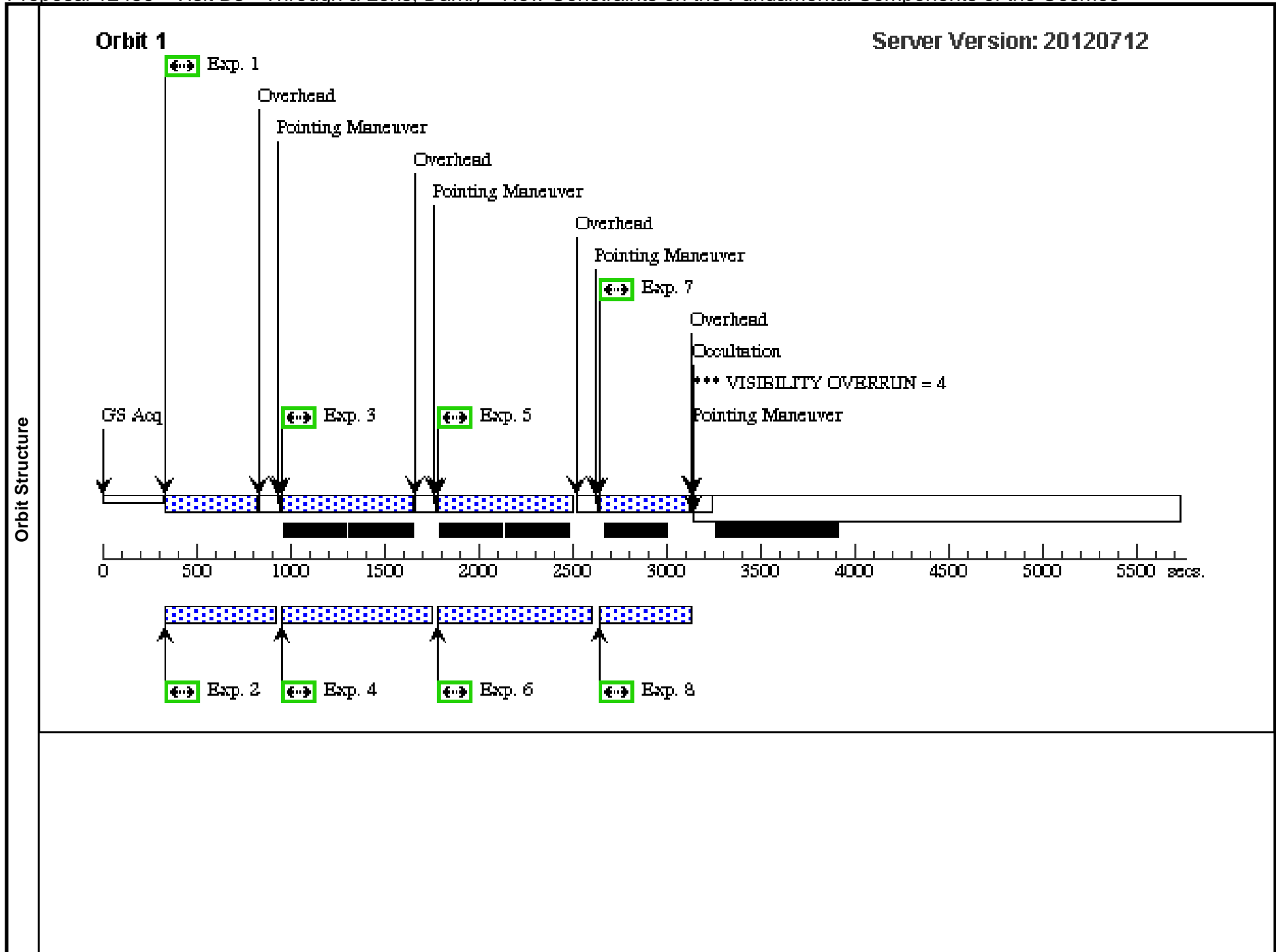

Orbit 2

Server Version: 20120712

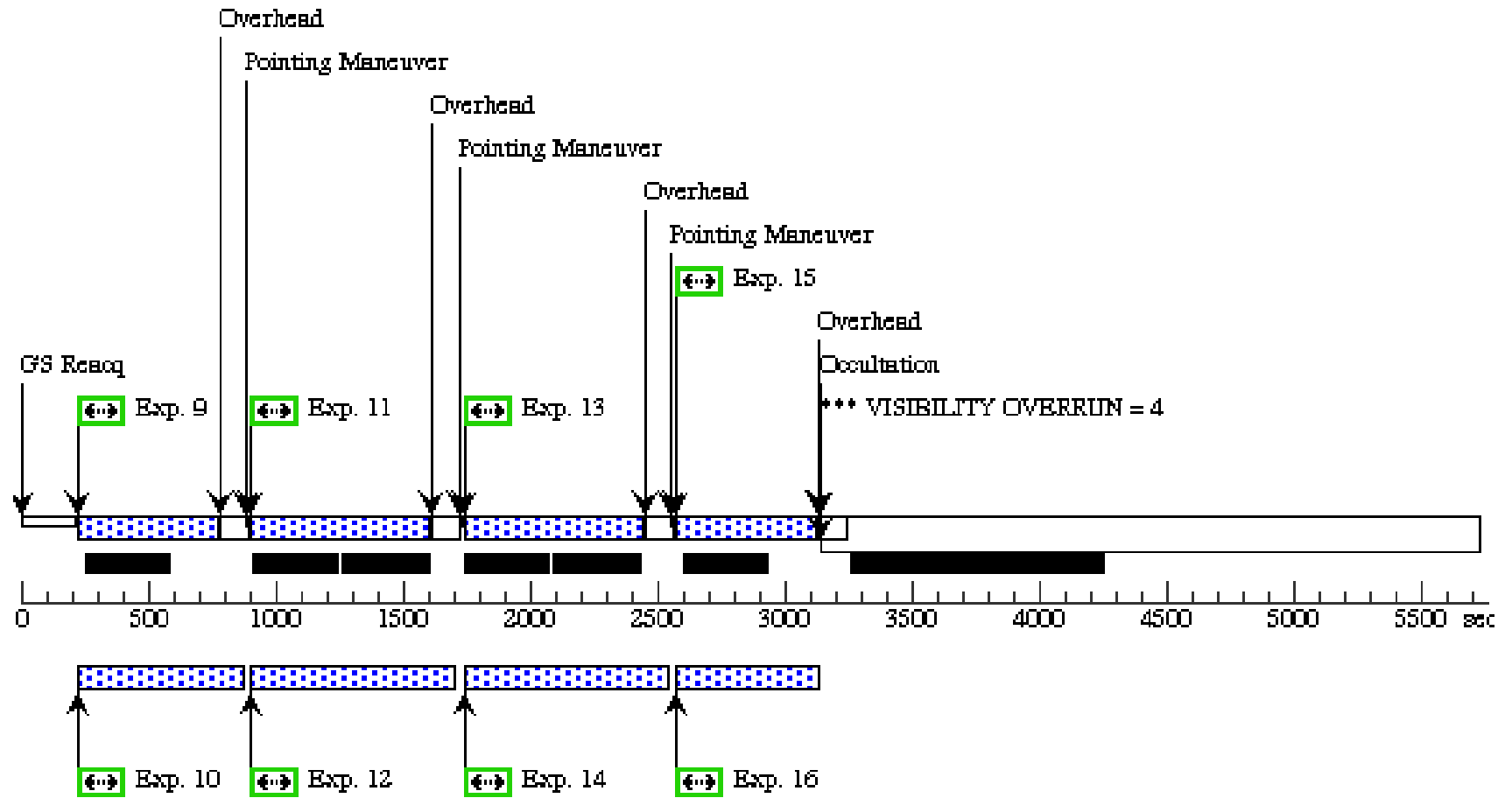

Proposal 12459 - Visit B5 - Through a Lens, Darkly - New Constraints on the Fundamental Components of the Cosmos

Tue Aug 14 01:16:43 GMT 2012

Visit	Proposal 12459, Visit B5, scheduling Diagnostic Status: Warning Scientific Instruments: WFC3/IR, WFC3/UVIS, ACS/WFC Special Requirements: SCHED 60%; SAME ORIENT AS B0; AFTER B0 BY 25 D TO 27 D <i>Comments: Visits B5-B6 represent epoch 3 (at orient 2) and should be taken concurrently</i>									
	Diagnosics (Visit B5) Warning (Orbit Planner): VISIBILITY OVERRUN (Visit B5) Warning (Form): The proposal is part of a large program (100 orbits or more in one cycle) and so should use Schedulability 100.									
Fixed Targets	#	Name	Target Coordinates	Targ. Coord. Corrections	Fluxes	Miscellaneous				
	(1)	MACS0416-2403	RA: 04 16 8.3800 (64.0349167d) Dec: -24 04 20.80 (-24.07244d) Equinox: J2000		V=15	Reference Frame: ICRS				
(5)	MACS0416-WFC3PAR2	RA: 04 16 8.3800 (64.0349167d) Dec: -24 04 20.80 (-24.07244d) Equinox: J2000		V=15	Reference Frame: ICRS					
Exposures	#	Label	Target	Config,Mode,Aperture	Spectral Els.	Opt. Params.	Special Reqs.	Groups	Exp. Time/[Actual Dur.]	Orbit
	1	(1) MACS0416-2403	ACS/WFC, ACCUM, WFC-FIX	F814W			POS TARG 0,0; GS ACQ SCENARI O BASE1B3	Prime + Parallel Group 1-2 in Visit B5	525 Secs [==>525 Secs]	[1]
	2	(5) MACS0416-WF C3PAR2	WFC3/IR, MULTIACCUM, IR-FIX	F125W		SAMP-SEQ=SPARS 100; NSAMP=8		Prime + Parallel Group 1-2 in Visit B5	[==>]	[1]
	3	(1) MACS0416-2403	ACS/WFC, ACCUM, WFC-FIX	F814W			POS TARG 0.3211,0 .7917	Prime + Parallel Group 3-4 in Visit B5	507 Secs [==>507.0 Secs]	[1]
	4	(5) MACS0416-WF C3PAR2	WFC3/IR, MULTIACCUM, IR-FIX	F160W		SAMP-SEQ=SPARS 50; NSAMP=13		Prime + Parallel Group 3-4 in Visit B5	[==>]	[1]
	5	(1) MACS0416-2403	ACS/WFC, ACCUM, WFC-FIX	F435W			POS TARG 1.0868,0 .5573	Prime + Parallel Group 5-6 in Visit B5	551 Secs [==>486 Secs]	[1]
	6	(5) MACS0416-WF C3PAR2	WFC3/IR, MULTIACCUM, IR-FIX	F160W		SAMP-SEQ=SPARS 100; NSAMP=7		Prime + Parallel Group 5-6 in Visit B5	[==>]	[1]
	7	(1) MACS0416-2403	ACS/WFC, ACCUM, WFC-FIX	F435W			POS TARG -0.3211, -0.1742	Prime + Parallel Group 7-8 in Visit B5	564 Secs [==>534 Secs]	[1]
	8	(5) MACS0416-WF C3PAR2	WFC3/UVIS, ACCUM, UVIS-FIX	F350LP		CR-SPLIT=NO		Prime + Parallel Group 7-8 in Visit B5	400 Secs [==>628 Secs]	[1]

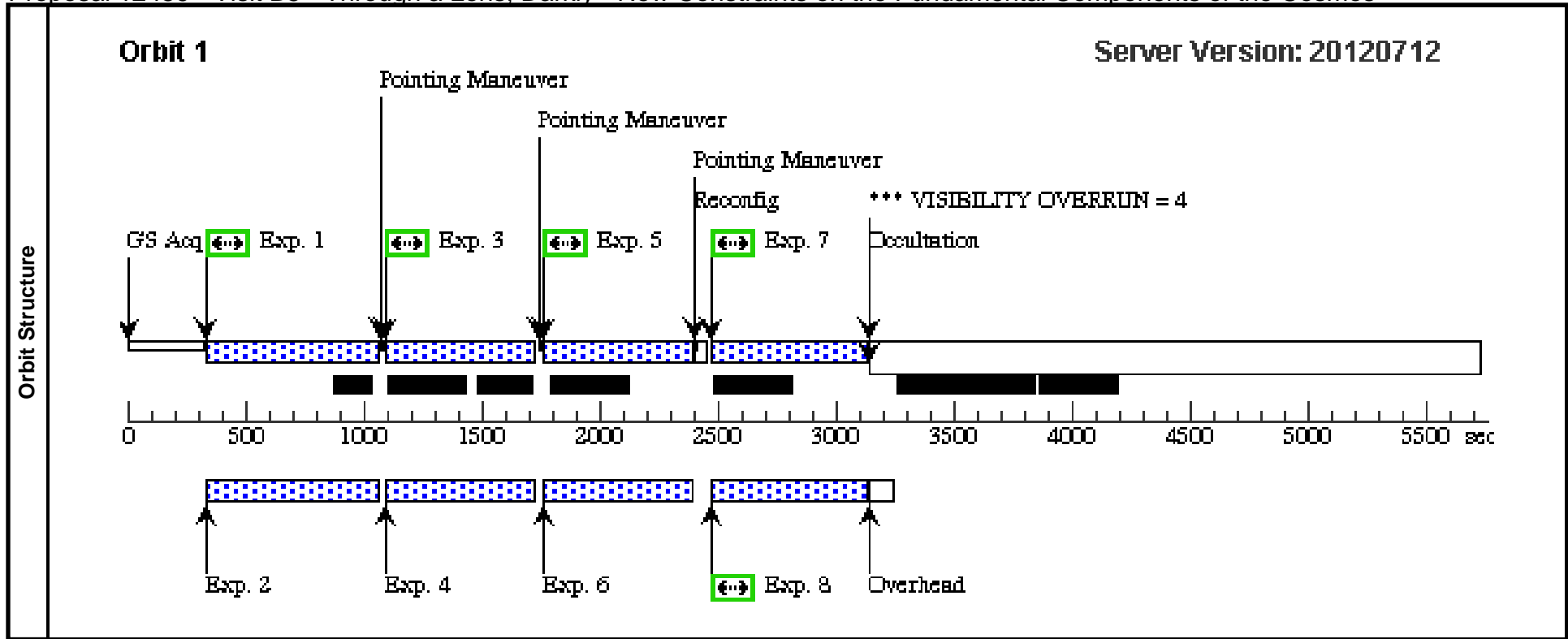

Proposal 12459 - Visit B6 - Through a Lens, Darkly - New Constraints on the Fundamental Components of the Cosmos

Tue Aug 14 01:16:44 GMT 2012

Visit	Proposal 12459, Visit B6, scheduling Diagnostic Status: Warning Scientific Instruments: WFC3/IR, WFC3/UVIS, ACS/WFC Special Requirements: SCHED 60%; SAME ORIENT AS B0; SEQ B5,B6 WITHIN 1.2 Orbits <i>Comments: Visits B5-B6 represent epoch 3 (at orient 2) and should be taken concurrently</i>					
	Diagnosics (Visit B6) Warning (Orbit Planner): PARALLELS SIGNIFICANTLY EXTEND ALIGNMENT TIME (Visit B6) Warning (Form): The proposal is part of a large program (100 orbits or more in one cycle) and so should use Schedulability 100. (Visit B6) Warning (Orbit Planner): VISIBILITY OVERRUN (Visit B6) Warning (Orbit Planner): VISIBILITY OVERRUN (Primary Exposure 1 (Prime + Parallel Group 1-2 in Visit B6)) Warning (Form): Light from the flash may escape from WFC3 and possibly contaminate exposures in other SIs. (Primary Exposure 3 (Prime + Parallel Group 3-4 in Visit B6)) Warning (Form): Light from the flash may escape from WFC3 and possibly contaminate exposures in other SIs. (Primary Exposure 5 (Prime + Parallel Group 5-6 in Visit B6)) Warning (Form): Light from the flash may escape from WFC3 and possibly contaminate exposures in other SIs. (Primary Exposure 7 (Prime + Parallel Group 7-8 in Visit B6)) Warning (Form): Light from the flash may escape from WFC3 and possibly contaminate exposures in other SIs.					
Fixed Targets	#	Name	Target Coordinates	Targ. Coord. Corrections	Fluxes	Miscellaneous
	(1)	MACS0416-2403	RA: 04 16 8.3800 (64.0349167d) Dec: -24 04 20.80 (-24.07244d) Equinox: J2000		V=15	Reference Frame: ICRS
	(4)	MACS0416-ACSPAR2	RA: 04 16 8.3800 (64.0349167d) Dec: -24 04 20.80 (-24.07244d) Equinox: J2000		V=15	Reference Frame: ICRS

Proposal 12459 - Visit B6 - Through a Lens, Darkly - New Constraints on the Fundamental Components of the Cosmos

Exposures	#	Label	Target	Config,Mode,Aperture	Spectral Els.	Opt. Params.	Special Reqs.	Groups	Exp. Time/[Actual Dur.]	Orbit
	1		(1) MACS0416-2403	WFC3/UVIS, ACCUM, UVIS-FIX	F336W	CR-SPLIT=NO; FLASH=10	POS TARG 0,0; GS ACQ SCENARI O BASE1B3	Prime + Parallel Group 1-2 in Visit B6	600 Secs [==>480.0 Secs]	[1]
	2		(4) MACS0416-ACS PAR2	ACS/WFC, ACCUM, WFC-FIX	F850LP			Prime + Parallel Group 1-2 in Visit B6	600 Secs [==>406.0 Secs]	[1]
	3		(1) MACS0416-2403	WFC3/UVIS, ACCUM, UVIS-FIX	F336W	CR-SPLIT=NO; FLASH=10	POS TARG 0.0594,- 0.0552	Prime + Parallel Group 3-4 in Visit B6	600 Secs [==>699.0 Secs]	[1]
	4		(4) MACS0416-ACS PAR2	ACS/WFC, ACCUM, WFC-FIX	F850LP			Prime + Parallel Group 3-4 in Visit B6	600 Secs [==>675.0 Secs]	[1]
	5		(1) MACS0416-2403	WFC3/UVIS, ACCUM, UVIS-FIX	F336W	CR-SPLIT=NO; FLASH=10	POS TARG 0.1188,0 .06735	Prime + Parallel Group 5-6 in Visit B6	600 Secs [==>699.0 Secs]	[1]
	6		(4) MACS0416-ACS PAR2	ACS/WFC, ACCUM, WFC-FIX	F850LP			Prime + Parallel Group 5-6 in Visit B6	600 Secs [==>675.0 Secs]	[1]
	7		(1) MACS0416-2403	WFC3/UVIS, ACCUM, UVIS-FIX	F336W	CR-SPLIT=NO; FLASH=10	POS TARG -0.0594, 0.15395	Prime + Parallel Group 7-8 in Visit B6	600 Secs [==>482.0 Secs]	[1]
	8		(4) MACS0416-ACS PAR2	ACS/WFC, ACCUM, WFC-FIX	F775W			Prime + Parallel Group 7-8 in Visit B6	600 Secs [==>337.0 Secs]	[1]
	9		(1) MACS0416-2403	WFC3/IR, MULTIACCUM, IR-FIX	F140W	SAMP-SEQ=SPARS 100; NSAMP=8	POS TARG 0,0	Prime + Parallel Group 9-10 in Visit B6	[==>]	[2]
	10		(4) MACS0416-ACS PAR2	ACS/WFC, ACCUM, WFC-FIX	F850LP			Prime + Parallel Group 9-10 in Visit B6	525 Secs [==>581.0 Secs]	[2]
	11		(1) MACS0416-2403	WFC3/IR, MULTIACCUM, IR-FIX	F140W	SAMP-SEQ=SPARS 100; NSAMP=7	POS TARG -1.1517 5.042385	Prime + Parallel Group 11-12 in Visit B6	[==>]	[2]
	12		(4) MACS0416-ACS PAR2	ACS/WFC, ACCUM, WFC-FIX	F850LP			Prime + Parallel Group 11-12 in Visit B6	607 Secs [==>507.0 Secs]	[2]
	13		(1) MACS0416-2403	WFC3/IR, MULTIACCUM, IR-FIX	F105W	SAMP-SEQ=SPARS 100; NSAMP=8	POS TARG -0.813,- 0.30275	Prime + Parallel Group 13-14 in Visit B6	[==>]	[2]
	14		(4) MACS0416-ACS PAR2	ACS/WFC, ACCUM, WFC-FIX	F850LP			Prime + Parallel Group 13-14 in Visit B6	481 Secs [==>607 Secs]	[2]
	15		(1) MACS0416-2403	WFC3/IR, MULTIACCUM, IR-FIX	F105W	SAMP-SEQ=SPARS 100; NSAMP=7	POS TARG 0.33875, -0.1211	Prime + Parallel Group 15-16 in Visit B6	[==>]	[2]
16		(4) MACS0416-ACS PAR2	ACS/WFC, ACCUM, WFC-FIX	F775W			Prime + Parallel Group 15-16 in Visit B6	576 Secs [==>565 Secs]	[2]	

Orbit 1

Server Version: 20120712

Orbit Structure

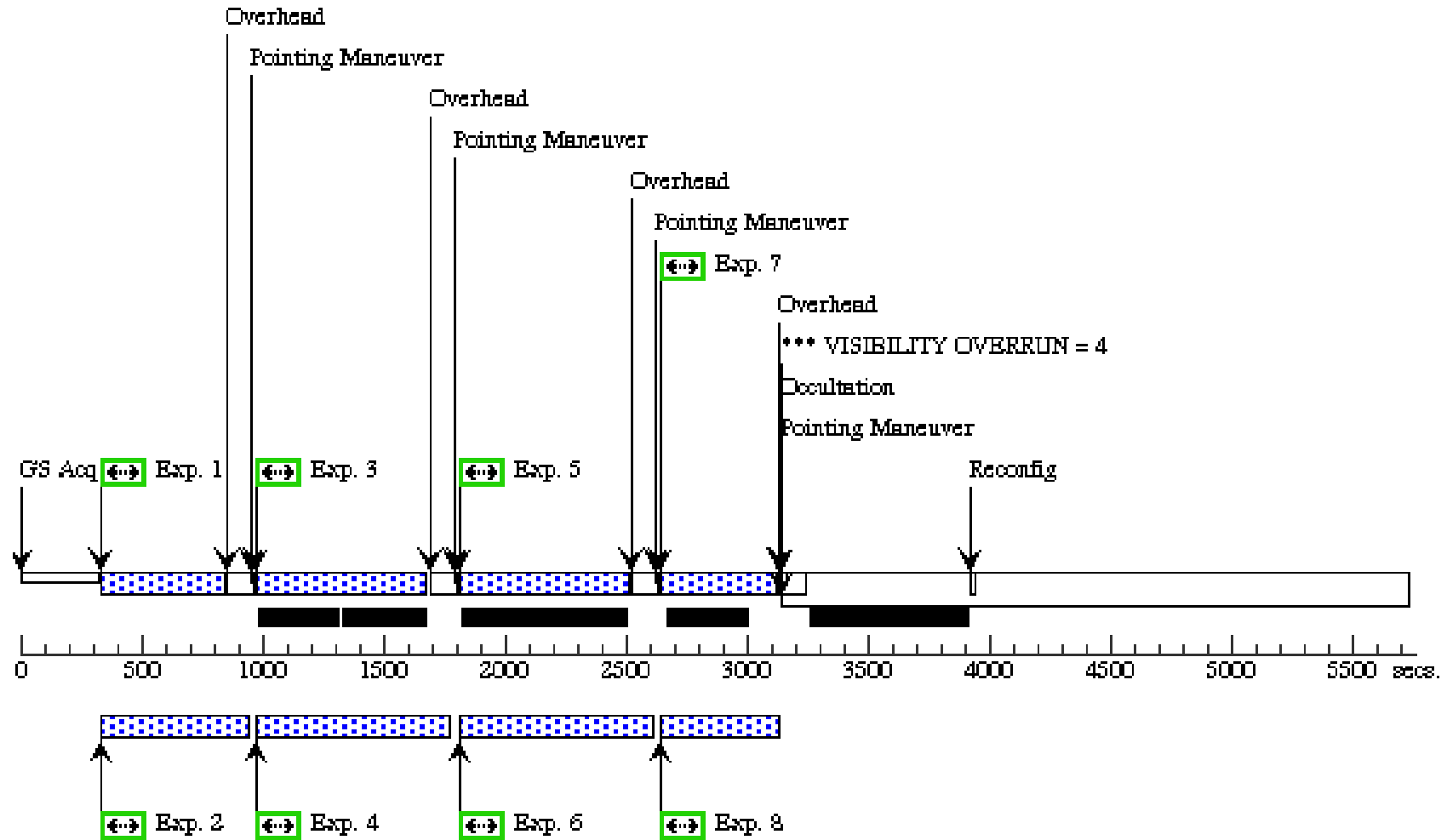

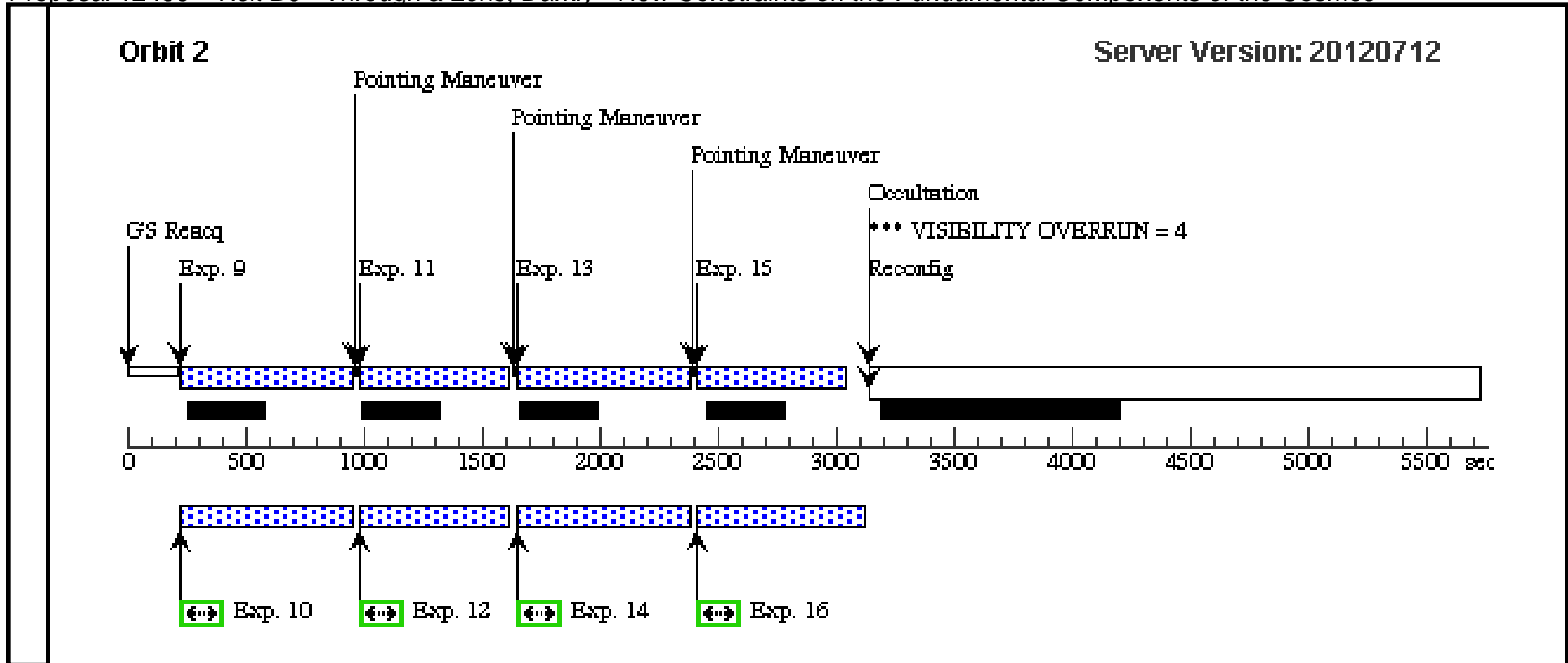

Proposal 12459 - Visit B7 - Through a Lens, Darkly - New Constraints on the Fundamental Components of the Cosmos

Tue Aug 14 01:16:47 GMT 2012

Visit	Proposal 12459, Visit B7, scheduling Diagnostic Status: Warning Scientific Instruments: WFC3/IR, WFC3/UVIS, ACS/WFC Special Requirements: SCHED 60%; SAME ORIENT AS B0; AFTER B0 BY 38 D TO 40 D <i>Comments: Visits B7-B8 represent epoch 4 (at orient 2) and should be taken concurrently</i>									
	Diagnostics	(Visit B7) Warning (Orbit Planner): VISIBILITY OVERRUN (Visit B7) Warning (Form): The proposal is part of a large program (100 orbits or more in one cycle) and so should use Schedulability 100.								
Fixed Targets		#	Name	Target Coordinates	Targ. Coord. Corrections	Fluxes	Miscellaneous			
	(1)	MACS0416-2403	RA: 04 16 8.3800 (64.0349167d) Dec: -24 04 20.80 (-24.07244d) Equinox: J2000		V=15	Reference Frame: ICRS				
(5)	MACS0416-WFC3PAR2	RA: 04 16 8.3800 (64.0349167d) Dec: -24 04 20.80 (-24.07244d) Equinox: J2000		V=15	Reference Frame: ICRS					
Exposures	#	Label	Target	Config,Mode,Aperture	Spectral Els.	Opt. Params.	Special Reqs.	Groups	Exp. Time/[Actual Dur.]	Orbit
	1		(1) MACS0416-2403	ACS/WFC, ACCUM, WFC-FIX	F475W		POS TARG 0,0; GS ACQ SCENARI O BASE1B3	Prime + Parallel Group 1-2 in Visit B7	525 Secs [==>525 Secs]	[1]
	2		(5) MACS0416-WF C3PAR2	WFC3/IR, MULTIACCUM, IR-FIX	F125W	SAMP-SEQ=SPARS 100; NSAMP=8		Prime + Parallel Group 1-2 in Visit B7	[==>]	[1]
	3		(1) MACS0416-2403	ACS/WFC, ACCUM, WFC-FIX	F475W		POS TARG 0.3211,0 .7917	Prime + Parallel Group 3-4 in Visit B7	507 Secs [==>507.0 Secs]	[1]
	4		(5) MACS0416-WF C3PAR2	WFC3/IR, MULTIACCUM, IR-FIX	F160W	SAMP-SEQ=SPARS 50; NSAMP=13		Prime + Parallel Group 3-4 in Visit B7	[==>]	[1]
	5		(1) MACS0416-2403	ACS/WFC, ACCUM, WFC-FIX	F850LP		POS TARG 1.0868,0 .5573	Prime + Parallel Group 5-6 in Visit B7	551 Secs [==>469.0 Secs]	[1]
	6		(5) MACS0416-WF C3PAR2	WFC3/IR, MULTIACCUM, IR-FIX	F160W	SAMP-SEQ=SPARS 100; NSAMP=7		Prime + Parallel Group 5-6 in Visit B7	[==>]	[1]
	7		(1) MACS0416-2403	ACS/WFC, ACCUM, WFC-FIX	F850LP		POS TARG -0.3211, -0.1742	Prime + Parallel Group 7-8 in Visit B7	564 Secs [==>534 Secs]	[1]
	8		(5) MACS0416-WF C3PAR2	WFC3/UVIS, ACCUM, UVIS-FIX	F350LP	CR-SPLIT=NO		Prime + Parallel Group 7-8 in Visit B7	400 Secs [==>628 Secs]	[1]

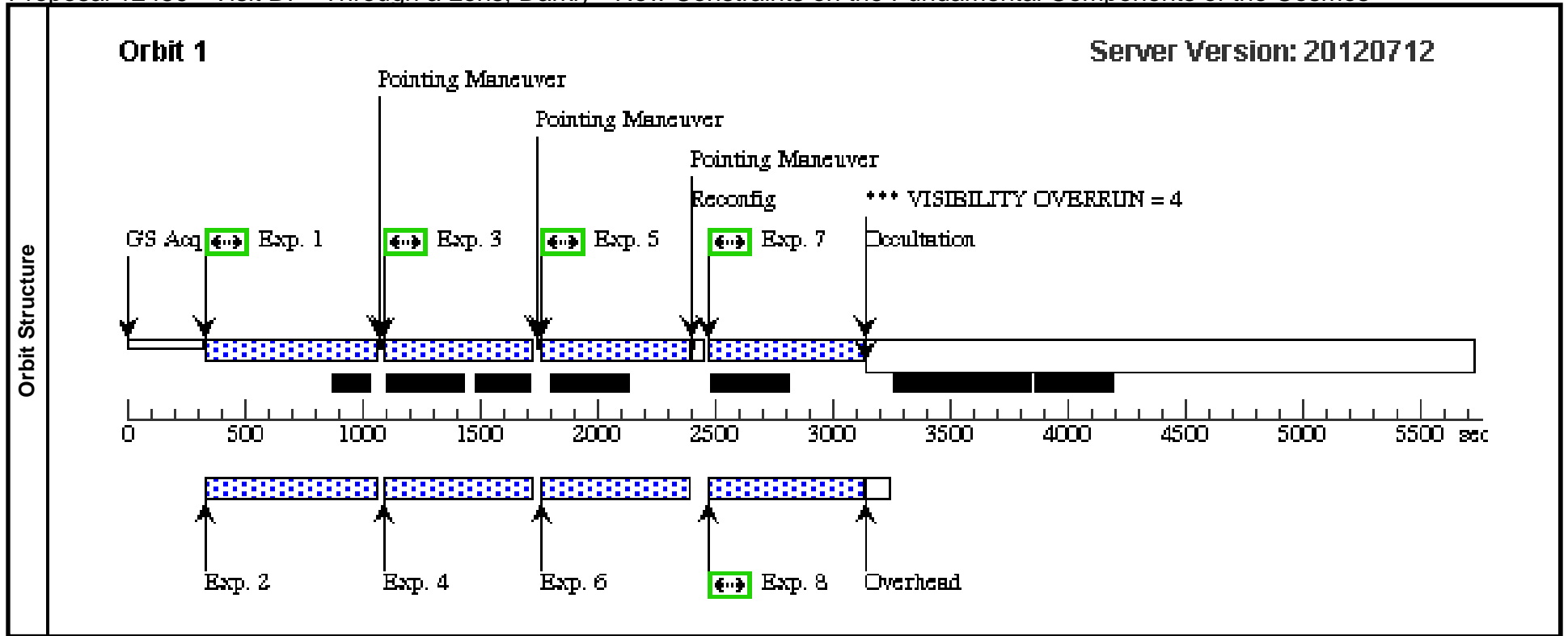

Proposal 12459 - Visit B8 - Through a Lens, Darkly - New Constraints on the Fundamental Components of the Cosmos

Tue Aug 14 01:16:48 GMT 2012

Visit	Proposal 12459, Visit B8, scheduling Diagnostic Status: Warning Scientific Instruments: WFC3/IR, ACS/WFC Special Requirements: SCHED 60%; SAME ORIENT AS B0; SEQ B7,B8 WITHIN 1.2 Orbits <i>Comments: Visits B7-B8 represent epoch 4 (at orient 2) and should be taken concurrently</i>									
	Diagnostics	(Visit B8) Warning (Orbit Planner): VISIBILITY OVERRUN (Visit B8) Warning (Form): The proposal is part of a large program (100 orbits or more in one cycle) and so should use Schedulability 100.								
Fixed Targets		#	Name	Target Coordinates	Targ. Coord. Corrections	Fluxes	Miscellaneous			
	(1)	MACS0416-2403	RA: 04 16 8.3800 (64.0349167d) Dec: -24 04 20.80 (-24.07244d) Equinox: J2000		V=15	Reference Frame: ICRS				
(4)	MACS0416-ACSPAR2	RA: 04 16 8.3800 (64.0349167d) Dec: -24 04 20.80 (-24.07244d) Equinox: J2000		V=15	Reference Frame: ICRS					
Exposures	#	Label	Target	Config,Mode,Aperture	Spectral Els.	Opt. Params.	Special Reqs.	Groups	Exp. Time/[Actual Dur.]	Orbit
	1		(1) MACS0416-2403	WFC3/IR, MULTIACCUM, IR-FIX	F160W	SAMP-SEQ=SPARS 100; NSAMP=6	POS TARG 0,0; GS ACQ SCENARI O BASE1B3	Prime + Parallel Gro up 1-2 in Visit B8	[==>]	[1]
	2		(4) MACS0416-ACS PAR2	ACS/WFC, ACCUM, WFC-FIX	F850LP			Prime + Parallel Gro up 1-2 in Visit B8	525 Secs [==>325.0 Secs]	[1]
	3		(1) MACS0416-2403	WFC3/IR, MULTIACCUM, IR-FIX	F160W	SAMP-SEQ=SPARS 100; NSAMP=6	POS TARG -1.1517 5,0.42385	Prime + Parallel Gro up 3-4 in Visit B8	[==>]	[1]
	4		(4) MACS0416-ACS PAR2	ACS/WFC, ACCUM, WFC-FIX	F850LP			Prime + Parallel Gro up 3-4 in Visit B8	607 Secs [==>407 Secs]	[1]
	5		(1) MACS0416-2403	WFC3/IR, MULTIACCUM, IR-FIX	F160W	SAMP-SEQ=SPARS 100; NSAMP=6	POS TARG -0.813,- 0.30275	Prime + Parallel Gro up 5-6 in Visit B8	[==>]	[1]
	6		(4) MACS0416-ACS PAR2	ACS/WFC, ACCUM, WFC-FIX	F850LP			Prime + Parallel Gro up 5-6 in Visit B8	582 Secs [==>407 Secs]	[1]
	7		(1) MACS0416-2403	WFC3/IR, MULTIACCUM, IR-FIX	F125W	SAMP-SEQ=SPARS 100; NSAMP=6	POS TARG 0.33875, -0.1211	Prime + Parallel Gro up 7-8 in Visit B8	[==>]	[1]
	8		(4) MACS0416-ACS PAR2	ACS/WFC, ACCUM, WFC-FIX	F850LP			Prime + Parallel Gro up 7-8 in Visit B8	587 Secs [==>407.0 Secs]	[1]
	9		(1) MACS0416-2403	WFC3/IR, MULTIACCUM, IR-FIX	F125W	SAMP-SEQ=SPARS 100; NSAMP=6	POS TARG -0.813,- 0.30275	Prime + Parallel Gro up 9-10 in Visit B8	[==>]	[1]
10		(4) MACS0416-ACS PAR2	ACS/WFC, ACCUM, WFC-FIX	F775W			Prime + Parallel Gro up 9-10 in Visit B8	587 Secs [==>389 Secs]	[1]	

