



14429 - MAMA Spectroscopic Sensitivity and Focus Monitor Cycle 23

Cycle: 23, Proposal Category: CAL/STIS

(Calibration)

(Availability Mode: RESTRICTED)

INVESTIGATORS

<i>Name</i>	<i>Institution</i>	<i>E-Mail</i>
Dr. Tala Wanda R Monroe (PI) (Contact)	Space Telescope Science Institute	tmonroe@stsci.edu
Dr. Charles R. Proffitt (CoI)	Space Telescope Science Institute	proffitt@stsci.edu
Sean Lockwood (CoI)	Space Telescope Science Institute	lockwood@stsci.edu

VISITS

<i>Visit</i>	<i>Targets used in Visit</i>	<i>Configurations used in Visit</i>	<i>Orbits Used</i>	<i>Last Orbit Planner Run</i>	<i>OP Current with Visit?</i>
L1	(1) GRW+70D5824 NONE WAVE	STIS STIS/CCD STIS/FUV-MAMA STIS/NUV-MAMA	1	07-Sep-2016 17:27:08.0	yes
L2	(1) GRW+70D5824 NONE WAVE	STIS STIS/CCD STIS/FUV-MAMA STIS/NUV-MAMA	1	07-Sep-2016 17:27:11.0	yes
L3	(1) GRW+70D5824 NONE WAVE	STIS STIS/CCD STIS/FUV-MAMA STIS/NUV-MAMA	1	07-Sep-2016 17:27:12.0	yes

Proposal 14429 (STScI Edit Number: 4, Created: Wednesday, September 7, 2016 4:27:23 PM EST) - Overview

<i>Visit</i>	<i>Targets used in Visit</i>	<i>Configurations used in Visit</i>	<i>Orbits Used</i>	<i>Last Orbit Planner Run</i>	<i>OP Current with Visit?</i>
L4	(1) GRW+70D5824 NONE WAVE	STIS STIS/CCD STIS/FUV-MAMA STIS/NUV-MAMA	1	07-Sep-2016 17:27:14.0	yes
M1	(2) AGK+81D266 NONE	STIS STIS/CCD STIS/FUV-MAMA STIS/NUV-MAMA	1	07-Sep-2016 17:27:15.0	yes
E1	(3) BD+28D4211 ANY	COS/FUV STIS/CCD STIS/FUV-MAMA STIS/NUV-MAMA	2	07-Sep-2016 17:27:17.0	yes
E2	(3) BD+28D4211 ANY	COS/FUV STIS/CCD STIS/FUV-MAMA STIS/NUV-MAMA	2	07-Sep-2016 17:27:18.0	yes
E3	(3) BD+28D4211 ANY	COS/FUV STIS/CCD STIS/FUV-MAMA STIS/NUV-MAMA	2	07-Sep-2016 17:27:20.0	yes
E4	(3) BD+28D4211 ANY	COS/FUV STIS/CCD STIS/FUV-MAMA STIS/NUV-MAMA	2	07-Sep-2016 17:27:22.0	yes

13 Total Orbits Used

ABSTRACT

Monitor sensitivity of each MAMA grating mode to detect any change due to contamination or other causes. Also monitor the STIS focus in a spectroscopic and an

imaging mode.

Obtain exposures in each of the 2 low-resolution MAMA spectroscopic modes every 4 months, in each of the 2 medium-resolution modes once a year, and in each of the 5 echelle modes every 3 months, using unique calibration standards for each mode, and ratio the results to the first observations to detect any trends. In addition, each L-mode sequence will be preceded by a CCD/F28X50OII image, two spectroscopic ACQ/PEAKs with the CCD/G230LB and crossed linear patterns, and two CCD/G230LB spectra, with the purpose of measuring the focus (PSF across the dispersion as a function of UV wavelength); and each M-mode sequence will be preceded by a CCD/F28X50OII direct image also to monitor the focus.

Whenever possible (together with E visits), obtain parallel airglow spectra with COS.

OBSERVING DESCRIPTION

Obtain exposures in each of the 2 low-resolution MAMA spectroscopic modes every 4 months, in each of the 2 medium-resolution modes once a year, and in each of the 5 echelle modes every 3 months, using unique calibration standards for each mode, and ratio the results to the first observations to detect any trends. In addition, each L-mode sequence will be preceded by a CCD/F28X50OII image, two spectroscopic ACQ/PEAKs with the CCD/G230LB and crossed linear patterns, and two CCD/G230LB spectra, with the purpose of measuring the focus (PSF across the dispersion as a function of UV wavelength); and each M-mode sequence will be preceded by a CCD/F28X50OII direct image also to monitor the focus.

Whenever possible (together with E visits), obtain parallel airglow spectra with COS.

----- Additional Comments -----

Interim reports and ISR on sensitivity monitor. Wavelength-dependent trends for implementation as pipeline corrections. ISR on focus monitors. If the focus quality is found to degrade significantly, a separate program to take corrective action (such as an adjustment of the STIS tip/tilt mirror) may be implemented.

COS Observations of Geocoronal Lyman-alpha Emission

Proposal 14429 (STScI Edit Number: 4, Created: Wednesday, September 7, 2016 4:27:23 PM EST) - Overview

In parallel with STIS observations of BD+28D4211, perform coordinated parallel observations of the background sky with COS. G130M 1291 and 1327 should be used instead of 1300 so that OI line does not fall in the segment gap.

Use only one of the two orbits in each visit to avoid alignment problems.

These observations are almost identical to the Cycle 19 STIS calibration program 12775. The echelle exposure times in visits E1, E2, E3, and E4 have been changed slightly to fit in orbits. The COS configurations for the COS parallel observations have been changed slightly.

----- Additional C23 Comments -----

xxx Better focus monitor data for STIS. xxx

The original spec was tied to the G230LB throughput with the 0.1X0.09, but TDS and CTI effects complicate comparison to the original observations they did after the initial fine-focus sweep.

Includes G230LB ACCUM observations with both 0.1X0.09 and 52x2 (approximately repeating the original calibration), and also an OII image which can be used to get the absolute focus of the CCD detector via phase retrieval. G230LB 50CCD was changed to G230LB 52x2 for Cycle 23.

To squeeze all this in while staying within a single 100% schedulable orbit, G230L wave cal was moved after the external exposure so it goes into the occultation (change was first implemented for cycle 22). See visit LF in the attached APT draft.

M visit: changed 'centeraxis2' to 'sizeaxis2'.

xxx Update to Geocoronal xxx

- Using visits E3 and E4 for 1291, and E1 and E2 for 1327.

xxx Overall change: ETC computation updates; Small ExpTime adjustment to fit within orbits

----- Changes to L visits -----

Proposal 14429 (STScI Edit Number: 4, Created: Wednesday, September 7, 2016 4:27:23 PM EST) - Overview

Made some additional changes to improve the focus monitoring to match L3 from Cycle 22 and to make it more consistent with 14063

Changed peakups from 7 X 20 mas in each AXIS to 5 X 75 (AXIS2) and 5 X 69 (AXIS1)

Increased peakup exposure time from 1 s to 2 s per dwell point

Increased ACQ exposure time from 0.1 s to 3 s (ETC calc referenced was for wrong star)

Increased total OII exposure time from 10 s to 110 s and changed gain from 1 to 4

No changes to MAMA exposures

Proposal 14429 - Visit L1 - MAMA Spectroscopic Sensitivity and Focus Monitor Cycle 23

Wed Sep 07 21:27:23 GMT 2016

Visit	Proposal 14429, Visit L1, completed Diagnostic Status: No Diagnostics Scientific Instruments: STIS/NUV-MAMA, STIS/CCD, STIS, STIS/FUV-MAMA Special Requirements: SCHED 100%; BETWEEN 02-NOV-2015:00:00:00 AND 16-NOV-2015:00:00:00 Comments: <i>L-modes + Focus</i> Please schedule this visit in an SAA-free block if possible.					
	Fixed Targets	#	Name	Target Coordinates	Targ. Coord. Corrections	Fluxes
(1)		GRW+70D5824	RA: 13 38 51.1700 (204.7132083d) Dec: +70 17 7.85 (70.28551d) Equinox: J2000	Proper Motion RA: -0.0798 sec of time/yr Proper Motion Dec: -0.0262 arcsec/yr Epoch of Position: 1991.25	V=12.77+/-0.0 B-V = -0.09 F(1280.8) = 1.38 +/- 0.1 E-12	Reference Frame: ICRS

Proposal 14429 - Visit L1 - MAMA Spectroscopic Sensitivity and Focus Monitor Cycle 23

#	Label (ETC Run)	Target	Config,Mode,Aperture	Spectral Els.	Opt. Params.	Special Reqs.	Groups	Exp. Time (Total)/[Actual Dur.]	Orbit
1	ACQ (STIS.ta.712 465)	(1) GRW+70D5824	STIS/CCD, ACQ, F28X50LP	MIRROR		GS ACQ SCENARI O BASE1B3		3 Secs (3 Secs) [==>]	[1]
<i>Comments: Updated exposure time and ETC reference. Old referenced ETC calculation had been using the wrong star.</i>									
2	OII (STIS.im.63 2527)	(1) GRW+70D5824	STIS/CCD, ACCUM, F28X50OII	MIRROR	GAIN=4; CR-SPLIT=2; SIZEAXIS2=128			110 Secs (110 Secs) [==>(Split 1)] [==>(Split 2)]	[1]
3	Peak (STIS.ta.712 309)	(1) GRW+70D5824	STIS/CCD, ACQ/PEAK, 0.1X0.09	MIRROR	STEP-SIZE=75; NUM-POS=5; SEARCH=LINEAR AXIS2			2 Secs (2 Secs) [==>]	[1]
4	Peak (STIS.ta.712 309)	(1) GRW+70D5824	STIS/CCD, ACQ/PEAK, 0.1X0.09	MIRROR	STEP-SIZE=69; NUM-POS=5; SEARCH=LINEAR AXIS1			2 Secs (2 Secs) [==>]	[1]
5	G230LB 0.1 X0.09 (STIS.sp.63 2531)	(1) GRW+70D5824	STIS/CCD, ACCUM, 0.1X0.09	G230LB 2375 A	CR-SPLIT=2; SIZEAXIS2=64; WAVECAL=NO; GAIN=1			100 Secs (100 Secs) [==>(Split 1)] [==>(Split 2)]	[1]
6	G230LB 52 x2 (STIS.sp.63 2531)	(1) GRW+70D5824	STIS/CCD, ACCUM, 52X2	G230LB 2375 A	CR-SPLIT=2; SIZEAXIS2=64; WAVECAL=NO; GAIN=1			86 Secs (86 Secs) [==>(Split 1)] [==>(Split 2)]	[1]
7	SETOFFSE T=ZERO	NONE	STIS, MSMOFF		SETOFFSET=ZERO ; GRATING1=ALL			[==>]	[1]
8	G140L WA VE	WAVE	STIS/FUV-MAMA, ACCUM, 52X0.05	G140L 1425 A				[==>]	[1]
9	G140L (STIS.sp.63 6596)	(1) GRW+70D5824	STIS/FUV-MAMA, ACCUM, 52X2	G140L 1425 A				331.0 Secs (331 Secs) [==>]	[1]
10	G230L (STIS.sp.63 6595)	(1) GRW+70D5824	STIS/NUV-MAMA, ACCUM, 52X2	G230L 2376 A				368.0 Secs (368 Secs) [==>]	[1]
<i>Comments: Expand</i>									
11	G230L WA VE	WAVE	STIS/NUV-MAMA, ACCUM, 31X0.05NDC	G230L 2376 A				[==>]	[1]
12	SETOFFSE T=RESTOR E	NONE	STIS, MSMOFF		SETOFFSET=REST ORE; GRATING1=ALL			[==>]	[1]

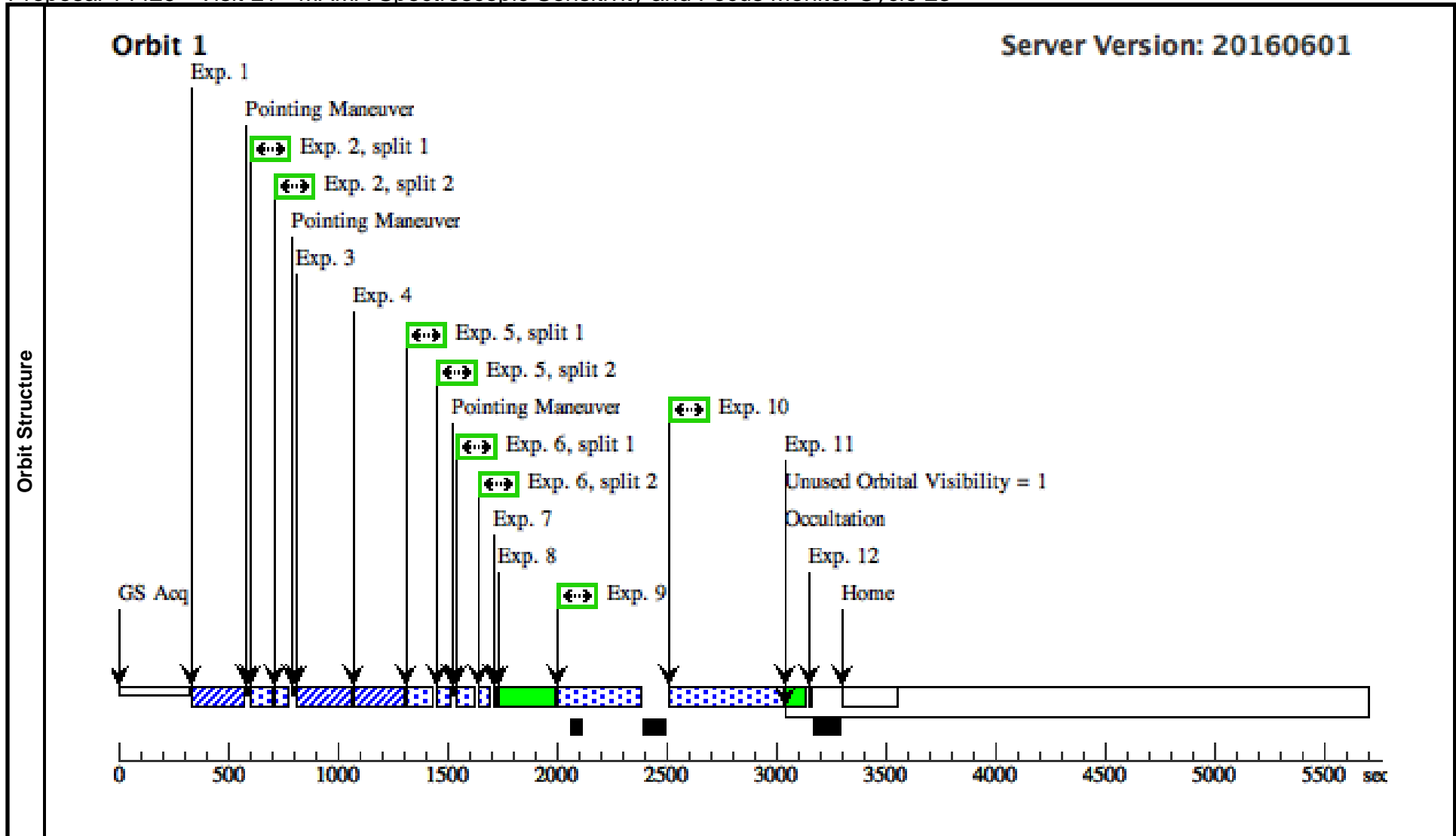

Proposal 14429 - Visit L2 - MAMA Spectroscopic Sensitivity and Focus Monitor Cycle 23

Wed Sep 07 21:27:24 GMT 2016

Visit	<p>Proposal 14429, Visit L2, completed</p> <p>Diagnostic Status: No Diagnostics</p> <p>Scientific Instruments: STIS/NUV-MAMA, STIS/CCD, STIS, STIS/FUV-MAMA</p> <p>Special Requirements: SCHED 100%; BETWEEN 07-MAR-2016:00:00:00 AND 21-MAR-2016:00:00:00</p> <p><i>Comments: L-modes + Focus</i></p> <p><i>Please schedule this visit in an SAA-free block if possible.</i></p>					
	Fixed Targets	#	Name	Target Coordinates	Targ. Coord. Corrections	Fluxes
	(1)	GRW+70D5824	RA: 13 38 51.1700 (204.7132083d) Dec: +70 17 7.85 (70.28551d) Equinox: J2000	Proper Motion RA: -0.0798 sec of time/yr Proper Motion Dec: -0.0262 arcsec/yr Epoch of Position: 1991.25	V=12.77+/-0.0 B-V =-0.09 F(1280.8) = 1.38 +/- 0.1 E-12	Reference Frame: ICRS

Proposal 14429 - Visit L2 - MAMA Spectroscopic Sensitivity and Focus Monitor Cycle 23

#	Label (ETC Run)	Target	Config,Mode,Aperture	Spectral Els.	Opt. Params.	Special Reqs.	Groups	Exp. Time (Total)/[Actual Dur.]	Orbit
1	ACQ (STIS.ta.712 465)	(1) GRW+70D5824	STIS/CCD, ACQ, F28X50LP	MIRROR		GS ACQ SCENARI O BASE1B3		3 Secs (3 Secs) [==>]	[1]
<i>Comments: Updated exposure time and ETC reference. Old referenced ETC calculation had been using the wrong star.</i>									
2	OII (STIS.im.63 2527)	(1) GRW+70D5824	STIS/CCD, ACCUM, F28X50OII	MIRROR	GAIN=4; CR-SPLIT=2; SIZEAXIS2=128			110 Secs (110 Secs) [==>(Split 1)] [==>(Split 2)]	[1]
3	Peak (STIS.ta.712 309)	(1) GRW+70D5824	STIS/CCD, ACQ/PEAK, 0.1X0.09	MIRROR	STEP-SIZE=75; NUM-POS=5; SEARCH=LINEAR AXIS2			2 Secs (2 Secs) [==>]	[1]
4	Peak (STIS.ta.712 309)	(1) GRW+70D5824	STIS/CCD, ACQ/PEAK, 0.1X0.09	MIRROR	STEP-SIZE=69; NUM-POS=5; SEARCH=LINEAR AXIS1			2 Secs (2 Secs) [==>]	[1]
5	G230LB 0.1 X0.09 (STIS.sp.63 2531)	(1) GRW+70D5824	STIS/CCD, ACCUM, 0.1X0.09	G230LB 2375 A	CR-SPLIT=2; SIZEAXIS2=64; WAVECAL=NO; GAIN=1			100 Secs (100 Secs) [==>(Split 1)] [==>(Split 2)]	[1]
6	G230LB 52 x2 (STIS.sp.63 2531)	(1) GRW+70D5824	STIS/CCD, ACCUM, 52X2	G230LB 2375 A	CR-SPLIT=2; SIZEAXIS2=64; WAVECAL=NO; GAIN=1			86 Secs (86 Secs) [==>(Split 1)] [==>(Split 2)]	[1]
7	SETOFFSE T=ZERO	NONE	STIS, MSMOFF		SETOFFSET=ZERO ; GRATING1=ALL			[==>]	[1]
8	G140L WA VE	WAVE	STIS/FUV-MAMA, ACCUM, 52X0.05	G140L 1425 A				[==>]	[1]
9	G140L (STIS.sp.63 6596)	(1) GRW+70D5824	STIS/FUV-MAMA, ACCUM, 52X2	G140L 1425 A				331.0 Secs (331 Secs) [==>]	[1]
10	G230L (STIS.sp.63 6595)	(1) GRW+70D5824	STIS/NUV-MAMA, ACCUM, 52X2	G230L 2376 A				368.0 Secs (368 Secs) [==>]	[1]
<i>Comments: Expand</i>									
11	G230L WA VE	WAVE	STIS/NUV-MAMA, ACCUM, 31X0.05NDC	G230L 2376 A				[==>]	[1]
12	SETOFFSE T=RESTOR E	NONE	STIS, MSMOFF		SETOFFSET=REST ORE; GRATING1=ALL			[==>]	[1]

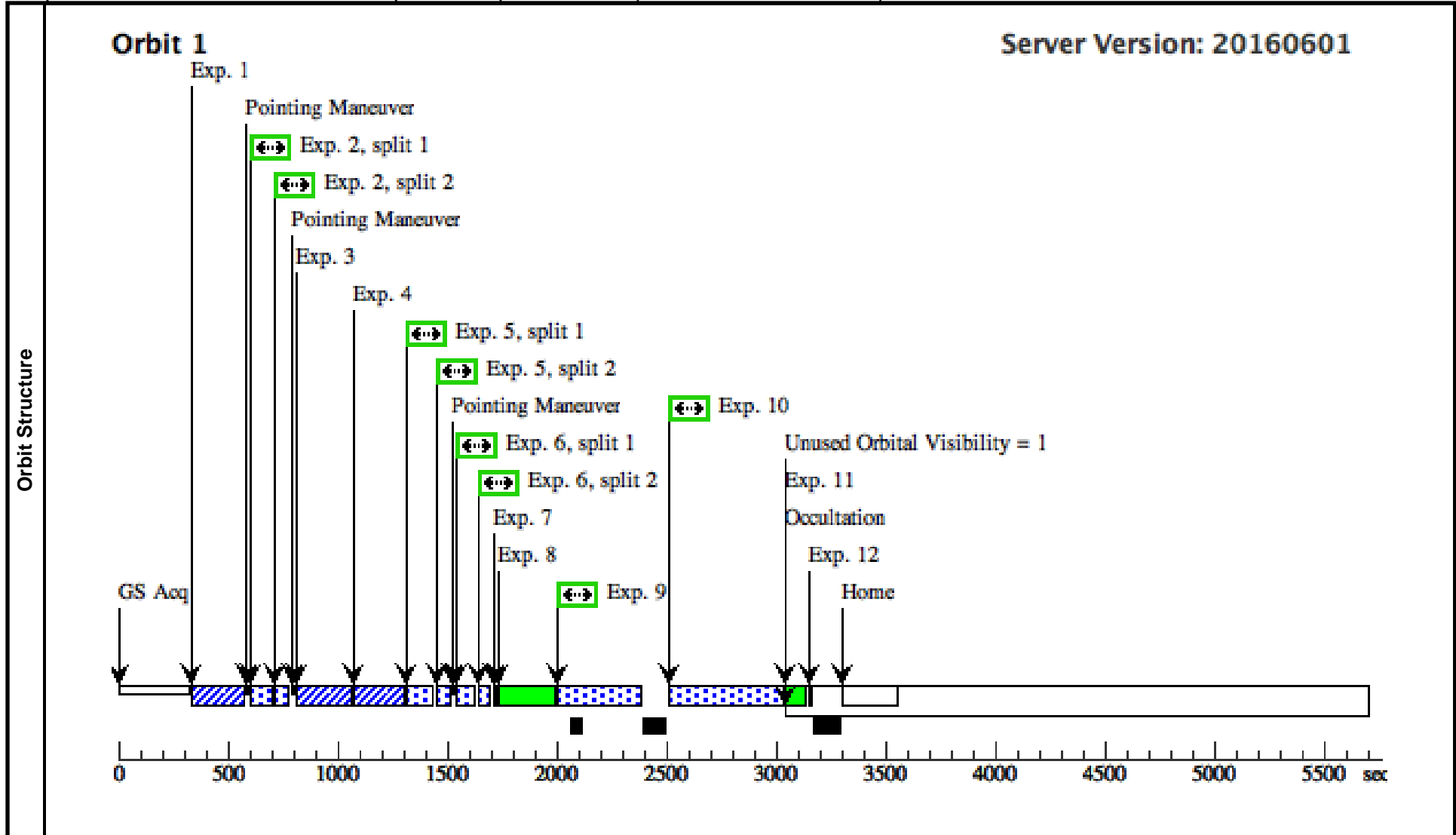

Proposal 14429 - Visit L3 - MAMA Spectroscopic Sensitivity and Focus Monitor Cycle 23

Wed Sep 07 21:27:24 GMT 2016

Visit	<p>Proposal 14429, Visit L3, failed</p> <p>Diagnostic Status: No Diagnostics</p> <p>Scientific Instruments: STIS/NUV-MAMA, STIS/CCD, STIS, STIS/FUV-MAMA</p> <p>Special Requirements: SCHED 100%; BETWEEN 04-JUL-2016:00:00:00 AND 18-JUL-2016:00:00:00</p> <p><i>Comments: L-modes + Focus</i></p> <p><i>Please schedule this visit in an SAA-free block if possible.</i></p>					
	Fixed Targets	#	Name	Target Coordinates	Targ. Coord. Corrections	Fluxes
(1)		GRW+70D5824	RA: 13 38 51.1700 (204.7132083d) Dec: +70 17 7.85 (70.28551d) Equinox: J2000	Proper Motion RA: -0.0798 sec of time/yr Proper Motion Dec: -0.0262 arcsec/yr Epoch of Position: 1991.25	V=12.77+/-0.0 B-V = -0.09 F(1280.8) = 1.38 +/- 0.1 E-12	Reference Frame: ICRS

Proposal 14429 - Visit L3 - MAMA Spectroscopic Sensitivity and Focus Monitor Cycle 23

#	Label (ETC Run)	Target	Config,Mode,Aperture	Spectral Els.	Opt. Params.	Special Reqs.	Groups	Exp. Time (Total)/[Actual Dur.]	Orbit
1	ACQ (STIS.ta.712 465)	(1) GRW+70D5824	STIS/CCD, ACQ, F28X50LP	MIRROR		GS ACQ SCENARI O BASE1B3		3 Secs (3 Secs) [==>]	[1]
<i>Comments: Updated exposure time and ETC reference. Old referenced ETC calculation had been using the wrong star.</i>									
2	OII (STIS.im.63 2527)	(1) GRW+70D5824	STIS/CCD, ACCUM, F28X50OII	MIRROR	GAIN=4; CR-SPLIT=2; SIZEAXIS2=128			110 Secs (110 Secs) [==>(Split 1)] [==>(Split 2)]	[1]
3	Peak (STIS.ta.712 309)	(1) GRW+70D5824	STIS/CCD, ACQ/PEAK, 0.1X0.09	MIRROR	STEP-SIZE=75; NUM-POS=5; SEARCH=LINEAR AXIS2			2 Secs (2 Secs) [==>]	[1]
4	Peak (STIS.ta.712 309)	(1) GRW+70D5824	STIS/CCD, ACQ/PEAK, 0.1X0.09	MIRROR	STEP-SIZE=69; NUM-POS=5; SEARCH=LINEAR AXIS1			2 Secs (2 Secs) [==>]	[1]
5	G230LB 0.1 X0.09 (STIS.sp.63 2531)	(1) GRW+70D5824	STIS/CCD, ACCUM, 0.1X0.09	G230LB 2375 A	CR-SPLIT=2; SIZEAXIS2=64; WAVECAL=NO; GAIN=1			100 Secs (100 Secs) [==>(Split 1)] [==>(Split 2)]	[1]
6	G230LB 52 x2 (STIS.sp.63 2531)	(1) GRW+70D5824	STIS/CCD, ACCUM, 52X2	G230LB 2375 A	CR-SPLIT=2; SIZEAXIS2=64; WAVECAL=NO; GAIN=1			86 Secs (86 Secs) [==>(Split 1)] [==>(Split 2)]	[1]
7	SETOFFSE T=ZERO	NONE	STIS, MSMOFF		SETOFFSET=ZERO ; GRATING1=ALL			[==>]	[1]
8	G140L WA VE	WAVE	STIS/FUV-MAMA, ACCUM, 52X0.05	G140L 1425 A				[==>]	[1]
9	G140L (STIS.sp.63 6596)	(1) GRW+70D5824	STIS/FUV-MAMA, ACCUM, 52X2	G140L 1425 A				331.0 Secs (331 Secs) [==>]	[1]
10	G230L (STIS.sp.63 6595)	(1) GRW+70D5824	STIS/NUV-MAMA, ACCUM, 52X2	G230L 2376 A				368.0 Secs (368 Secs) [==>]	[1]
<i>Comments: Expand</i>									
11	G230L WA VE	WAVE	STIS/NUV-MAMA, ACCUM, 31X0.05NDC	G230L 2376 A				[==>]	[1]
12	SETOFFSE T=RESTOR E	NONE	STIS, MSMOFF		SETOFFSET=REST ORE; GRATING1=ALL			[==>]	[1]

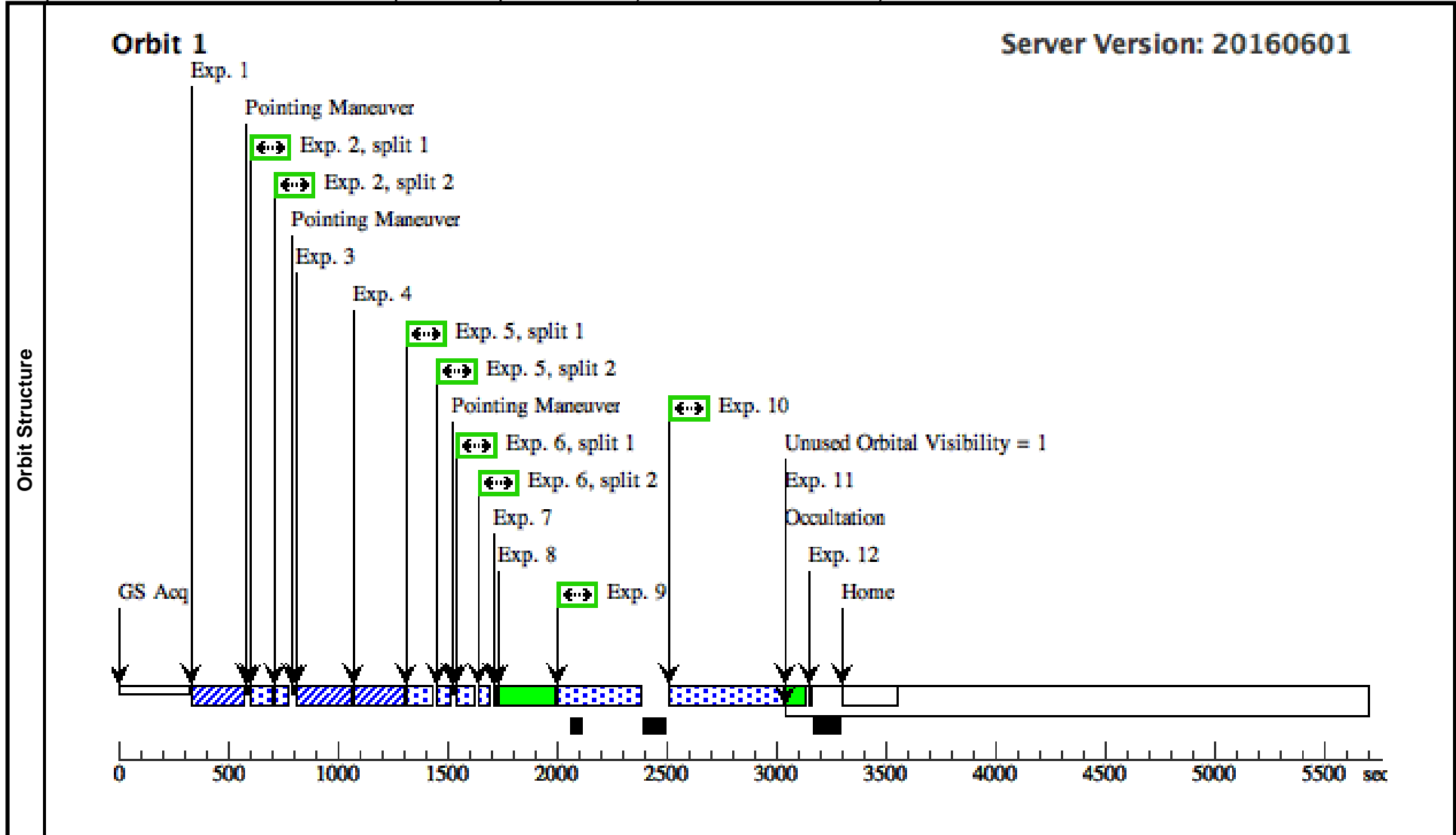

Proposal 14429 - Visit L4 - MAMA Spectroscopic Sensitivity and Focus Monitor Cycle 23

Wed Sep 07 21:27:24 GMT 2016

Visit	Proposal 14429, Visit L4, implementation Diagnostic Status: No Diagnostics Scientific Instruments: STIS/NUV-MAMA, STIS/CCD, STIS, STIS/FUV-MAMA Special Requirements: SCHED 100%; BETWEEN 08-SEP-2016:00:00:00 AND 15-SEP-2016:00:00:00 Comments: <i>L-modes + Focus</i> Please schedule this visit in an SAA-free block if possible.					
	Fixed Targets	#	Name	Target Coordinates	Targ. Coord. Corrections	Fluxes
	(1)	GRW+70D5824	RA: 13 38 51.1700 (204.7132083d) Dec: +70 17 7.85 (70.28551d) Equinox: J2000	Proper Motion RA: -0.0798 sec of time/yr Proper Motion Dec: -0.0262 arcsec/yr Epoch of Position: 1991.25	V=12.77+/-0.0 B-V = -0.09 F(1280.8) = 1.38 +/- 0.1 E-12	Reference Frame: ICRS

Proposal 14429 - Visit L4 - MAMA Spectroscopic Sensitivity and Focus Monitor Cycle 23

#	Label (ETC Run)	Target	Config,Mode,Aperture	Spectral Els.	Opt. Params.	Special Reqs.	Groups	Exp. Time (Total)/[Actual Dur.]	Orbit
1	ACQ (STIS.ta.712 465)	(1) GRW+70D5824	STIS/CCD, ACQ, F28X50LP	MIRROR		GS ACQ SCENARI O BASE1B3		3 Secs (3 Secs) [==>]	[1]
<i>Comments: Updated exposure time and ETC reference. Old referenced ETC calculation had been using the wrong star.</i>									
2	OII (STIS.im.63 2527)	(1) GRW+70D5824	STIS/CCD, ACCUM, F28X50OII	MIRROR	GAIN=4; CR-SPLIT=2; SIZEAXIS2=128			110 Secs (110 Secs) [==>(Split 1)] [==>(Split 2)]	[1]
3	Peak (STIS.ta.712 309)	(1) GRW+70D5824	STIS/CCD, ACQ/PEAK, 0.1X0.09	MIRROR	STEP-SIZE=75; NUM-POS=5; SEARCH=LINEAR AXIS2			2 Secs (2 Secs) [==>]	[1]
4	Peak (STIS.ta.712 309)	(1) GRW+70D5824	STIS/CCD, ACQ/PEAK, 0.1X0.09	MIRROR	STEP-SIZE=69; NUM-POS=5; SEARCH=LINEAR AXIS1			2 Secs (2 Secs) [==>]	[1]
5	G230LB 0.1 X0.09 (STIS.sp.63 2531)	(1) GRW+70D5824	STIS/CCD, ACCUM, 0.1X0.09	G230LB 2375 A	CR-SPLIT=2; SIZEAXIS2=64; WAVECAL=NO; GAIN=1			100 Secs (100 Secs) [==>(Split 1)] [==>(Split 2)]	[1]
6	G230LB 52 x2 (STIS.sp.63 2531)	(1) GRW+70D5824	STIS/CCD, ACCUM, 52X2	G230LB 2375 A	CR-SPLIT=2; SIZEAXIS2=64; WAVECAL=NO; GAIN=1			86 Secs (86 Secs) [==>(Split 1)] [==>(Split 2)]	[1]
7	SETOFFSE T=ZERO	NONE	STIS, MSMOFF		SETOFFSET=ZERO ; GRATING1=ALL			[==>]	[1]
8	G140L WA VE	WAVE	STIS/FUV-MAMA, ACCUM, 52X0.05	G140L 1425 A				[==>]	[1]
9	G140L (STIS.sp.63 6596)	(1) GRW+70D5824	STIS/FUV-MAMA, ACCUM, 52X2	G140L 1425 A				331.0 Secs (331 Secs) [==>]	[1]
10	G230L (STIS.sp.63 6595)	(1) GRW+70D5824	STIS/NUV-MAMA, ACCUM, 52X2	G230L 2376 A				368.0 Secs (368 Secs) [==>]	[1]
<i>Comments: Expand</i>									
11	G230L WA VE	WAVE	STIS/NUV-MAMA, ACCUM, 31X0.05NDC	G230L 2376 A				[==>]	[1]
12	SETOFFSE T=RESTOR E	NONE	STIS, MSMOFF		SETOFFSET=REST ORE; GRATING1=ALL			[==>]	[1]

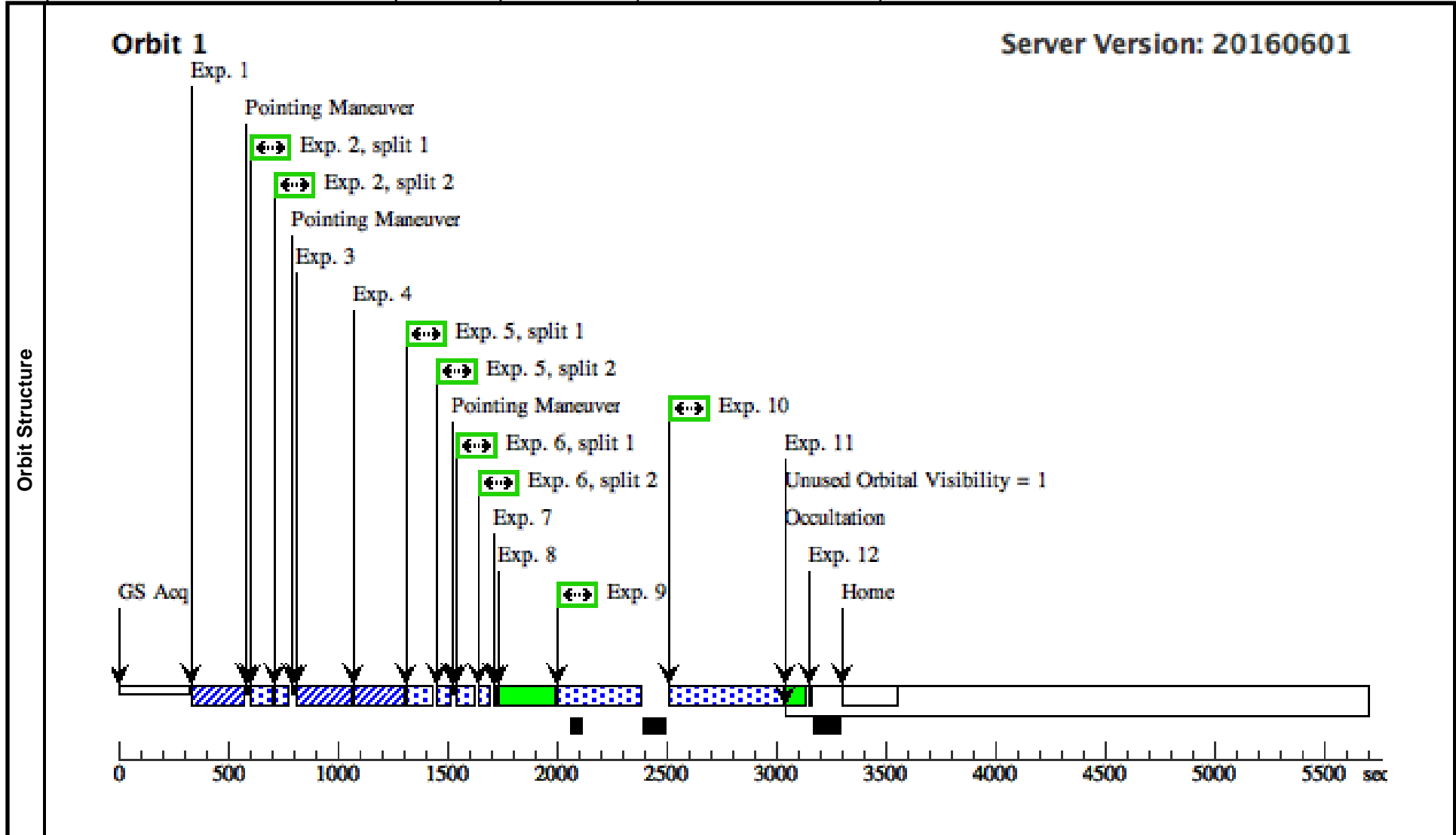

Proposal 14429 - Visit M1 - MAMA Spectroscopic Sensitivity and Focus Monitor Cycle 23

Wed Sep 07 21:27:24 GMT 2016

Visit	Proposal 14429, Visit M1, completed Diagnostic Status: No Diagnostics Scientific Instruments: STIS/NUV-MAMA, STIS/CCD, STIS, STIS/FUV-MAMA Special Requirements: BEFORE 01-FEB-2016:00:00:00 Comments: M-modes + Focus Please schedule this visit in an SAA-free block if possible.									
	Fixed Targets	#	Name	Target Coordinates	Targ. Coord. Corrections	Fluxes	Miscellaneous			
	(2)	AGK+81D266	RA: 09 21 19.2000 (140.3300000d) Dec: +81 43 28.08 (81.72447d) Equinox: J2000	Proper Motion RA: -0.0047 sec of time/yr Proper Motion Dec: -0.0501 arcsec/yr Epoch of Position: 1991.25	V=11.92+/-0.5 B-V = -0.33	Reference Frame: ICRS				
Exposures	#	Label (ETC Run)	Target	Config,Mode,Aperture	Spectral Els.	Opt. Params.	Special Reqs.	Groups	Exp. Time (Total)/[Actual Dur.]	Orbit
	1	ACQ (STIS.ta.636 593)	(2) AGK+81D266	STIS/CCD, ACQ, F28X50LP	MIRROR				.1 Secs (0.1 Secs) [==>]	[1]
	2	MSOFF zero	NONE	STIS, MSMOFF		SETOFFSET=ZERO ; GRATING1=ALL			[==>]	[1]
	3	OII image (STIS.im.20 4049)	(2) AGK+81D266	STIS/CCD, ACCUM, F28X50OII	MIRROR	GAIN=4; CR-SPLIT=2; SIZEAXIS2=256			90.0 Secs (90 Secs) [==>(Split 1)] [==>(Split 2)]	[1]
	4	G140M (STIS.sp.63 6602)	(2) AGK+81D266	STIS/FUV-MAMA, ACCUM, 52X2	G140M 1567 A				380.0 Secs (380 Secs) [==>]	[1]
	5	G140M (STIS.sp.63 661)	(2) AGK+81D266	STIS/FUV-MAMA, ACCUM, 52X2	G140M 1173 A				204.0 Secs (204 Secs) [==>]	[1]
	<i>Comments: Expand</i>									
	6	G230M (STIS.sp.63 6603)	(2) AGK+81D266	STIS/NUV-MAMA, ACCUM, 52X2	G230M 2818 A				480.0 Secs (480 Secs) [==>]	[1]
<i>Comments: Expand</i>										
7	MSOFF RESTORE	NONE	STIS, MSMOFF		SETOFFSET=RESTORE; GRATING1=ALL			[==>]	[1]	

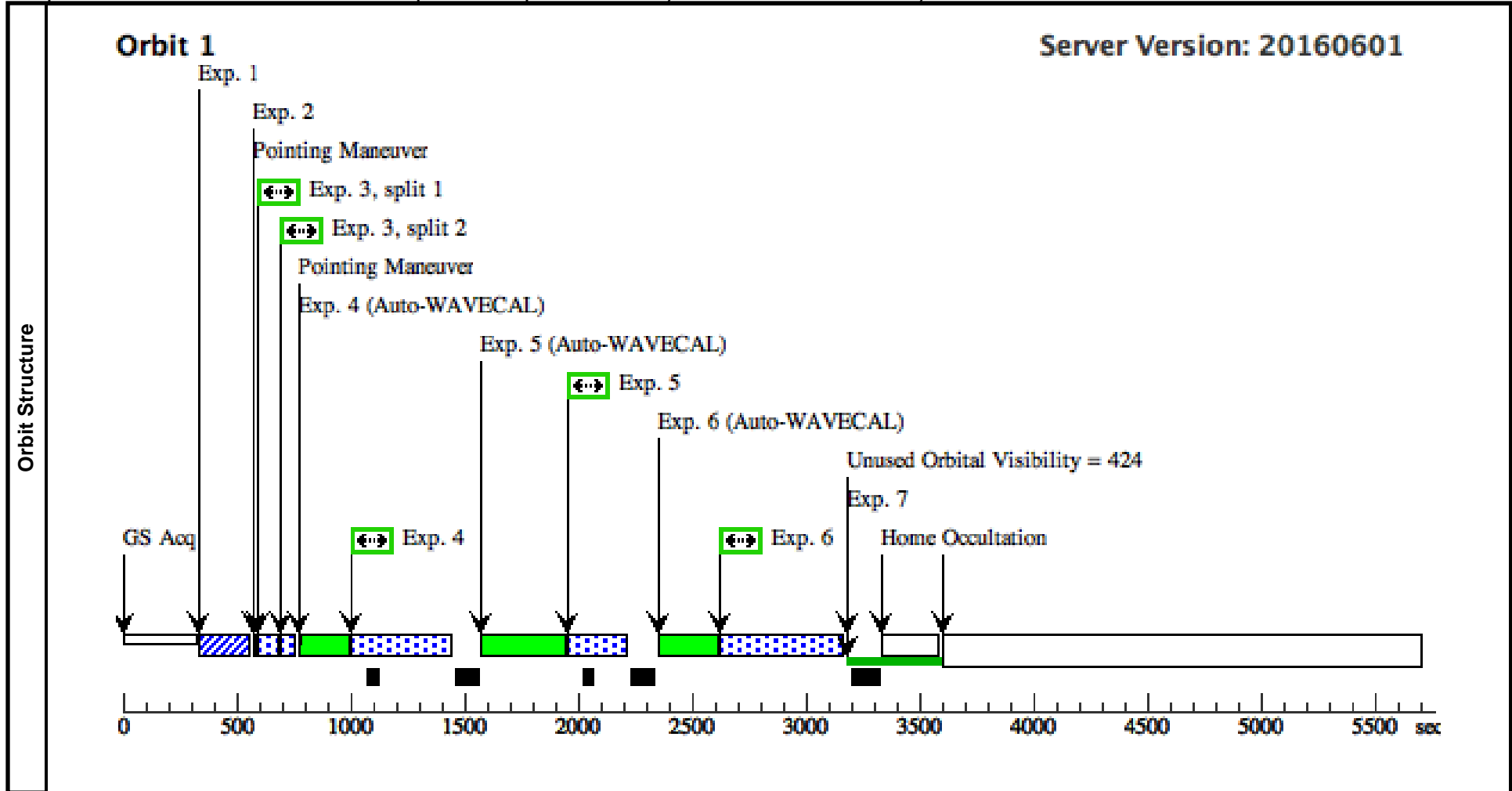

Proposal 14429 - Visit E1 - MAMA Spectroscopic Sensitivity and Focus Monitor Cycle 23

Wed Sep 07 21:27:24 GMT 2016

Visit	Proposal 14429, Visit E1, completed Diagnostic Status: Warning Scientific Instruments: STIS/NUV-MAMA, STIS/CCD, COS/FUV, STIS/FUV-MAMA Special Requirements: ORIENT 91D TO 96 D; BETWEEN 02-NOV-2015:00:00:00 AND 23-NOV-2015:00:00:00 Comments: E-modes + Focus Please schedule this visit in an SAA-free block if possible.									
	(Visit E1) Warning (Form): For the best data quality, it is strongly recommended that all four FP-POS positions be used when observing at a given COS CENWAVE setting.									
Fixed Targets	#	Name	Target Coordinates	Targ. Coord. Corrections	Fluxes	Miscellaneous				
	(3)	BD+28D4211	RA: 21 51 11.0200 (327.7959167d) Dec: +28 51 50.40 (28.86400d) Equinox: J2000	Proper Motion RA: -0.0026 sec of time/yr Proper Motion Dec: -0.056 arcsec/yr Epoch of Position: 2000.0	V=10.51+/-0.04 B-V = -0.34 F(2000)=9.42 +/- 0.001 e-12	Reference Frame: ICRS				
Exposures	#	Label (ETC Run)	Target	Config,Mode,Aperture	Spectral Els.	Opt. Params.	Special Reqs.	Groups	Exp. Time (Total)/[Actual Dur.]	Orbit
	1	ACQ (STIS.ta.636 593)	(3) BD+28D4211	STIS/CCD, ACQ, F28X50LP	MIRROR				0.1 Secs (0.1 Secs) [==>]	[1]
	2	E230H (STIS.sp.63 6584)	(3) BD+28D4211	STIS/NUV-MAMA, ACCUM, 0.2X0.2	E230H 2263 A				1732 Secs (1732 Secs) [==>]	[1]
	3	E140M (STIS.sp.63 6585)	(3) BD+28D4211	STIS/FUV-MAMA, ACCUM, 0.2X0.2	E140M 1425 A				346 Secs (346 Secs) [==>]	[1]
	4	E230M (STIS.sp.63 6592)	(3) BD+28D4211	STIS/NUV-MAMA, ACCUM, 0.2X0.2	E230M 1978 A			Prime + Parallel Group 4-7 in Visit E1	628 Secs (628 Secs) [==>]	[2]
	5	E140H (STIS.sp.63 6588)	(3) BD+28D4211	STIS/FUV-MAMA, ACCUM, 0.2X0.2	E140H 1416 A			Prime + Parallel Group 4-7 in Visit E1	1034 Secs (1034 Secs) [==>]	[2]
	6	E230M (STIS.sp.63 6589)	(3) BD+28D4211	STIS/NUV-MAMA, ACCUM, 0.2X0.2	E230M 2707 A			Prime + Parallel Group 4-7 in Visit E1	422.0 Secs (422 Secs) [==>]	[2]
	7	(COS.sp.745 935)	ANY	COS/FUV, TIME-TAG, PSA	G130M 1327 A		BUFFER-TIME=46 50; FP-POS=1	Prime + Parallel Group 4-7 in Visit E1	2900.0 Secs (2900 Secs) [==>]	[2]

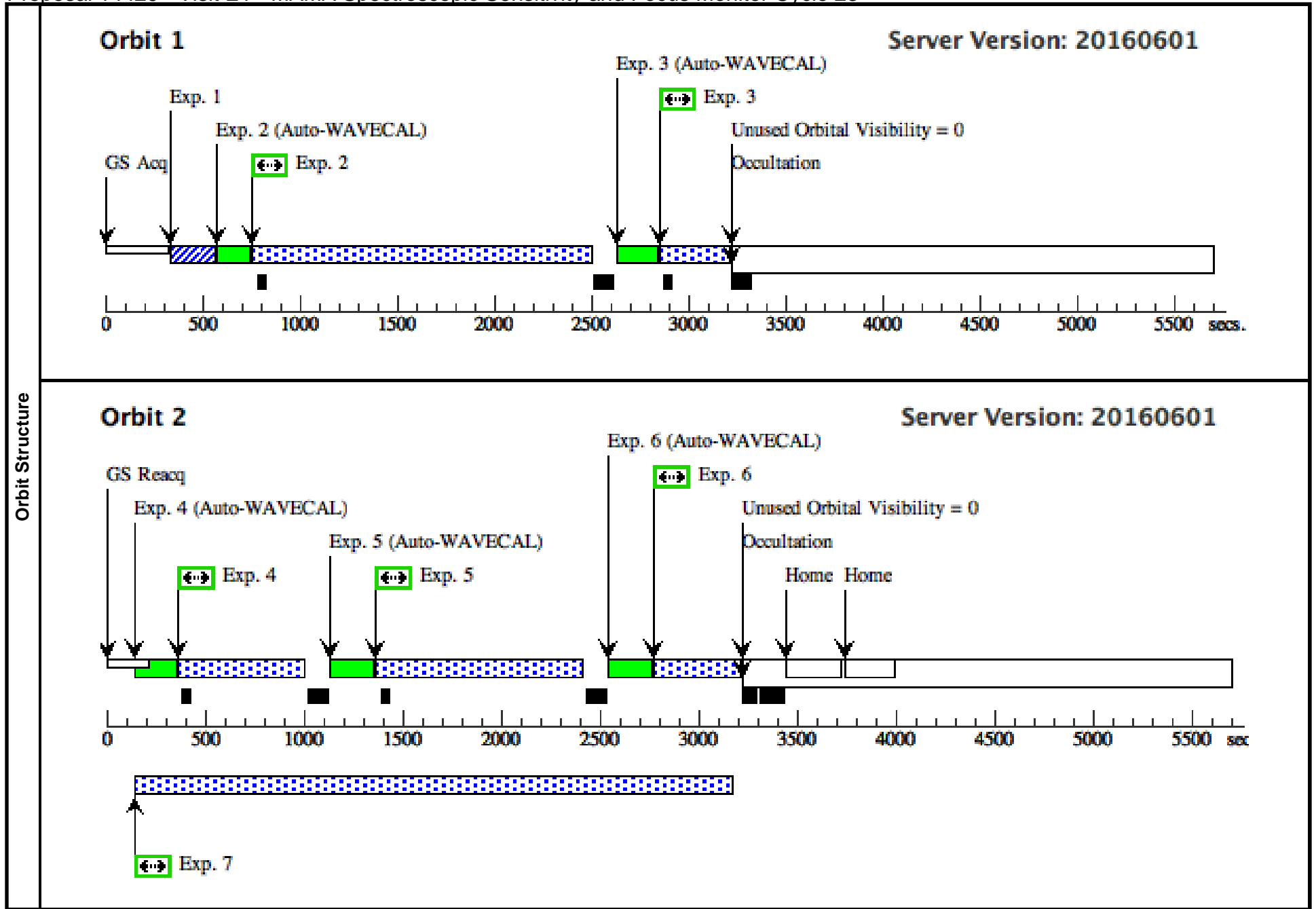

Proposal 14429 - Visit E2 - MAMA Spectroscopic Sensitivity and Focus Monitor Cycle 23

Wed Sep 07 21:27:24 GMT 2016

Visit	Proposal 14429, Visit E2, completed Diagnostic Status: Warning Scientific Instruments: STIS/NUV-MAMA, STIS/CCD, COS/FUV, STIS/FUV-MAMA Special Requirements: ORIENT 25D TO 28 D; ORIENT 30D TO 35 D; ORIENT 38D TO 41 D; BETWEEN 01-JAN-2016:00:00:00 AND 08-FEB-2016:00:00:00 Comments: E-modes + Focus Please schedule this visit in an SAA-free block if possible.									
	(Visit E2) Warning (Form): For the best data quality, it is strongly recommended that all four FP-POS positions be used when observing at a given COS CENWAVE setting.									
Fixed Targets	#	Name	Target Coordinates	Targ. Coord. Corrections	Fluxes	Miscellaneous				
	(3)	BD+28D4211	RA: 21 51 11.0200 (327.7959167d) Dec: +28 51 50.40 (28.86400d) Equinox: J2000	Proper Motion RA: -0.0026 sec of time/yr Proper Motion Dec: -0.056 arcsec/yr Epoch of Position: 2000.0	V=10.51+/-0.04 B-V = -0.34 F(2000)=9.42 +/- 0.001 e-12	Reference Frame: ICRS				
Exposures	#	Label (ETC Run)	Target	Config,Mode,Aperture	Spectral Els.	Opt. Params.	Special Reqs.	Groups	Exp. Time (Total)/[Actual Dur.]	Orbit
	1	ACQ (STIS.ta.636 593)	(3) BD+28D4211	STIS/CCD, ACQ, F28X50LP	MIRROR				0.1 Secs (0.1 Secs) [==>]	[1]
	2	E230H (STIS.sp.63 6584)	(3) BD+28D4211	STIS/NUV-MAMA, ACCUM, 0.2X0.2	E230H 2263 A				1732 Secs (1732 Secs) [==>]	[1]
	3	E140M (STIS.sp.63 6585)	(3) BD+28D4211	STIS/FUV-MAMA, ACCUM, 0.2X0.2	E140M 1425 A				346 Secs (346 Secs) [==>]	[1]
	4	E230M (STIS.sp.63 6592)	(3) BD+28D4211	STIS/NUV-MAMA, ACCUM, 0.2X0.2	E230M 1978 A			Prime + Parallel Group 4-7 in Visit E2	628 Secs (628 Secs) [==>]	[2]
	5	E140H (STIS.sp.63 6588)	(3) BD+28D4211	STIS/FUV-MAMA, ACCUM, 0.2X0.2	E140H 1416 A			Prime + Parallel Group 4-7 in Visit E2	1034 Secs (1034 Secs) [==>]	[2]
	6	E230M (STIS.sp.63 6589)	(3) BD+28D4211	STIS/NUV-MAMA, ACCUM, 0.2X0.2	E230M 2707 A			Prime + Parallel Group 4-7 in Visit E2	422 Secs (422 Secs) [==>]	[2]
	7	(COS.sp.745 935)	ANY	COS/FUV, TIME-TAG, PSA	G130M 1327 A	BUFFER-TIME=46 50; FP-POS=4		Prime + Parallel Group 4-7 in Visit E2	2900.0 Secs (2900 Secs) [==>]	[2]
<i>Comments: Expand</i>										

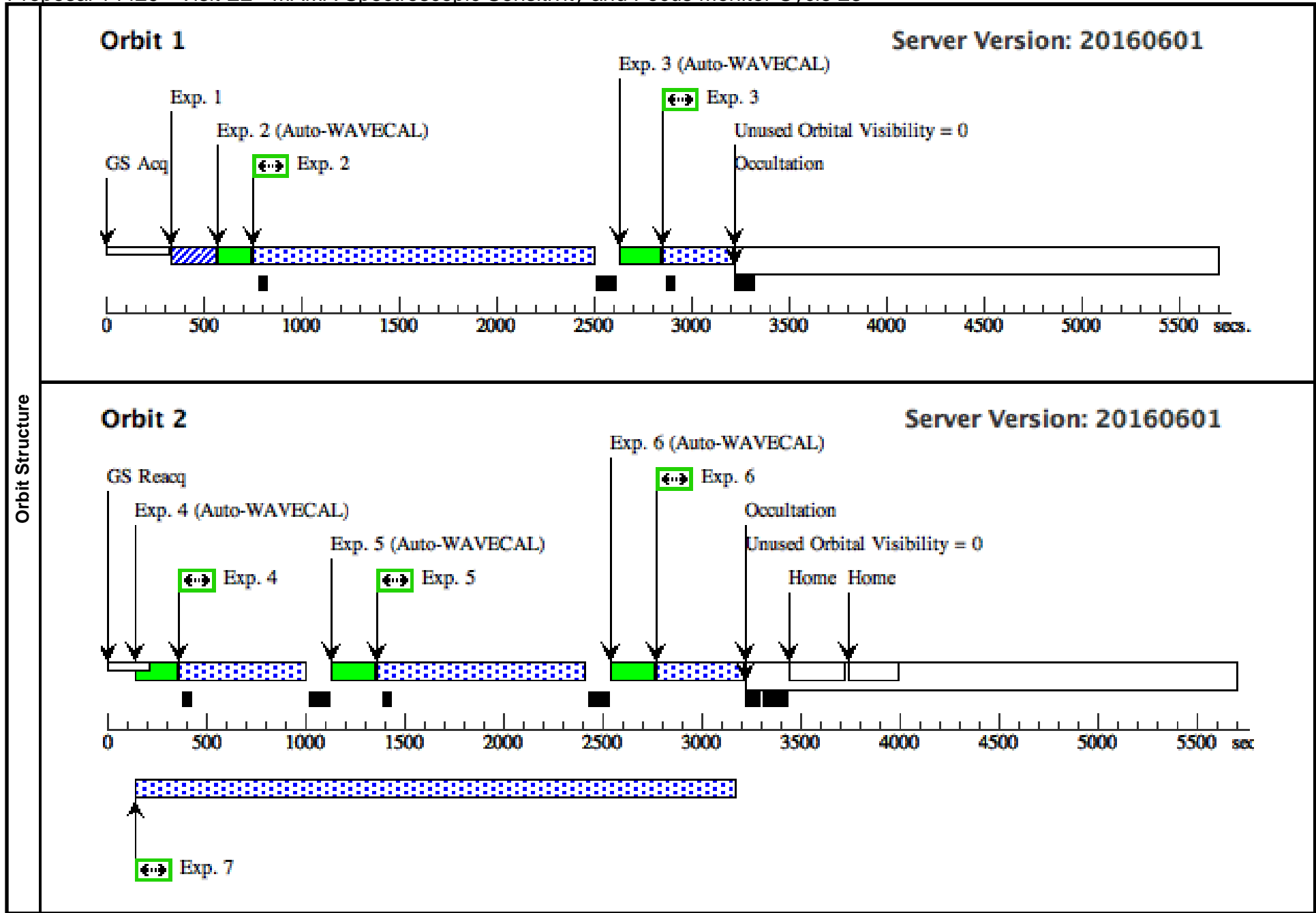

Proposal 14429 - Visit E3 - MAMA Spectroscopic Sensitivity and Focus Monitor Cycle 23

Wed Sep 07 21:27:24 GMT 2016

Visit	Proposal 14429, Visit E3, completed Diagnostic Status: Warning Scientific Instruments: STIS/NUV-MAMA, STIS/CCD, COS/FUV, STIS/FUV-MAMA Special Requirements: ORIENT 250D TO 251.2 D; BETWEEN 25-APR-2016:00:00:00 AND 20-MAY-2016:00:00:00 Comments: E-modes + Focus Please schedule this visit in an SAA-free block if possible.									
	(Visit E3) Warning (Form): For the best data quality, it is strongly recommended that all four FP-POS positions be used when observing at a given COS CENWAVE setting.									
Fixed Targets	#	Name	Target Coordinates	Targ. Coord. Corrections	Fluxes	Miscellaneous				
	(3)	BD+28D4211	RA: 21 51 11.0200 (327.7959167d) Dec: +28 51 50.40 (28.86400d) Equinox: J2000	Proper Motion RA: -0.0026 sec of time/yr Proper Motion Dec: -0.056 arcsec/yr Epoch of Position: 2000.0	V=10.51+/-0.04 B-V = -0.34 F(2000)=9.42 +/- 0.001 e-12	Reference Frame: ICRS				
Exposures	#	Label (ETC Run)	Target	Config,Mode,Aperture	Spectral Els.	Opt. Params.	Special Reqs.	Groups	Exp. Time (Total)/[Actual Dur.]	Orbit
	1	ACQ (STIS.ta.636 593)	(3) BD+28D4211	STIS/CCD, ACQ, F28X50LP	MIRROR				0.1 Secs (0.1 Secs) [==>]	[1]
	2	E230H (STIS.sp.63 6584)	(3) BD+28D4211	STIS/NUV-MAMA, ACCUM, 0.2X0.2	E230H 2263 A				1732 Secs (1732 Secs) [==>]	[1]
	3	E140M (STIS.sp.63 6585)	(3) BD+28D4211	STIS/FUV-MAMA, ACCUM, 0.2X0.2	E140M 1425 A				346 Secs (346 Secs) [==>]	[1]
	4	E230M (STIS.sp.63 6592)	(3) BD+28D4211	STIS/NUV-MAMA, ACCUM, 0.2X0.2	E230M 1978 A			Prime + Parallel Group 4-7 in Visit E3	628 Secs (628 Secs) [==>]	[2]
	5	E140H (STIS.sp.63 6588)	(3) BD+28D4211	STIS/FUV-MAMA, ACCUM, 0.2X0.2	E140H 1416 A			Prime + Parallel Group 4-7 in Visit E3	1034 Secs (1034 Secs) [==>]	[2]
	6	E230M (STIS.sp.63 6589)	(3) BD+28D4211	STIS/NUV-MAMA, ACCUM, 0.2X0.2	E230M 2707 A			Prime + Parallel Group 4-7 in Visit E3	422.0 Secs (422 Secs) [==>]	[2]
	7	(COS.sp.636 580)	ANY	COS/FUV, TIME-TAG, PSA	G130M 1291 A	BUFFER-TIME=46 50; FP-POS=3		Prime + Parallel Group 4-7 in Visit E3	2900.0 Secs (2900 Secs) [==>]	[2]

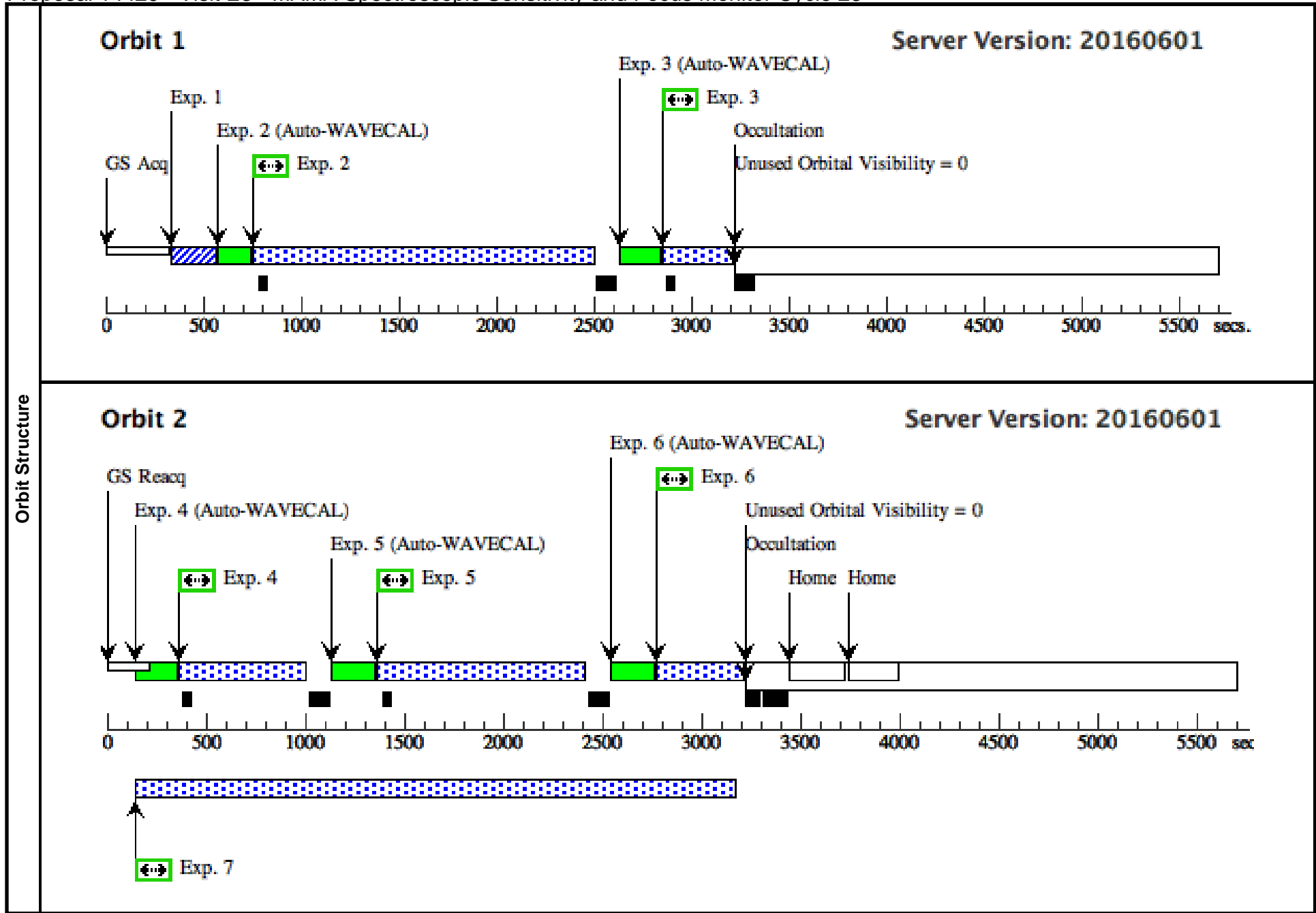

Proposal 14429 - Visit E4 - MAMA Spectroscopic Sensitivity and Focus Monitor Cycle 23

Wed Sep 07 21:27:24 GMT 2016

Visit	Proposal 14429, Visit E4, scheduling Diagnostic Status: Warning Scientific Instruments: STIS/NUV-MAMA, STIS/CCD, COS/FUV, STIS/FUV-MAMA Special Requirements: ORIENT 121D TO 128 D; BETWEEN 12-SEP-2016:00:00:00 AND 03-OCT-2016:00:00:00 Comments: E-modes + Focus Please schedule this visit in an SAA-free block if possible.									
	(Visit E4) Warning (Form): For the best data quality, it is strongly recommended that all four FP-POS positions be used when observing at a given COS CENWAVE setting.									
Fixed Targets	#	Name	Target Coordinates	Targ. Coord. Corrections	Fluxes	Miscellaneous				
	(3)	BD+28D4211	RA: 21 51 11.0200 (327.7959167d) Dec: +28 51 50.40 (28.86400d) Equinox: J2000	Proper Motion RA: -0.0026 sec of time/yr Proper Motion Dec: -0.056 arcsec/yr Epoch of Position: 2000.0	V=10.51+/-0.04 B-V = -0.34 F(2000)=9.42 +/- 0.001 e-12	Reference Frame: ICRS				
Exposures	#	Label (ETC Run)	Target	Config,Mode,Aperture	Spectral Els.	Opt. Params.	Special Reqs.	Groups	Exp. Time (Total)/[Actual Dur.]	Orbit
	1	ACQ (STIS.ta.636 593)	(3) BD+28D4211	STIS/CCD, ACQ, F28X50LP	MIRROR				0.1 Secs (0.1 Secs) [==>]	[1]
	2	E230H (STIS.sp.63 6584)	(3) BD+28D4211	STIS/NUV-MAMA, ACCUM, 0.2X0.2	E230H 2263 A				1732 Secs (1732 Secs) [==>]	[1]
	3	E140M (STIS.sp.63 6585)	(3) BD+28D4211	STIS/FUV-MAMA, ACCUM, 0.2X0.2	E140M 1425 A				346 Secs (346 Secs) [==>]	[1]
	4	E230M (STIS.sp.63 6592)	(3) BD+28D4211	STIS/NUV-MAMA, ACCUM, 0.2X0.2	E230M 1978 A			Prime + Parallel Group 4-7 in Visit E4	628 Secs (628 Secs) [==>]	[2]
	5	E140H (STIS.sp.63 6588)	(3) BD+28D4211	STIS/FUV-MAMA, ACCUM, 0.2X0.2	E140H 1416 A			Prime + Parallel Group 4-7 in Visit E4	1034 Secs (1034 Secs) [==>]	[2]
	6	E230M (STIS.sp.63 6589)	(3) BD+28D4211	STIS/NUV-MAMA, ACCUM, 0.2X0.2	E230M 2707 A			Prime + Parallel Group 4-7 in Visit E4	422.0 Secs (422 Secs) [==>]	[2]
	7	(COS.sp.636 580)	ANY	COS/FUV, TIME-TAG, PSA	G130M 1291 A	BUFFER-TIME=46 50; FP-POS=2		Prime + Parallel Group 4-7 in Visit E4	2900.0 Secs (2900 Secs) [==>]	[2]
<i>Comments: Expand</i>										

