

# Canon

## imageRUNNER™

# Copy User Guide

---

Black & White Equipment



## Table of Contents

---

<b>Feature</b>	<b>Page Number</b>
LCD Screen of Multifunctional Device	1
How to Copy	2
<b>Basic Copy Features</b>	
1. Copy Ratio	3
i. Preset Zoom	
ii. Zoom by Percentage	
iii. Auto Zoom	
iv. Entire Image	
2. Finisher (Collating Copies)	4
i. Collate	
ii. Group	
iii. Staple	
3. Paper Select	5
i. Stack Bypass	
4. Reservation Copies	6
5. Sample Set	7
6. Two-sided Copying	8
<b>Special Copy Features</b> (may vary with MFD model)	
7. Booklet	9
8. Divided Booklet	9
9. Cover Sheet Insertion	10
I. Front Cover	
II. Back Cover	
III. Chapter Page	
IV. Sheet Insertion	
10. Different-sized originals	11
11. Frame Erase	11
I. Original Frame	
II. Book Frame Erase	
III. Binding Erase	
12. Image Combination	12
I. 2 on 1	
II. 4 on 1	
III. 8 on 1	
13. Image Repeat	13
14. Job Build	14
15. Margin	14
16. Mirror Image	15
17. Mode Memory	15
18. Negative / Positive	15
19. Page & Copy Set Numbering	16
20. Printing a Watermark/Print Date	16
21. Job Recall	17
22. Sharpness	17
23. Shift	18
24. Transparency Interleaving	19
25. Two Page Separation	19

## LCD Screen on Multifunctional Device (MFD)

**NOTE:** Numbers correspond with Basic Copy Features listed in the Table of Contents.

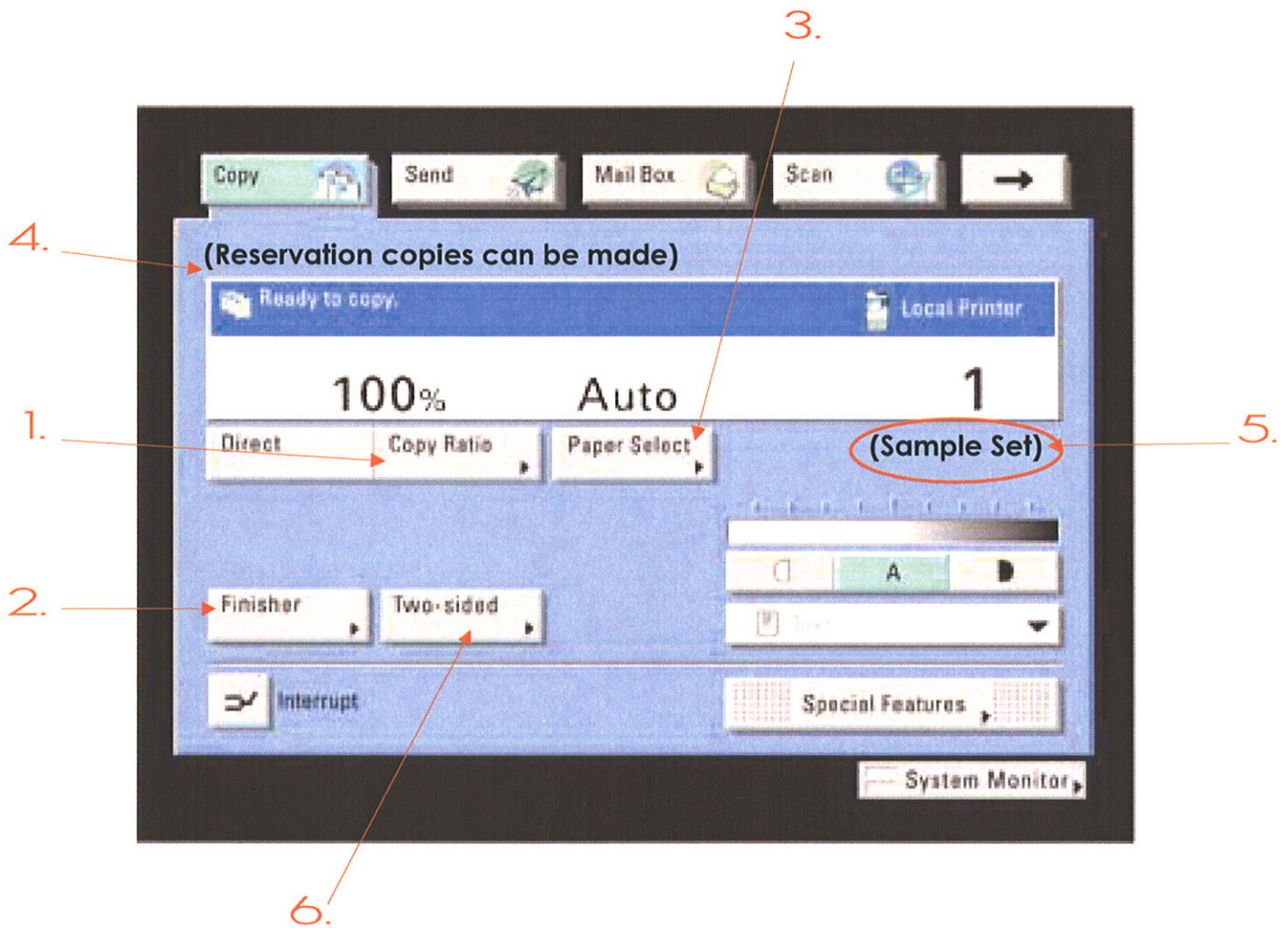

**NOTE:** Your MFD screen may vary slightly from above image.

## HOW TO COPY

1. Press <COPY> on the MFD.
2. Place originals face-up in the automatic document reader or face down on the glass.
3. Using the key pad, enter the desired number of copies.
4. If other functions are desired press <SPECIAL FEATURES> or <FINISHER> on the LCD panel
5. Press <START> to begin making copies.

\*Auto paper selection is the standard mode setting. To manually select paper size, press <PAPER SELECT> and choose the appropriate size.

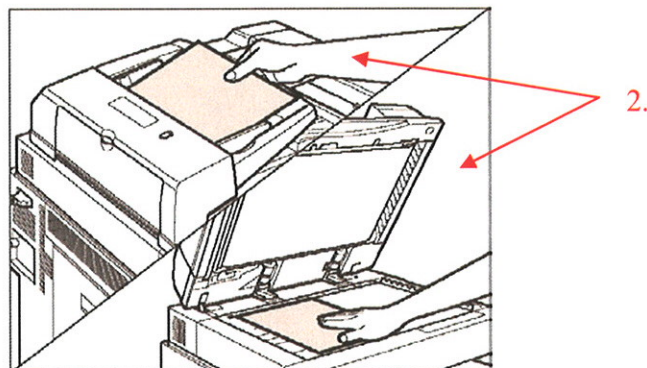

# Basic Copy Features

## 1. Copy Ratio

---

Set the machine to adjust the copy ratio automatically, or specify the copy ratio manually.

### Preset Zoom

The machine offers a variety of preset copy ratios to reduce or enlarge standard originals (ex: 8 ½ X 11) to another standard size (ex: 11 x 17).

### Zoom by Percentage

Reduces or enlarges originals by any copy ratio, in 1% increments.

### Auto Zoom

Sets the machine to automatically select the appropriate copy ratio based on the size of the original and selected copy paper.

### Entire Image

If you are copying an original with an image that extends all the way to the edges onto the same size paper at a copy ratio of 100%, the periphery of the original image may be cut off slightly on the copy. However, select the **Entire Image** mode to slightly reduce the original to fit the output page size.

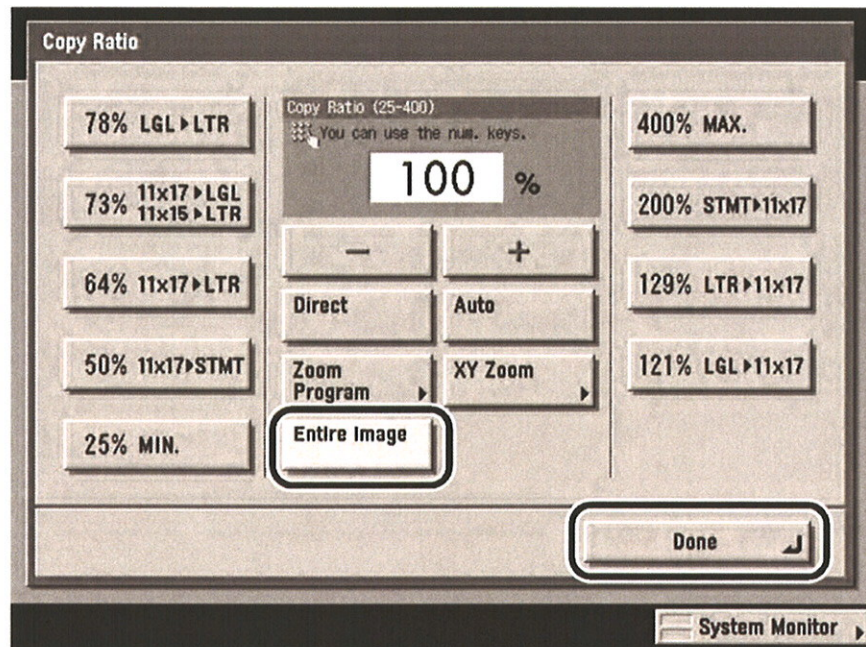

## 2. Finisher - Collating Copies

Select finisher modes to collate copies in various ways, either by pages or by copy sets.

**NOTE:** Your Finisher options may vary from the options listed in this guide. Select the Finisher button on your MFD to verify functionality.

### Collate

This feature is a default setting. Copies are automatically collated into sets arranged in page order.

### Group

Copies of the same original pages are grouped together.

### Staple

Depending on your finisher, you may be able to staple in the upper left-hand corner, or in any of the four corners and two on the side.

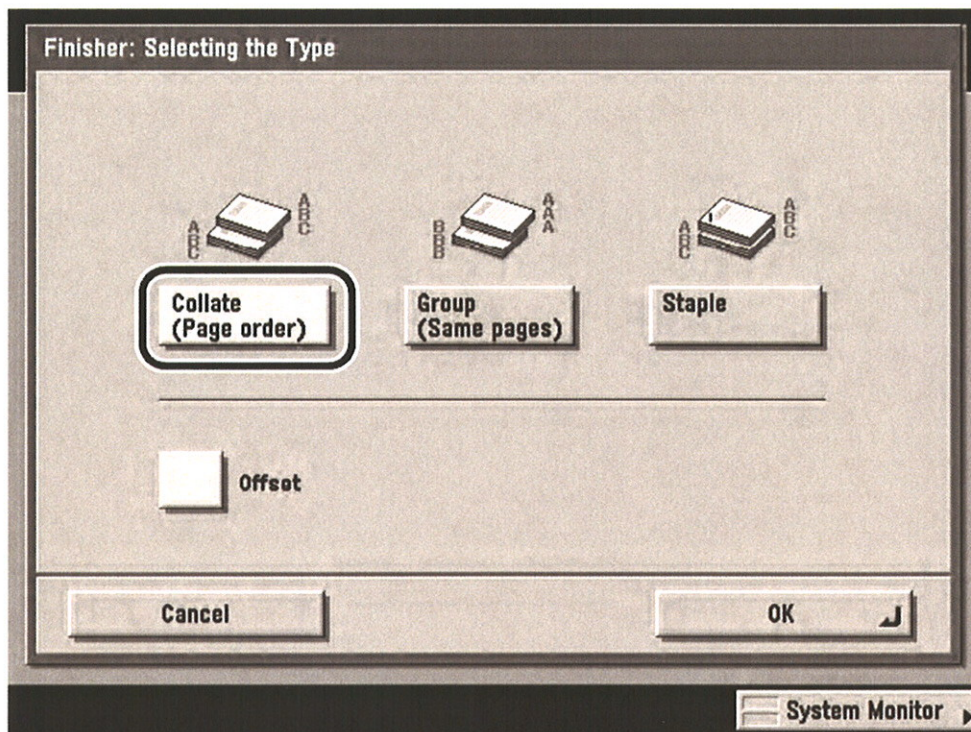

### 3. Paper Select

The MFD will automatically select the paper size when the platen glass is covered, however you can also manually specify a paper size.

#### Auto

Paper size will appear on the LCD screen once it has been placed in the feeder or on the glass.

**NOTE:** *If you are copying from the glass, you must close the top cover for the machine to recognize page size.*

#### Paper Select (manually)

Manually select paper sizes when copying originals to a different sized paper or when using the stack bypass. When placing paper in the stack bypass, you will be prompted to select paper size.

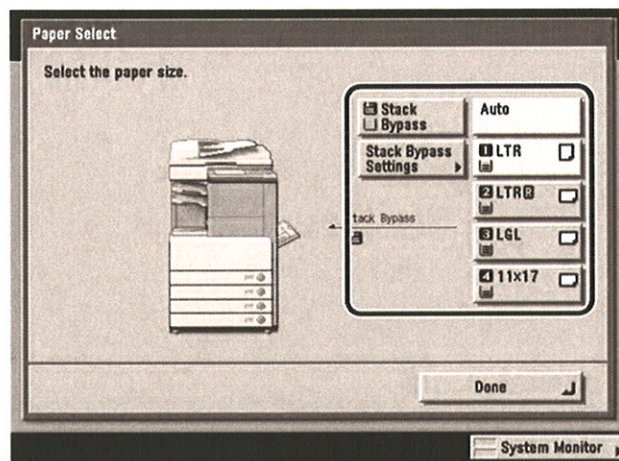

**NOTE:** *Once page size has been selected automatically or manually, specified page size will appear above the Paper Select button.*

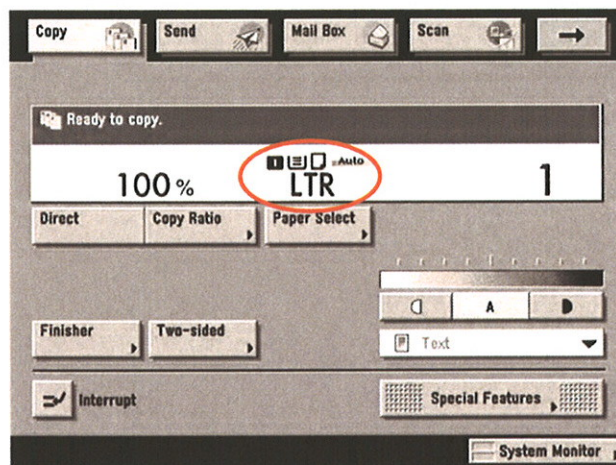

## 4. Reservation Copies

Set the machine to scan originals even while the machine is printing or waiting to process a job. You can reserve up to five copy jobs, including the current job.

You can set different copy modes and paper sources, including the stack bypass, for each reserved job.

Reserved printing can be specified in the following cases.

### While the Machine is Waiting

Specify copy settings or scan originals while the machine is in the waiting mode, such as when the power has just been turned ON, or after a paper jam is cleared. Copying automatically begins when the machine is ready.

The message **Reservation copies can be made** appears on the LCD screen when the machine is able to process reserved copying.

### While the Machine is Printing

Specify copy settings for a new job while the machine is printing. Copying of the new job automatically begins when the current job is complete.

1. Press **Done** on the pop-up screen that appears while the machine is printing.
2. Place your originals and select the desired copy modes.
3. Press Start.

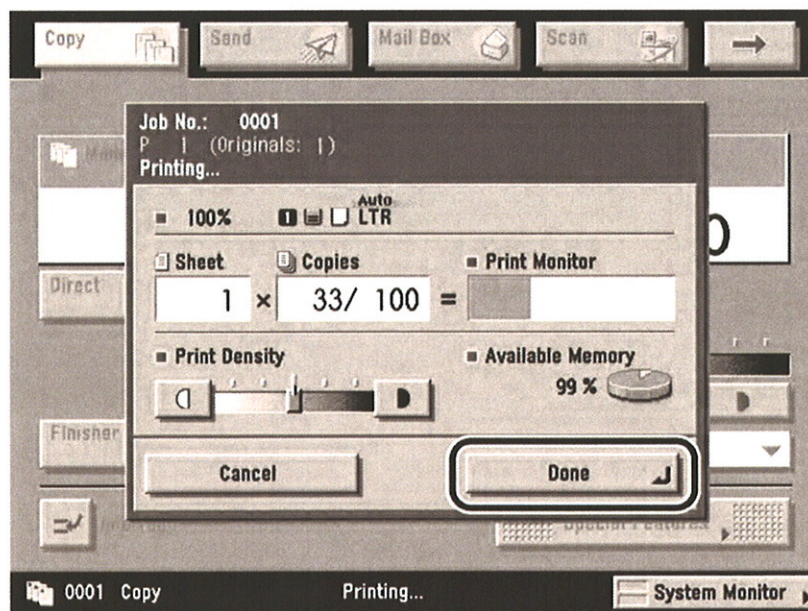

## 5. Sample Set

This mode enables you to check the copy result before making multiple copies.

**IMPORTANT:** *Sample Set appears only if you make multiple copies of your original in the Collate, Offset Collate, Rotate Collate, Staple, Cover/Sheet Insertion, Booklet, or Transparency Interleaving mode. Sample Set will not appear if the Group mode is set.*

1. Place your originals and select the desired copy modes.
2. Press **Sample Set**.
3. Press Start.

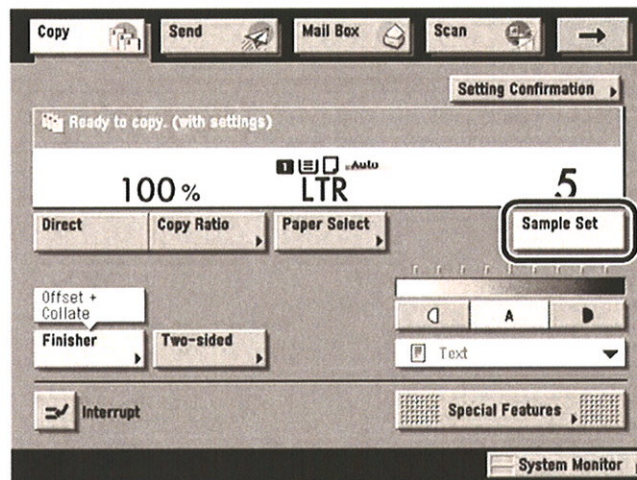

4. Check your sample set, you will have the option to **Start Print**, **Cancel**, or **Change Settings**.

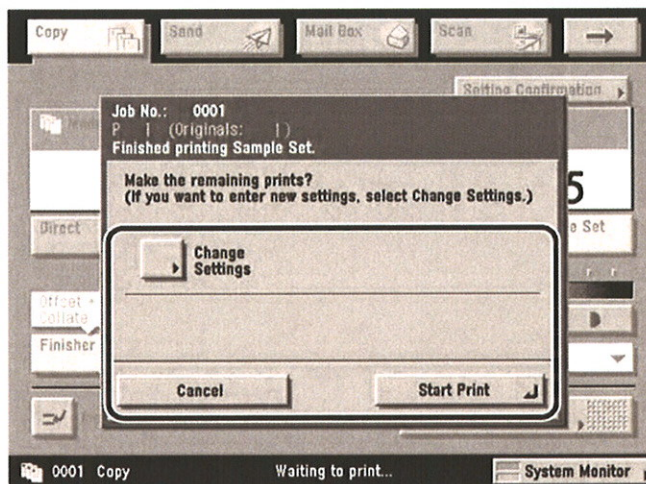

## 6. Two-Sided Copying

---

Make two-sided copies from one-sided or two-sided originals, or make one-sided copies from two sided originals.

### 1 to 2-Sided

This feature enables you to make two-sided copies from one-sided originals.

### 2 to 2-Sided

This feature enables you to make two-sided copies from two-sided originals. If originals are placed in the feeder, they are automatically turned over to make two-sided copies.

### 2 to 1-Sided

This feature automatically turns over two-sided originals placed in the feeder to make one-sided copies on different sheets of paper.

### Book to 2-Sided

This feature enables you to make two-sided copies from facing pages, or from the front and back sides of a page in bound originals, such as books and magazines.

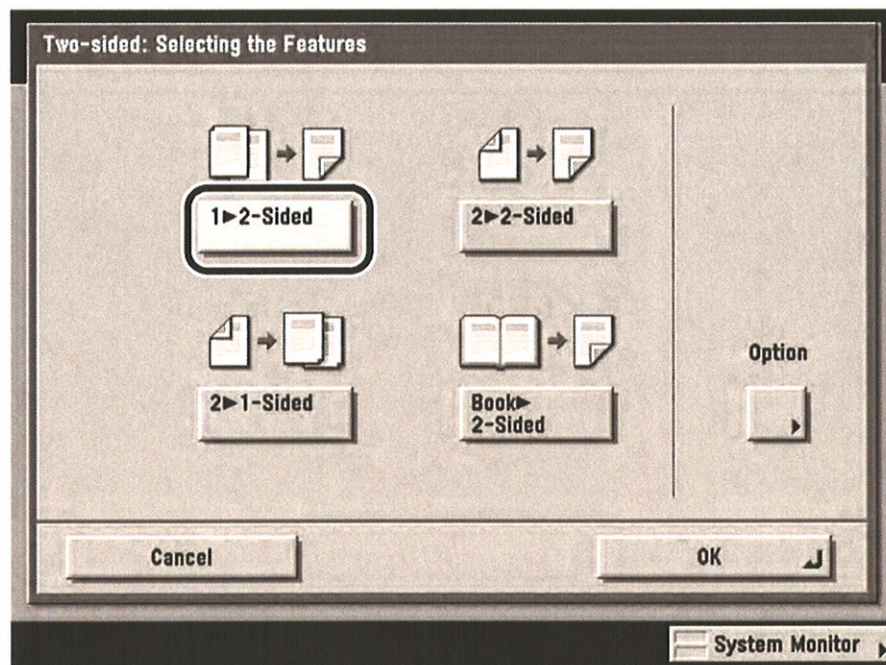

## Special Copy Features

### 7. Booklet

---

Booklet allows users to copy a single-sided or double-sided original in such a way that a booklet is created when a copy is folded in half.

**EXAMPLES:**

1. Menus, brochures, programs, invitations
2. Company newsletters, training manuals, user guides

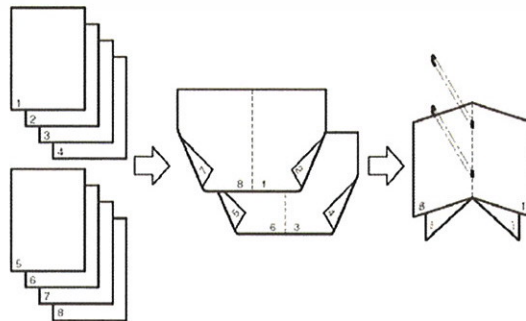

### 8. Divided Booklet

---

Enables you to copy a document with many pages and create multiple sub-booklets (with each sub-booklet using up to 15 sheets of paper).

Since the Saddle Finisher can only fold a maximum of 15 sheets of paper, this mode will allow all of the output for a large document to be folded, which would not be possible with the booklet mode mentioned above.

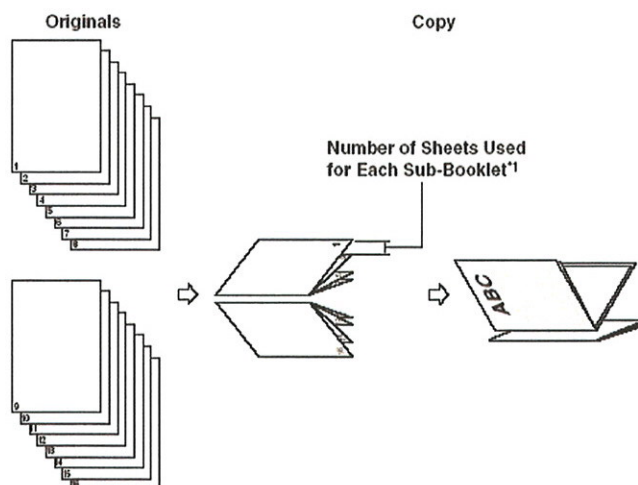

## 9. Cover Sheet/Insertion

Set the machine to automatically add front and back covers, and sheet insertions or chapter pages using a different type of paper from that used for the copies. Additionally, you can decide whether the front and back covers, and the sheet insertions are copied on or left blank. Chapter pages are always copied on.

**NOTE:** If you are copying on the front cover, back cover, or sheet insertions, these sheets are counted in the total number of copies made. However, if these sheets are left blank, the machine's counter does not count them as copies.

### Front Cover and Back Cover



### Chapter Page and Sheet Insertion

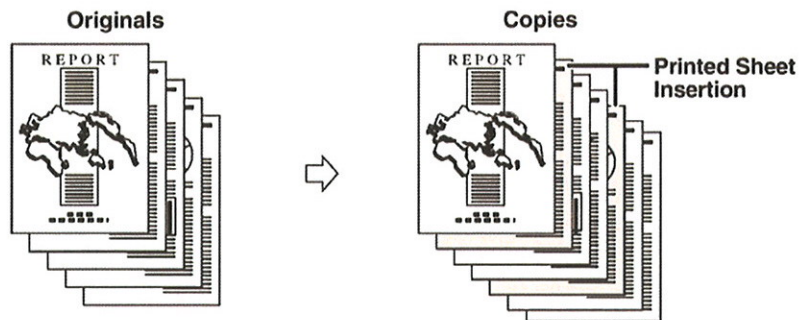

## 10. Different-Sized Originals

Different-sized originals can be placed together, provided the leading edge of each page is the same length.

**NOTE:** When copying letter and legal sized paper, you must have a letter paper tray and a legal paper tray.

### EXAMPLES:

1. Use all documents in the same job, rather than running two different paper sizes as separate jobs.
2. Packets of information, such as HR new-hire documents may have some legal-sized documents.

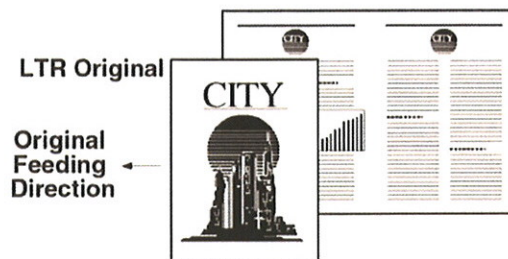

## 11. Frame Erase

Frame Erase eliminates shadows and dark lines to create clean copies of odd-size originals, bound documents, originals with ragged edges, hole punches, or notes in the margin. Three erase modes are accessible within Frame Erase.

### EXAMPLES:

1. Pages from a small book, note pad, magazine
2. 3-hole punched sheets of paper

### Original Frame Erase

Eliminates dark borders and lines that appear on the copies when the original is smaller than the selected paper size.

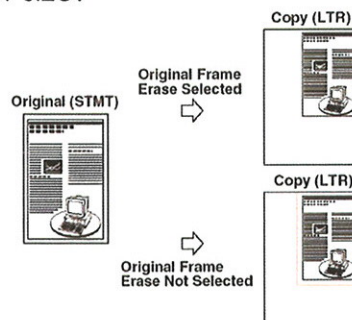

### Book Frame Erase

Erases the gray shadows and lines that appear when copying from a book.

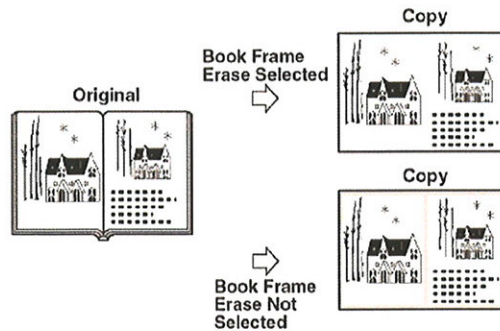

### Binding Erase

Erases the shadows that appear in copies from binding holes in originals.

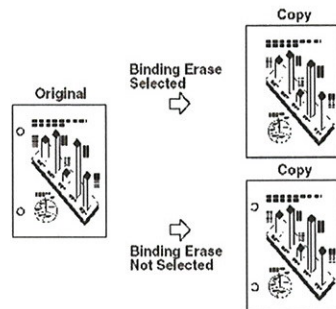

## 12. Image Combination

---

Image combination enables you to automatically reduce two, four, or eight originals to fit on a single-sided or two-sided copy sheet.

### **EXAMPLES:**

1. For presentation handouts, create thumbnails of each image in your presentation.
2. Save paper and storage space by storing up to 16 documents on one page (8 on each side)

### 2 on 1

Reduces two 1-sided originals or one 2-sided original to fit on one side or both sides of the sheet.

[2 On 1] Is Selected

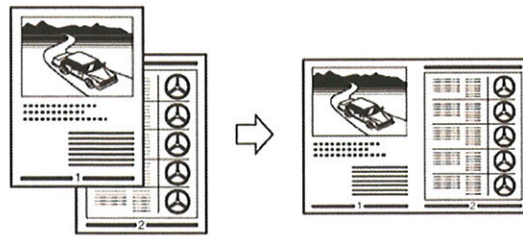

### 4 on 1

Reduces four 1-sided or two 2-sided originals to fit on one side or both sides of a sheet.

### 8 on 1

Reduces eight 1-sided or four 2-sided originals to fit on one side or both sides of the sheet.

## 13. Image Repeat

---

Copy the image of an original multiple times in either a length-wise or width-wise direction.

### **EXAMPLES:**

1. Business cards
2. Labels

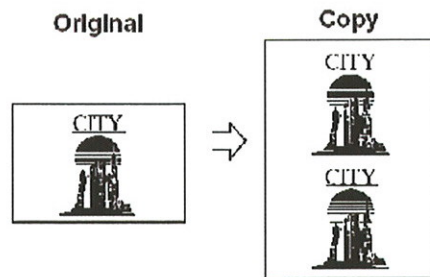

### Automatic Setting

The original image is copied so that the minimal possible number of copies fit on the selected paper size.

### Manual Setting

The original image is copied for the specified number of times

## 14. Job Build

---

Job Build enables you to scan originals that are beyond the maximum number of originals the feeder can hold, by dividing them into multiple batches. The originals are copied as one document after all the bunches have been scanned.

**NOTE:** You can use both the feeder and the platen glass for one copy job.

**EXAMPLES:**

1. Documents with more pages than the feeder can hold
2. Combine images or pages from separate documents

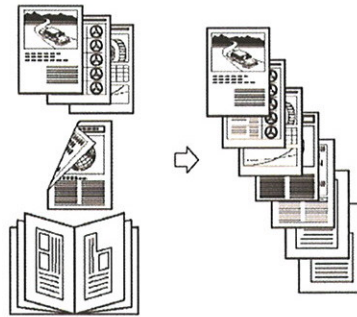

## 15. Margin

---

Margin enables you to make copies with an entire image shifted to the left, right, top or bottom of a sheet.

**EXAMPLES:**

1. Eliminate the top lines of a fax
2. Set copies for binding or using a three-hole punch so that your printed data will not be cut off.

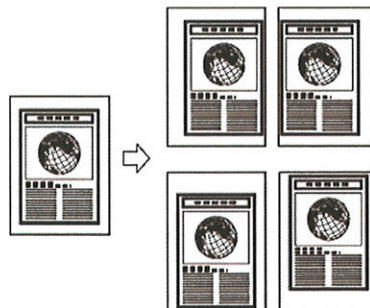

## 16. Mirror Image

---

Mirror Image copies the image as if reflected in a mirror, reversing the right and left sides.

**EXAMPLES:**

1. Copy an image onto a transparency or copy a transparency onto a regular sheet of paper.
2. Transparent signs, clear stickers.

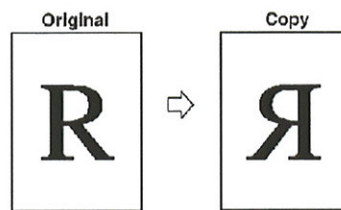

## 17. Mode Memory

---

Store frequently used copy settings and recall them for job use. A name may be assigned to the stored settings.

**EXAMPLES:**

1. Reports printed frequently
2. Regularly used documents

## 18. Negative/Positive

---

Negative/Positive inverts everything from the original that is black to white and everything white to black.

**EXAMPLES:**

1. Save toner by inverting heavily imaged areas
2. Make text easier to read
3. Use for editing purposes

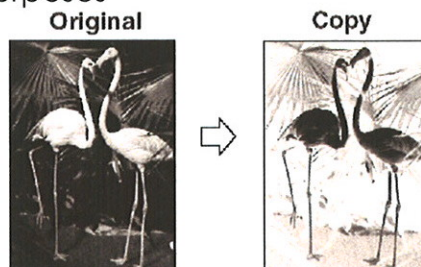

## 19. Page & Copy Set Numbering

---

### Page Numbering

Make a copy with page numbers (numbers only, numbers enclosed by hyphens, chapter numbers, or the total page count).



### Copy Set Numbering

Print a document with a different five digit number per copy set in the background of each page to differentiate the copy sets.

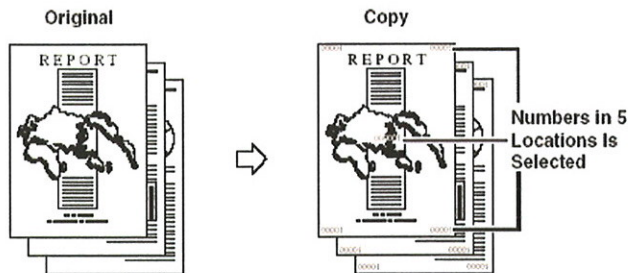

## 20. Printing a Watermark and Date

(Available only on 30 and 70 series machines)

---

### Watermark

Print a preset or user-defined watermark on your copies.

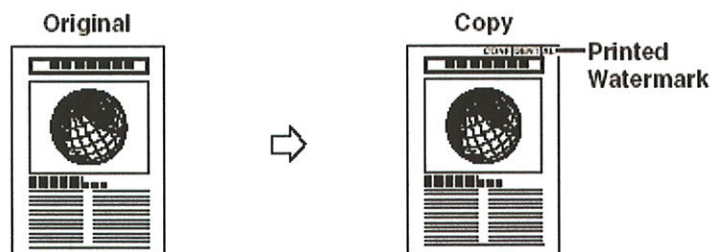

## Print Date

Print the date on your copies.

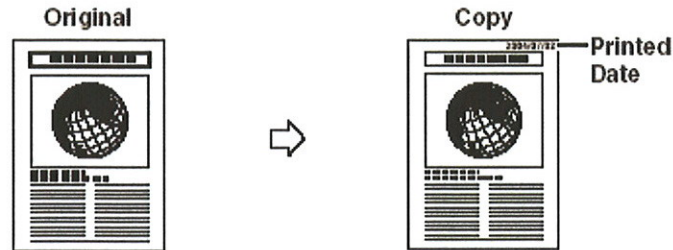

## 21. Recall

---

Recall stores and retrieves the last three copy settings used on the copier.

### **EXAMPLES:**

1. You didn't print enough copies and need to use the same settings
2. After finishing a job, you realize you must print the document again with corrections

## 22. Sharpness

---

Select a level of sharpness to make the document more legible.

### **EXAMPLES:**

1. Photographic images in news papers or magazines
2. Blueprints or faint pencil-drawn originals
3. For more defined outlines of charts, graphs, photos

### Low

If you make copies of an original containing half-tones, such as a printed photograph using the Photo mode, screen clash may occur. However, by using "Low," you can soften this moiré effect so that the copy is easier on the eyes.

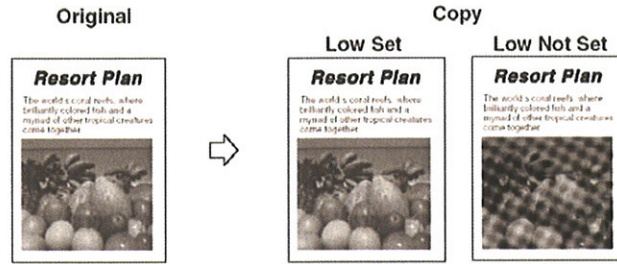

## High

This feature enhances the edges of original images so that the text is reproduced more sharply. This is particularly suited to blueprints or faint pencil-drawn originals

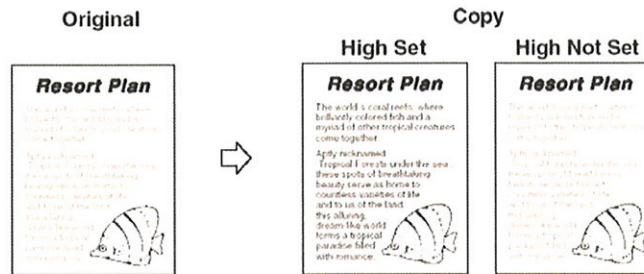

## 23. Shift

Shift moves an image to the center, any corner, or any side of a sheet.

**NOTE:** If the original and the copy paper are the same size and the copy ratio is set at 100%, the original of the image is not shifted.

### EXAMPLES:

1. If copying onto 11x17, this feature will shift the image to the desired location on the page.
2. Shift images such as company logo.



## 24. Transparency Interleaving

---

Transparency Interleaving inserts a sheet of blank or printed paper between each transparency.

**EXAMPLES:**

1. Interleaving paper prevents transparencies from sticking together.
2. Create a set of notes to correspond with transparencies.

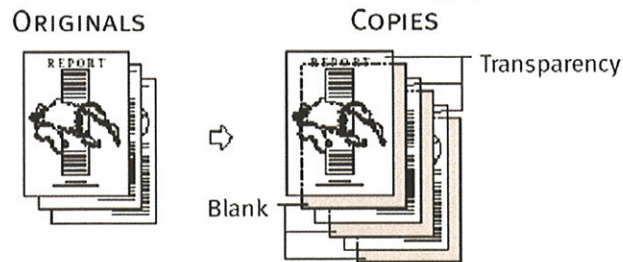

Blank

Outputs copied transparencies and blank interleaf sheets alternately.

Printed

Outputs copied transparencies and printed interleaf sheets alternately.

## 25. Two-Page Separation

---

When copying from a book, Two Page Separation will print each page to a separate sheet of paper.

**EXAMPLES:**

1. Copy pages of a bound book or magazine onto separate sheets of paper.
2. Avoid using over-sized paper to fit both pages of an open book.

